

TOSHIBA LED LAMP

**TLRE1100 (T11), TLSE1100 (T11), TLOE1100 (T11)
 TLYE1100 (T11), TLGE1100 (T11), TLPGE1100 (T11)**

PANEL CIRCUIT INDICATOR

Unit in mm

- Surface Mount Device
- 3.2 (L) × 2.8 (W) × 1.9 (H) mm Size
- Flat-top Type
- InGaAlP LED
- Available of Automounting Machine Use
- Low Drive Current, High Intensity Light Emission
- Applications : Automotive use, Message Signboard, Backlight, etc.
- Standard embossed taping : T11 (2000 pcs / reel)
8 mm tape reel

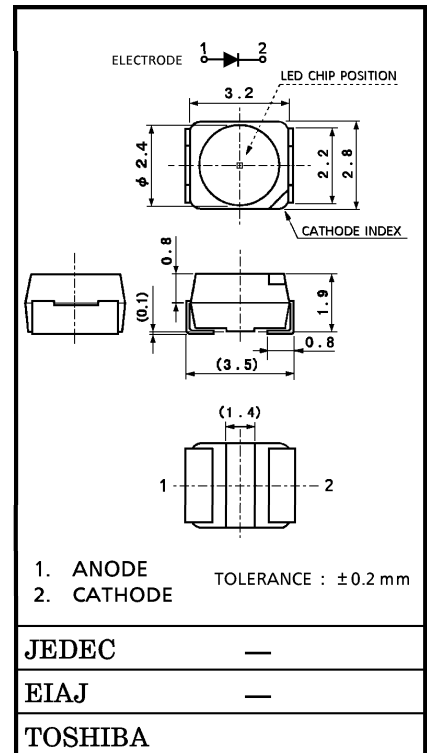

Weight : 35 mg

LINE-UP

PRODUCT NAME	COLOR	MATERIAL
TLRE1100	Red	InGaAlP
TLSE1100	Red	InGaAlP
TLOE1100	Orange	InGaAlP
TLYE1100	Yellow	InGaAlP
TLGE1100	Green	InGaAlP
TLPGE1100	Pure Green	InGaAlP

MAXIMUM RATINGS (Ta = 25°C)

PRODUCT NAME	FORWARD CURRENT I _F (mA)	REVERSE VOLTAGE V _R (V)	POWER DISSIPATION P _D (mW)	OPERATING TEMPERATURE T _{opr} (°C)	STORAGE TEMPERATURE T _{stg} (°C)
TLRE1100	50	4	120	-40~100	-40~100
TLSE1100	50	4	120		
TLOE1100	50	4	120		
TLYE1100	50	4	120		
TLGE1100	50	4	120		
TLPGE1100	50	4	120		

000707EAC2

- TOSHIBA is continually working to improve the quality and reliability of its products. Nevertheless, semiconductor devices in general can malfunction or fail due to their inherent electrical sensitivity and vulnerability to physical stress. It is the responsibility of the buyer, when utilizing TOSHIBA products, to comply with the standards of safety in making a safe design for the entire system, and to avoid situations in which a malfunction or failure of such TOSHIBA products could cause loss of human life, bodily injury or damage to property. In developing your designs, please ensure that TOSHIBA products are used within specified operating ranges as set forth in the most recent TOSHIBA products specifications. Also, please keep in mind the precautions and conditions set forth in the "Handling Guide for Semiconductor Devices," or "TOSHIBA Semiconductor Reliability Handbook" etc..
- The TOSHIBA products listed in this document are intended for usage in general electronics applications (computer, personal equipment, office equipment, measuring equipment, industrial robotics, domestic appliances, etc.). These TOSHIBA products are neither intended nor warranted for usage in equipment that requires extraordinarily high quality and/or reliability or a malfunction or failure of which may cause loss of human life or bodily injury ("Unintended Usage"). Unintended Usage include atomic energy control instruments, airplane or spaceship instruments, transportation instruments, traffic signal instruments, combustion control instruments, medical instruments, all types of safety devices, etc.. Unintended Usage of TOSHIBA products listed in this document shall be made at the customer's own risk.
- Gallium arsenide (GaAs) is a substance used in the products described in this document. GaAs dust and fumes are toxic. Do not break, cut or pulverize the product, or use chemicals to dissolve them. When disposing of the products, follow the appropriate regulations. Do not dispose of the products with other industrial waste or with domestic garbage.
- The information contained herein is presented only as a guide for the applications of our products. No responsibility is assumed by TOSHIBA CORPORATION for any infringements of intellectual property or other rights of the third parties which may result from its use. No license is granted by implication or otherwise under any intellectual property or other rights of TOSHIBA CORPORATION or others.
- The information contained herein is subject to change without notice.

ELECTRICAL CHARACTERISTICS (Ta = 25°C)

PRODUCT NAME	FORWARD VOLTAGE V _F				REVERSE CURRENT I _R	
	MIN	TYP.	MAX	I _F	MAX	V _R
TLRE1100	—	1.9	2.4	20	50	4
TLSE1100	—	1.9	2.4	20	50	4
TLOE1100	—	2.0	2.4	20	50	4
TLYE1100	—	2.0	2.4	20	50	4
TLGE1100	—	2.0	2.4	20	50	4
TLPGE1100	—	2.1	2.4	20	50	4
Unit	V			mA	μA	V

OPTICAL CHARACTERISTICS-1 (Ta = 25°C)

PRODUCT NAME	LUMINOUS INTENSITY I _V			I _F
	MIN	TYP.	MAX	
TLRE1100	47.6	100	—	20
TLSE1100	47.6	180	—	20
TLOE1100	47.6	180	—	20
TLYE1100	47.6	150	—	20
TLGE1100	47.6	100	—	20
TLPGE1100	8.50	25	—	20
Unit	mcd			mA

OPTICAL CHARACTERISTICS-2 (Ta = 25°C)

PRODUCT NAME	EMISSION SPECTRUM							I _F
	Peak Emission Wavelength λ _p			Δλ TYP.	Dominant Wavelength λ _d			
	MIN	TYP.	MAX		MIN	TYP.	MAX	
TLRE1100	—	(644)	—	(20)	—	630	—	20
TLSE1100	—	(623)	—	(20)	—	613	—	20
TLOE1100	—	(612)	—	(20)	—	605	—	20
TLYE1100	—	(590)	—	(17)	—	587	—	20
TLGE1100	—	(574)	—	(17)	—	571	—	20
TLPGE1100	—	(562)	—	(14)	—	558	—	20
UNIT	nm			nm	nm			mA

(Note) : This visible LED lamp also emits some IR light.
 If a photodetector is located near the LED lamp, please ensure that it will not be affected by this IR light.

TLRE1100

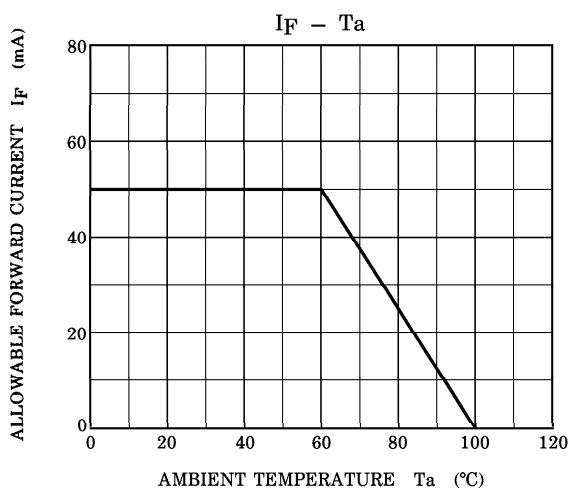
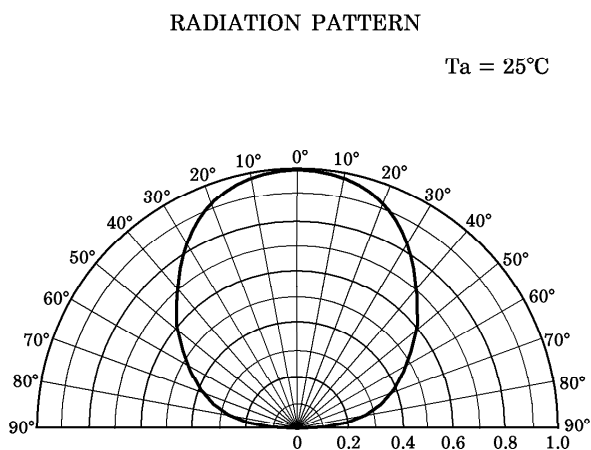
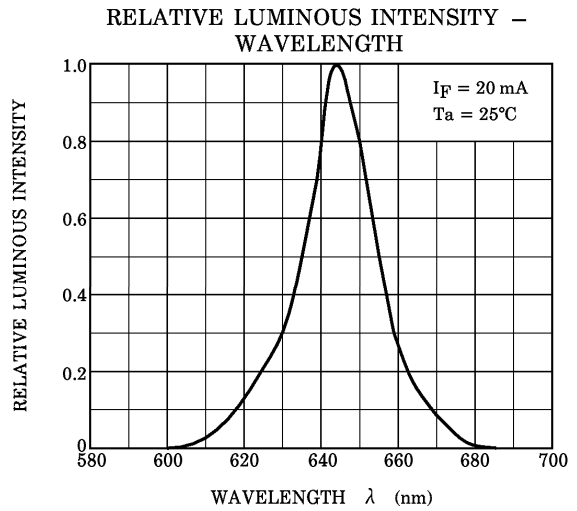
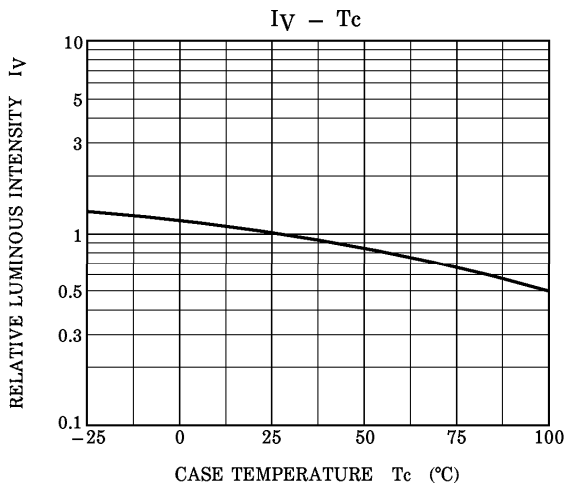
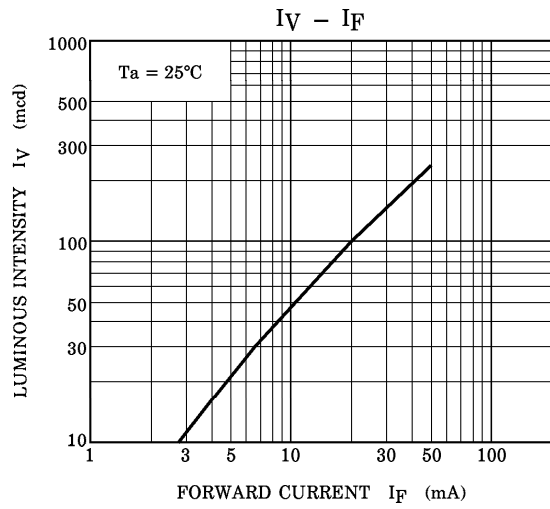
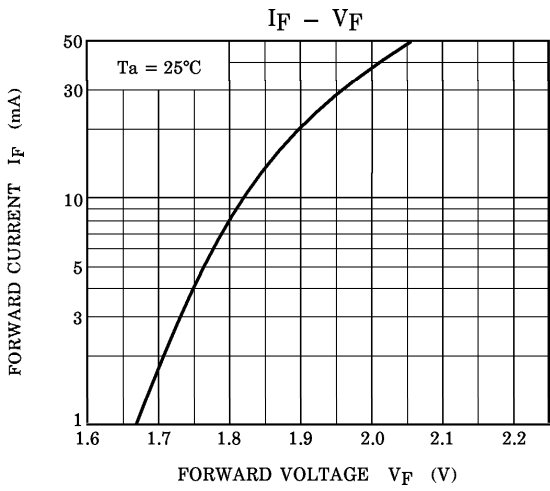

TLSE1100

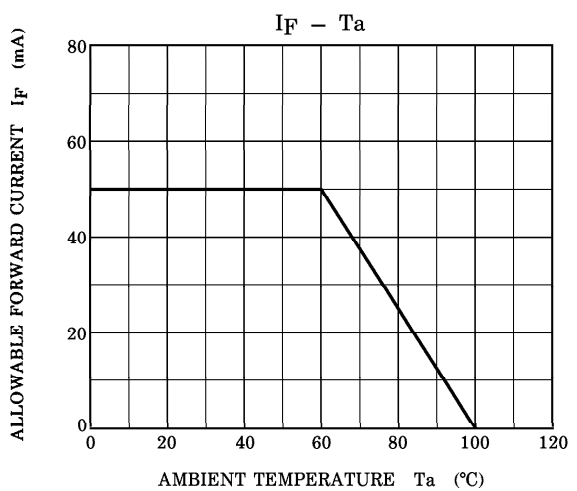
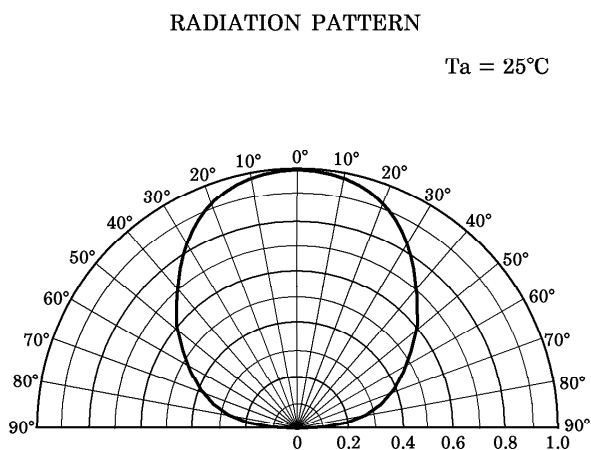
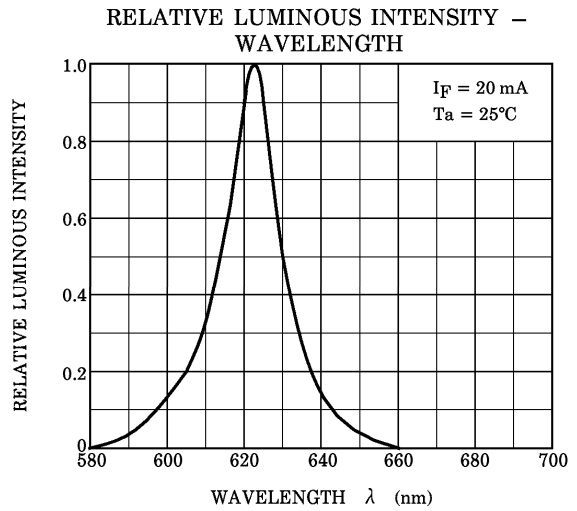
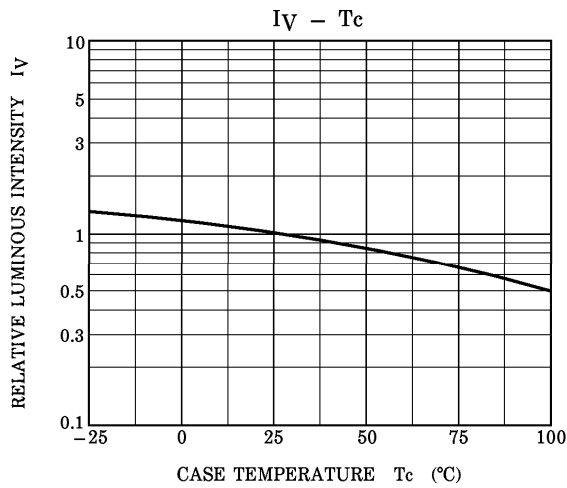
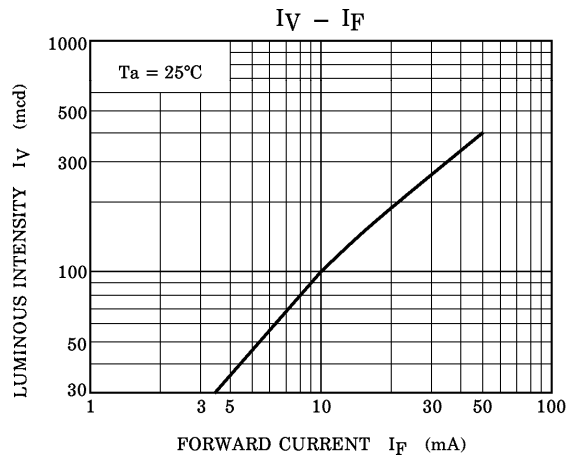
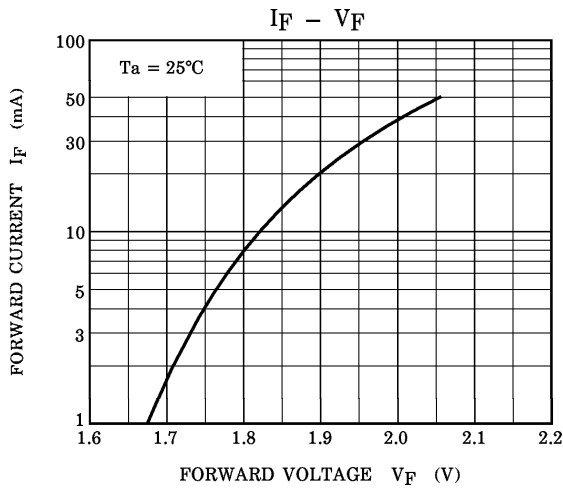

TLOE1100

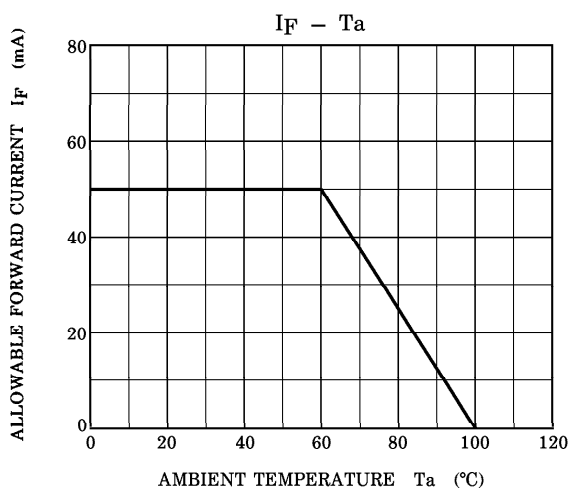
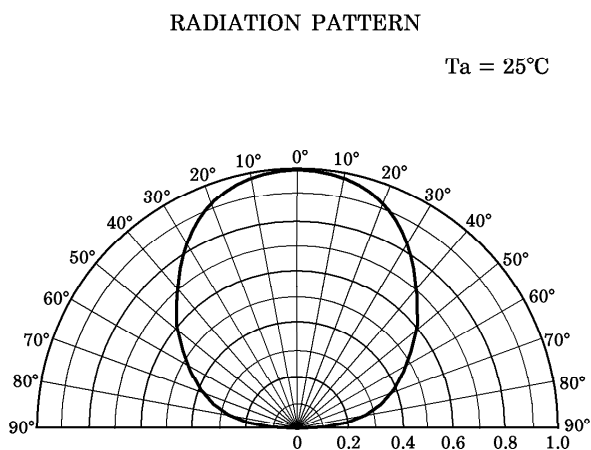
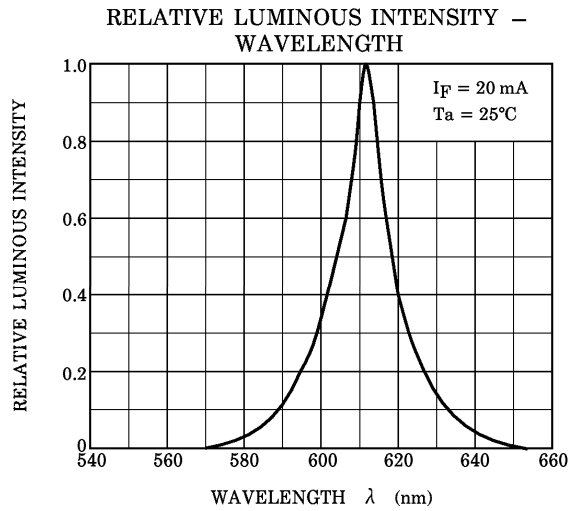
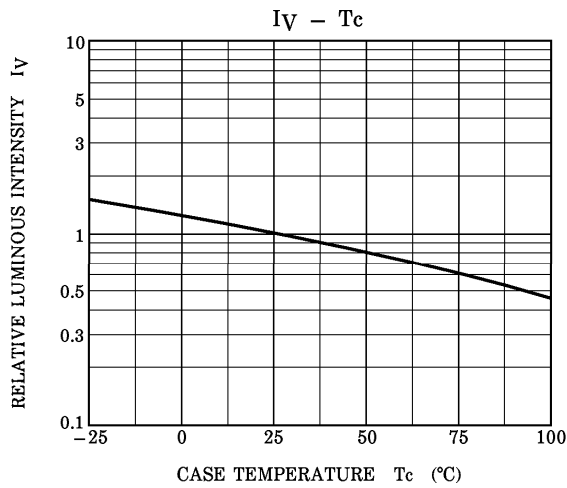
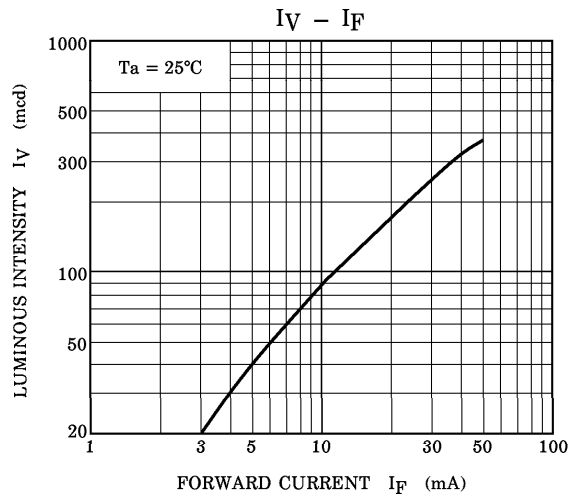
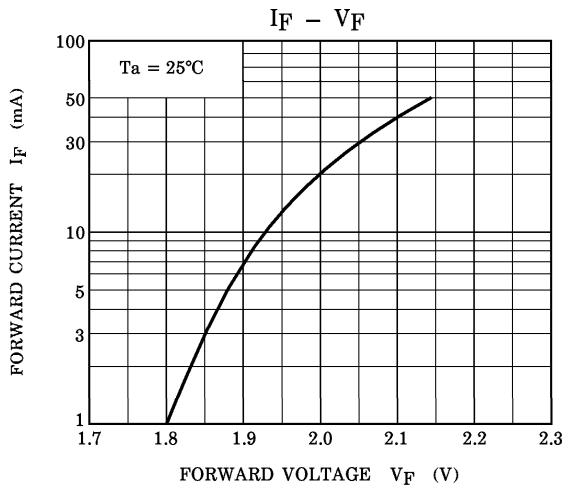

TLYE1100

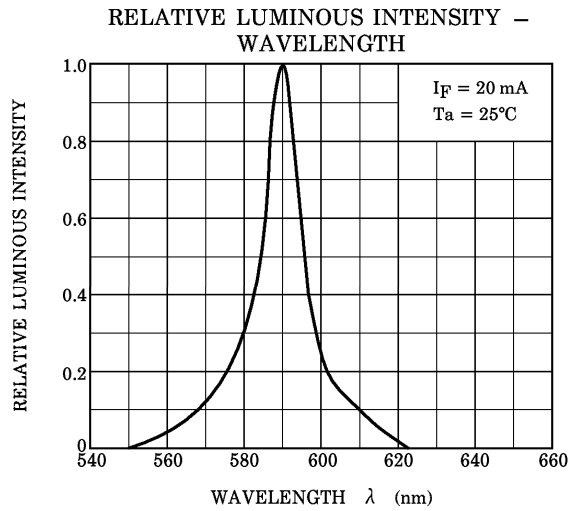
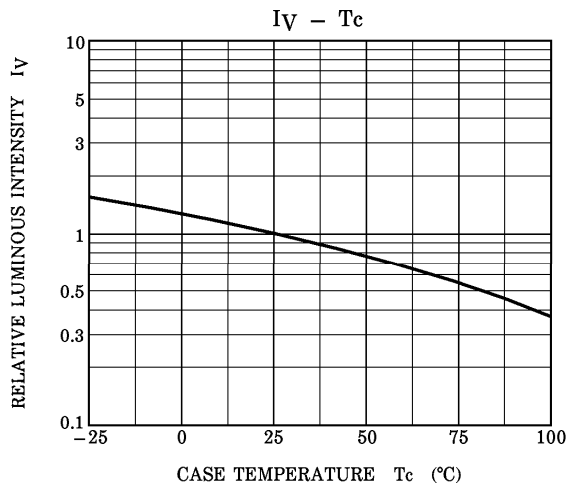
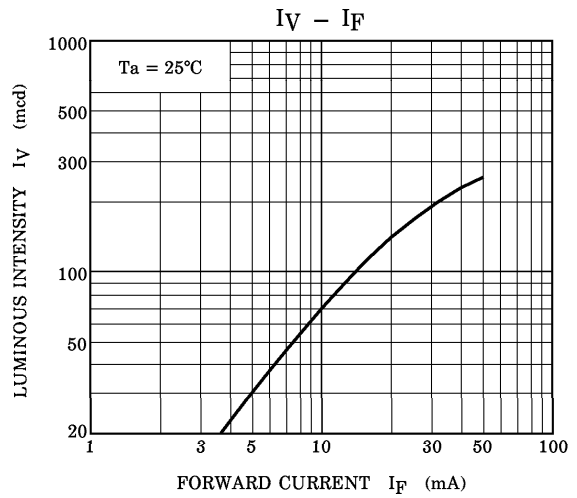
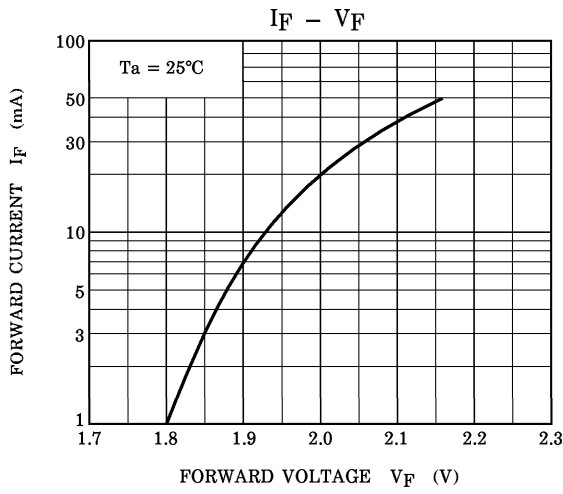

RADIATION PATTERN

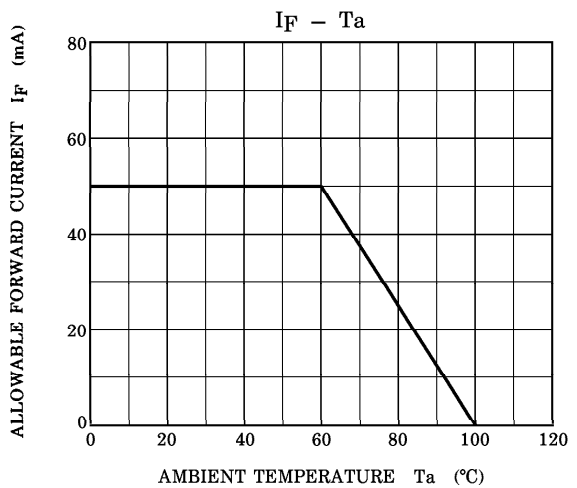
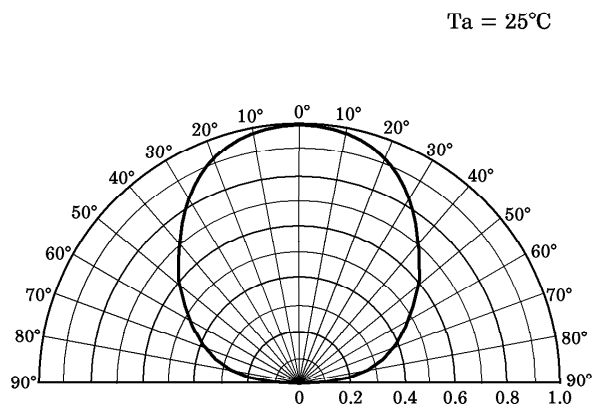

TLGE1100

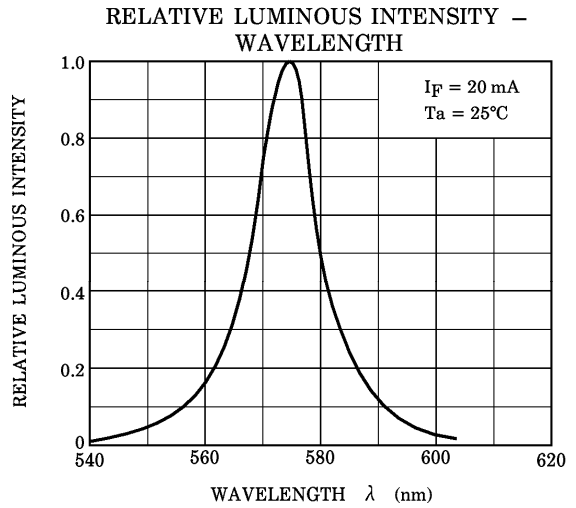
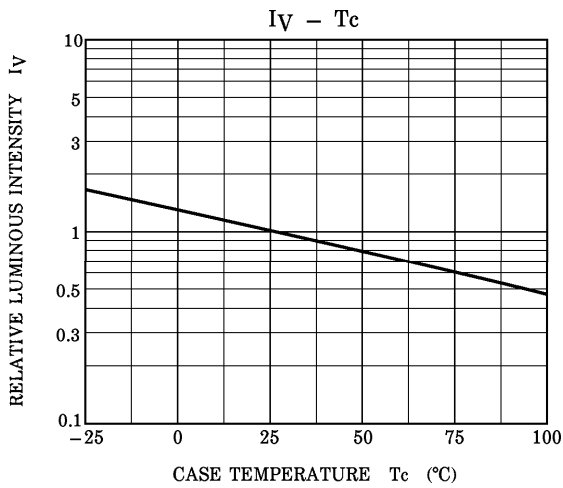
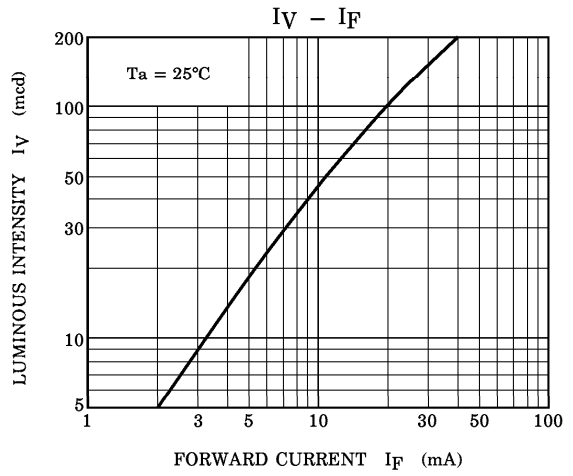
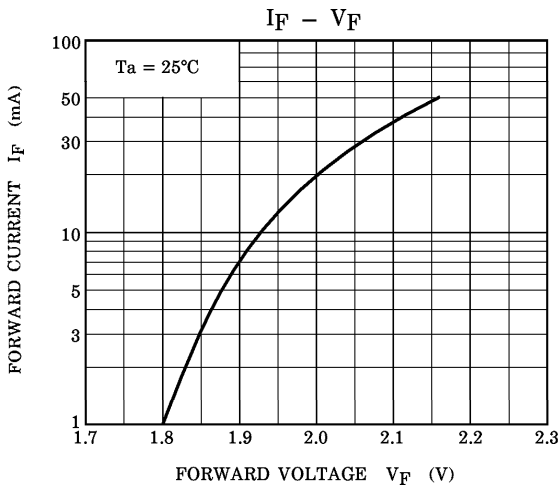

RADIATION PATTERN

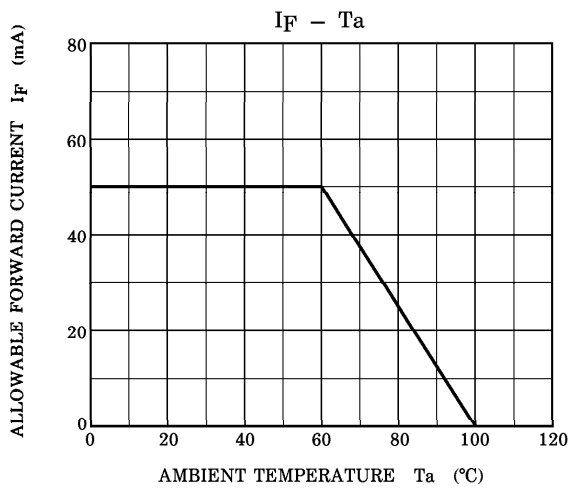
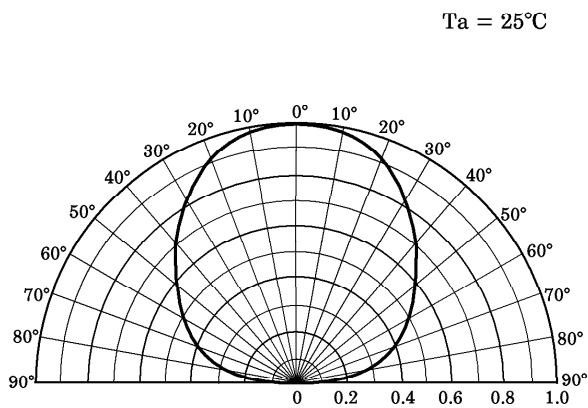

TLPGE1100

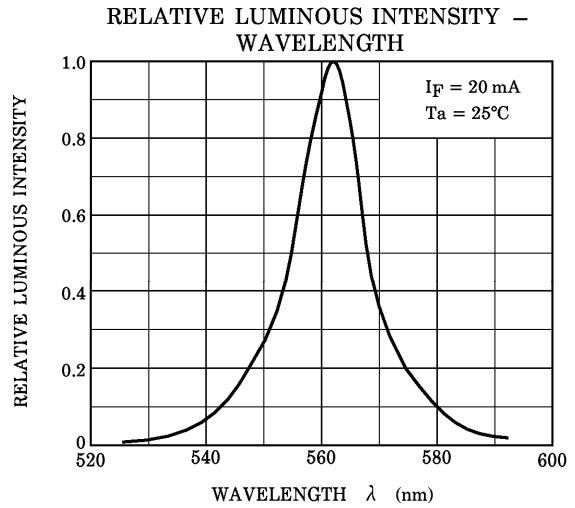
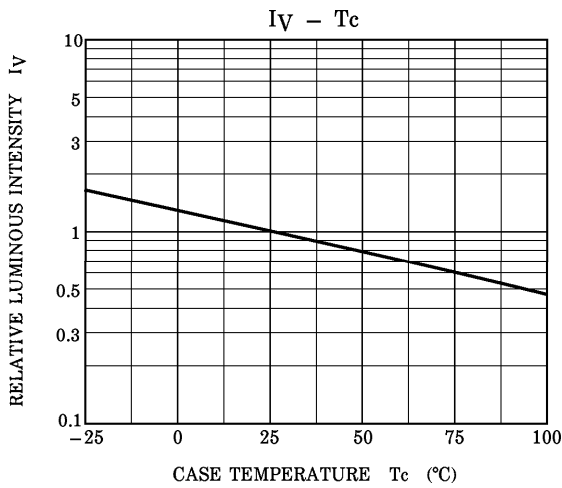
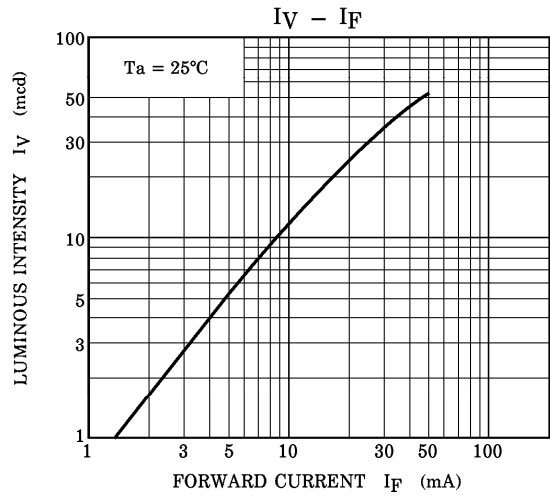
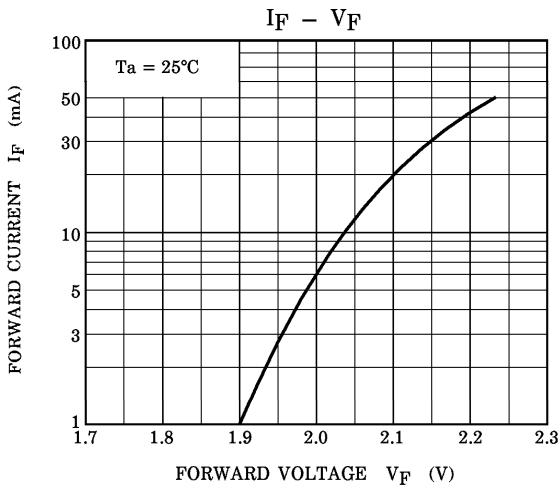

RADIATION PATTERN

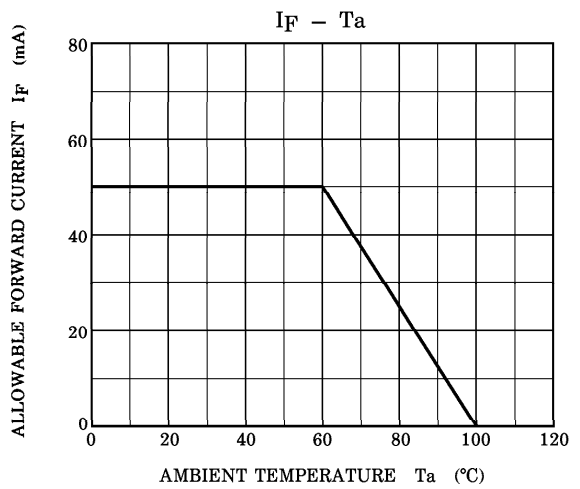
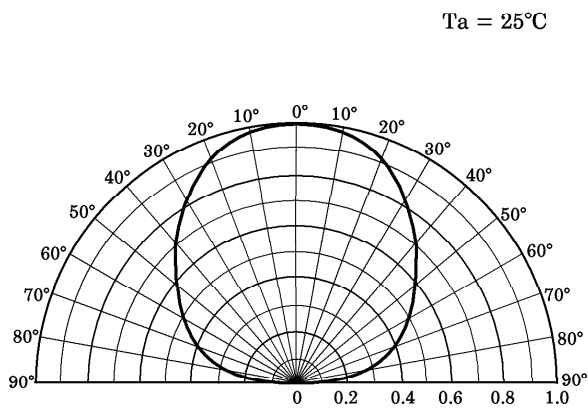

SOLDERING

Reflow soldering

Temperature profile

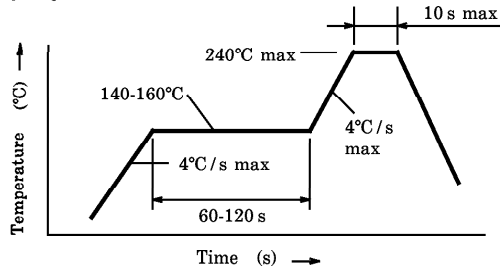

- Please perform the first reflow soldering within 168 h after opening the package with reference to the above temperature profile.
- Second time reflow soldering

In case of second reflow soldering, it should be performed within 168 h after first reflow under the above conditions.

Storage conditions before second reflow soldering : 30°C, 60% RH or lower

Recommended soldering pattern

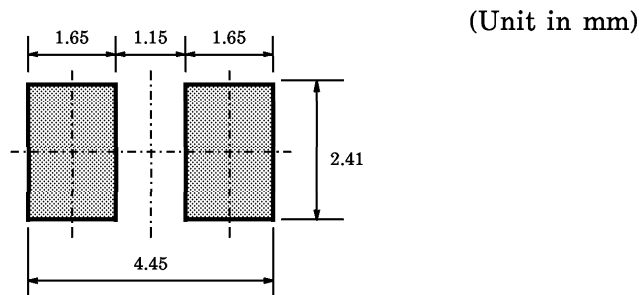

RECOMMENDATION FOR MANUAL SOLDERING

- Soldering iron : Less than 25 W
- Temperature : Lower than 300°C
- Time : Within 3 s

POST SOLDERING CLEANING

When cleaning after soldering is needed, the following condition must be adhered to.

- Cleaning solvents : AK225 or Alcohol
- Temperature : 50°C (max) for 30 s (max) or 30°C (max) for 3 minutes (max)
- Ultrasonic : 300 W max

PACKAGING

This LED device is packed in an aluminum envelope with silica-gel to avoid moisture absorption. The optical characteristics may be affected by exposure to moisture in the air before soldering and storage at the following condition is recommended.

Temperature : 5~30°C

Relative Humidity : 60% or lower

Baking is required if the device have been stored unopened for more than 6 month or if the aluminum envelope has been opened for more than 168 h.

Recommended baking condition is 60°C for 12 h minimum in the dry atmosphere.

PRECAUTION FOR MOUNTING

Do not apply force to the plastic part of the LED in high temperature conditions.

Do not apply friction using hard materials for avoid injuring the plastic part of the LED.

Keep the LED away from any other parts when assembling boards into the set.

TAPING SPECIFICATIONS

1. Taping Number

(1) Name : T11

(2) Example : TLSE1100 (T11)

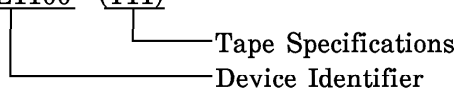

2. Dimension of tape

(Unit in mm)

ITEM	DIMENSIONS	TOLERANCE	ITEM	DIMENSIONS	TOLERANCE
D	1.5	+0.1/ -0	P ₂	2.0	±0.05
E	1.75	±0.1	W	8.0	±0.3
P ₀	4.0	±0.1	P	4.0	±0.1
t	0.3	±0.05	A ₀	2.9	±0.1
F	3.5	±0.05	B ₀	3.7	±0.1
D ₁	(1.5)	(±0.1)	K ₀	2.3	±0.1

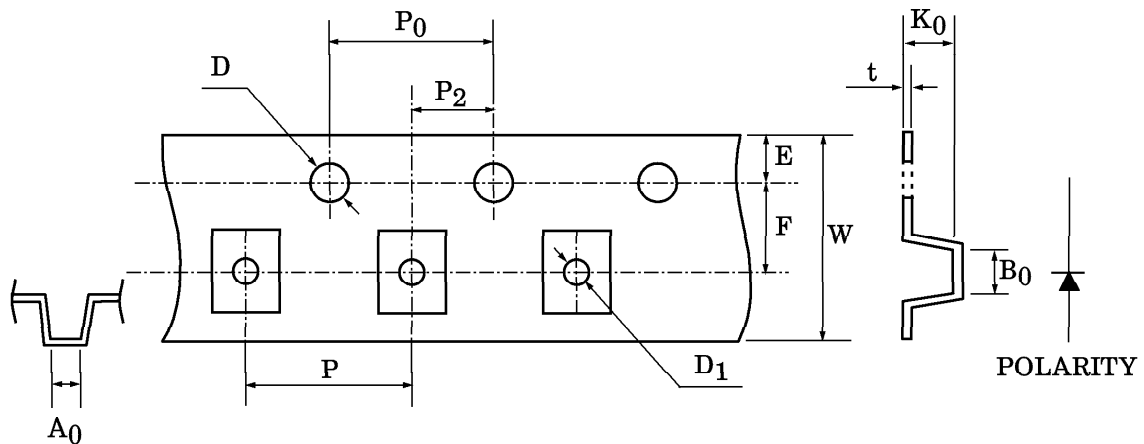

3. Dimension of reel

(Unit in mm)

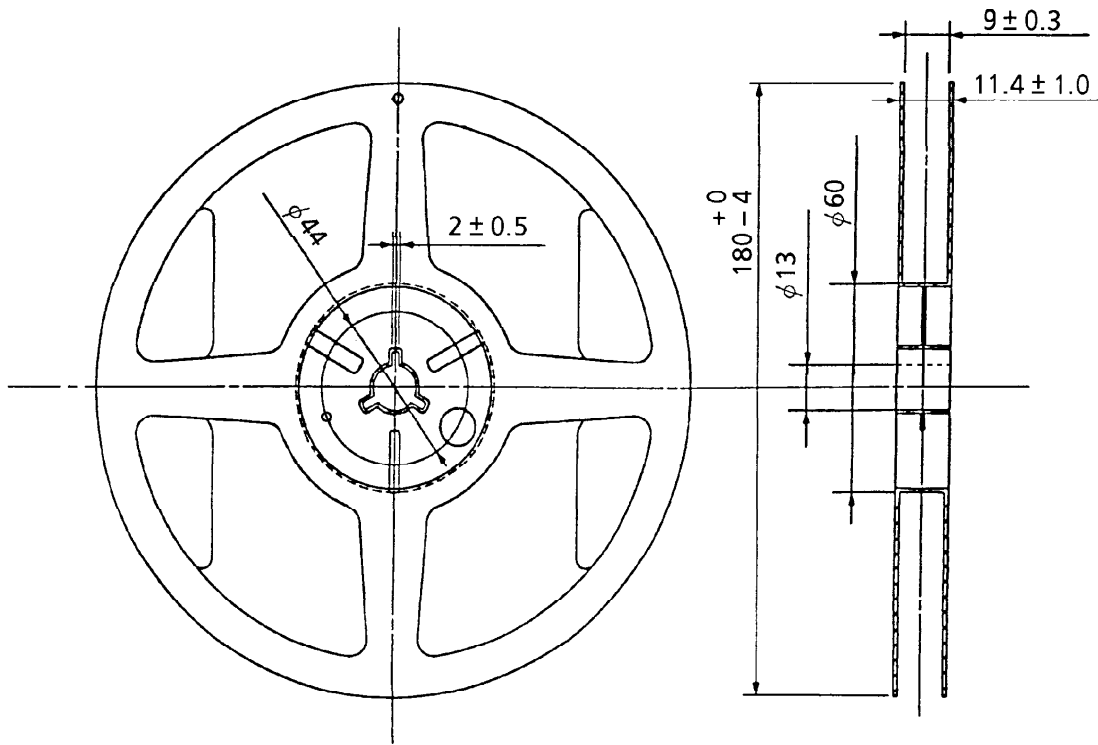

4. Leading part

(Unit in mm)

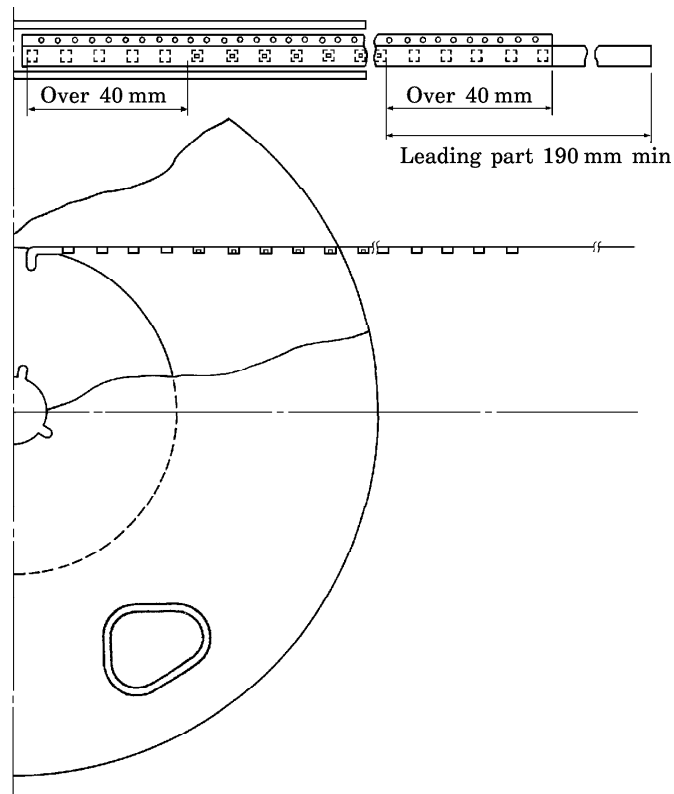

6. Packing Form

(1) Number of Devices per Reel and Carton

Reel	2000 devices
Carton	10000 devices

(2) Packing : Silica gel and reel are packed into sealed aluminum pack.

7. Notation Method

(1) Example : TLRE1100 (T11)

P/N :

TYPE	TLRE1100		
ADD. C	(T11)	Q'TY	2000 pcs
NOTE	(rank symbol)		Lot Number

(2) Label location :

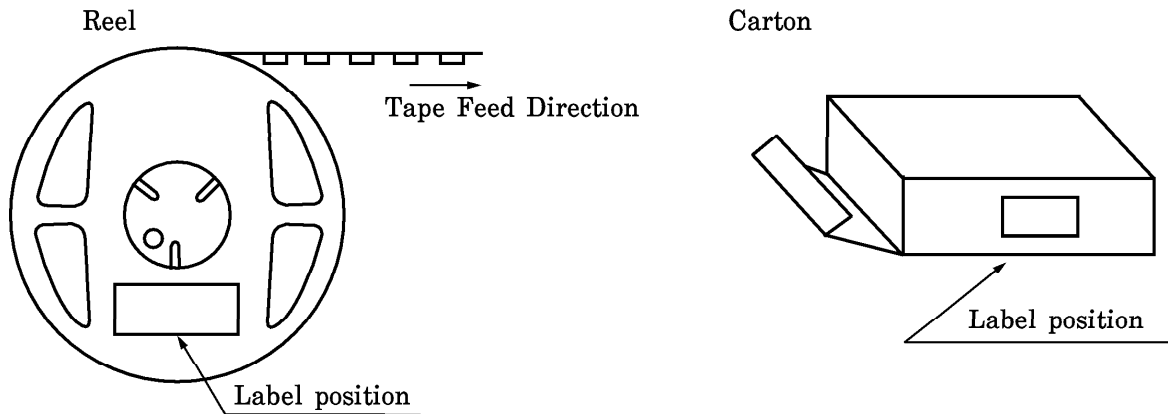

Aluminum pack : Attached to center of one side