

HPWT-TH00
HPWT-FH00
HPWT-TL00
HPWT-FL00

SnapLED 70

Technical Data DS09

Using Lumileds' patented solderless clinch technology, SnapLED 70 emitters are attached to a formable metal substrate that offers both styling flexibility and ruggedness unmatched by any other LED assembly.

SnapLED's brilliant luminance, flexibility, and reliability enable distinctive and durable lighting designs for vehicles, signals, and specialty lighting.

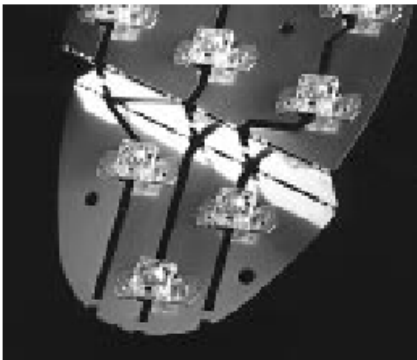

Benefits

- Rugged Lighting Products
- Electricity Savings
- Maintenance Savings
- 3-Dimensional Array Design
- Environmental Conformance

Features

- High Luminance
- Low Power Consumption
- Low Thermal Resistance
- Low Profile
- Solderless Mounting Technique
- Formable Substrate
- Meets SAE/ECE/JIS

Automotive

Color Requirements

- Packaged in tubes for use with automatic insertion equipment

Typical Applications

- Automotive Lighting
 - Rear Combination Lamps
 - Front Turn Signal Lamps
 - High Mount Stop Lamps
 - Indirect Lighting
- Solid State Lighting and Signaling

Outline Drawings

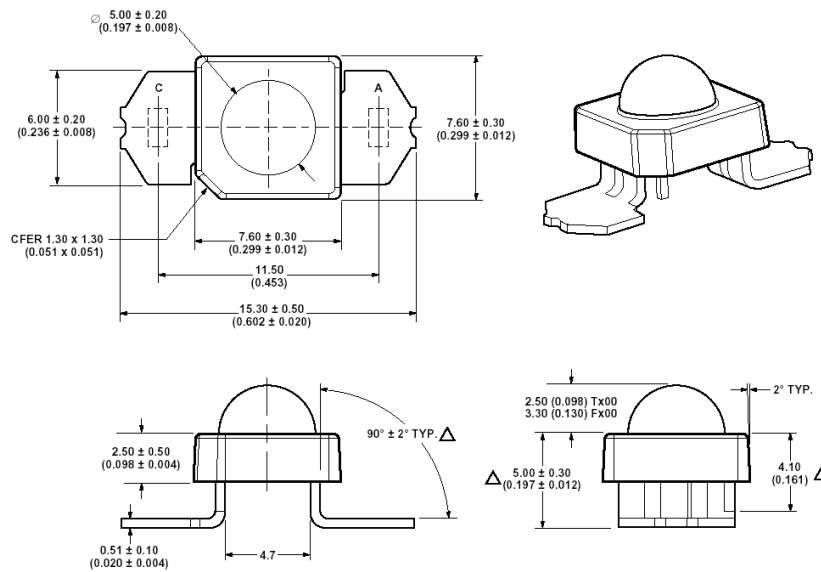

Notes:

1. Dimensions are in millimeters (inches).
2. Dimensions without tolerances are nominal.
3. Cathode lead is indicated with a "C" and anode lead is indicated with an "A."
4. Special characteristics are designated with a triangle.
5. Clinch joint locations shown in dashed lines on top view of part (11.50 mm spacing).

Selection Guide

PART NUMBER	LED COLOR	TOTAL FLUX Φ_V (LM) @ 70 mA ⁽¹⁾ MIN.	TOTAL INCLUDED ANGLE $\theta_{0.90V}$ (DEGREES) ⁽²⁾ TYP.
HPWT-TH00-00000	TS ALINGAP RED-ORANGE	3.0	120
HPWT-FH00-00000			70
HPWT-TL00-00000	TS ALINGAP AMBER	1.5	120
HPWT-FL00-00000			70

Notes:

1. Φ_V is the total luminous flux output as measured with an integrating sphere after the device has stabilized ($R_{\theta_{j-a}} = 200^\circ\text{C/W}$, $T_A = 25^\circ\text{C}$).
2. $\theta_{0.90V}$ is the included angle at which 90% of the total luminous flux is captured. See Figure 5.

Absolute Maximum Ratings at $T_A = 25^\circ\text{C}$

PARAMETER	HPWT-TX00/FX00	UNITS
DC FORWARD CURRENT ^(1,2)	70	mA
POWER DISSIPATION	221	mW
REVERSE VOLTAGE ($I_R = 100 \mu\text{A}$)	10	V
OPERATING TEMPERATURE RANGE	-40 TO +100	$^\circ\text{C}$
STORAGE TEMPERATURE RANGE	-55 TO +100	$^\circ\text{C}$
HIGH TEMPERATURE CHAMBER	125 (2 HRS.)	$^\circ\text{C}$
LED JUNCTION TEMPERATURE	125	$^\circ\text{C}$

Notes:

1. Operation at currents below 10 mA is not recommended.
2. Derate linearly as shown in Figure 3.

Optical Characteristics at $T_A = 25^\circ\text{C}$, $I_F = 70\text{ mA}$, $R_{\theta\text{J-A}} = 200^\circ\text{C/W}$

DEVICE TYPE	TOTAL FLUX	PEAK WAVELENGTH	COLOR, DOMINANT WAVELENGTH	TOTAL INCLUDED ANGLE $\theta_{0.90V}$	RATIO OF LUMINOUS INTENSITY TO TOTAL FLUX	VIEWING ANGLE
	Φ_V (LM) ⁽¹⁾ MIN.	λ_{PEAK} (NM) TYP.	λ_D (NM) ⁽²⁾ TYP.	(DEGREES) ⁽³⁾ TYP.	$I_V(\text{CD})/\Phi_V(\text{LM})$ TYP.	2θ 1/2 (DEGREES) TYP.
HPWT-THOO HPWT-FHOO	3.0	630	621	120 70	0.6 2.0	85 30
HPWT-TLOO HPWT-FLOO	1.5	596	594	120 70	0.6 2.0	85 30

Notes:

- Φ_V is the total luminous flux output as measured with an integrating sphere after the device has stabilized.
- The dominant wavelength is derived from the CIE Chromaticity Diagram and represents the perceived color of the device.
- $\theta_{0.90V}$ is the included angle at which 90% of the total luminous flux is captured. See Figure 5.

Electrical Characteristics at $T_A = 25^\circ\text{C}$

DEVICE TYPE	FORWARD VOLTAGE V_F (VOLTS) @ $I_F = 70\text{ MA}$			REVERSE BREAKDOWN V_R (VOLTS) @ $I_R = 100\ \mu\text{A}$		CAPACITANCE C (PF) $V_F = 0$, F = 1 MHz.	THERMAL RESISTANCE $R_{\theta\text{J-PIN}}$ ($^\circ\text{C/W}$)	SPEED OF RESPONSE τ_s (NS) ⁽¹⁾
	MIN.	TYP.	MAX.	MIN.	TYP.	TYP.	TYP.	TYP.
HPWT-xHOO	2.19	2.50	3.03	10	20	40	80	20
HPWT-xLOO	2.19	2.60	3.15	10	20	40	100	20

Figures

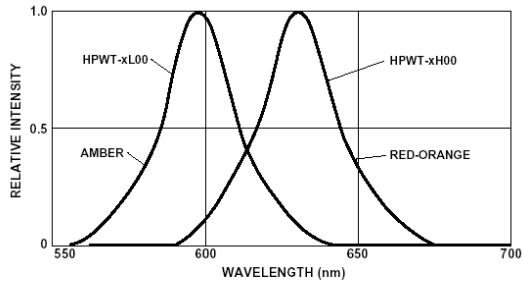

Figure 1. Relative Intensity vs. Wavelength.

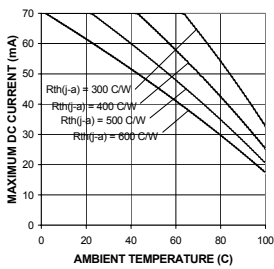
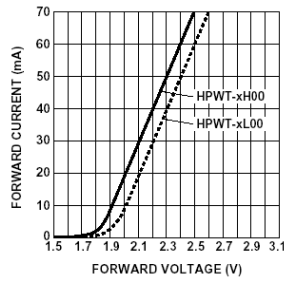

Figure 3. HPWT-xx00 Maximum DC Forward Current vs. Ambient Temperature.

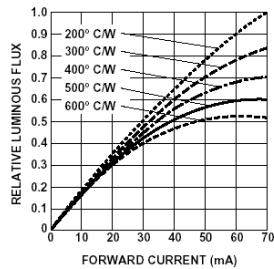

Figure 4. HPWT-xx00 Relative Luminous Flux vs. Forward Current.

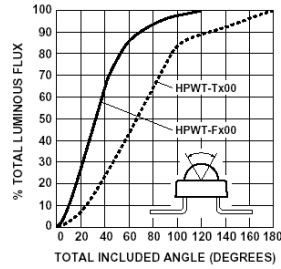

Figure 5. HPWT-xx00 Percent Total Luminous Flux vs. Total Included Angle.

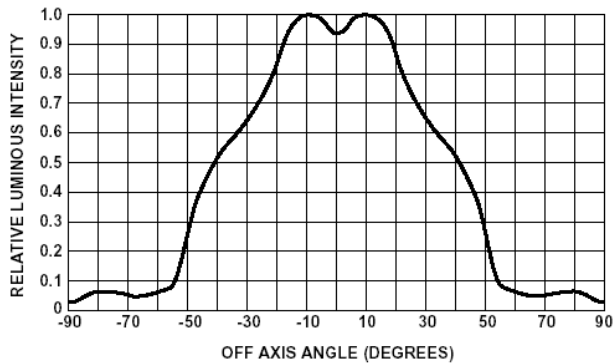

Figure 6a. HPWT-Tx00 Relative Intensity vs. Off Axis Angle.

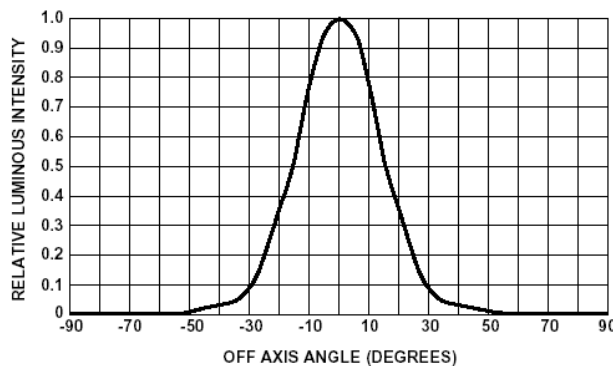

Figure 6b. HPWT-Fx00 Relative Intensity vs. Off Axis Angle.

Note:
For additional information,
please refer to the Lumileds
AN 1149 Series.

Company Information

SnapLED™ is developed, manufactured and marketed by Lumileds Lighting, LLC. Lumileds is a world-class supplier of Light Emitting Diodes (LEDs) producing billions of LEDs annually. Lumileds is a fully integrated supplier, producing core LED material in all three base colors (Red, Green, Blue) and White. Lumileds has R&D development centers in San Jose, California and Best, The Netherlands and production capabilities in San Jose, California and Malaysia.

Lumileds is pioneering high-flux LED technology and bridging the gap between solid state LED technology and the lighting world. Lumileds is absolutely dedicated to bringing the best and brightest LED technology to enable new applications and markets in the lighting world.

LUMILEDS™
LIGHT FROM SILICON VALLEY

©2004 Lumileds Lighting. All rights reserved. Lumileds Lighting is a joint venture between Agilent Technologies and Philips Lighting. Luxeon is registered a trademark of Lumileds Lighting, Inc. Product specifications are subject to change without notice.

Lumileds may make process or materials changes affecting the performance or other characteristics of our products. These products supplied after such changes will continue to meet published specifications, but may not be identical to products supplied as samples or under prior orders.

LUMILEDS

www.luxeon.com
www.lumileds.com

For technical assistance or the location of your nearest Lumileds sales office, call:

Worldwide:
+1 408-435-6044
US Toll free: 877-298-9455
Europe: +31 499 339 439
Fax: 408-435-6855
Email us at info@lumileds.com

Lumileds Lighting, LLC
370 West Trimble Road
San Jose, CA 95131