

Reflecting low-dome LEDs ($\phi 5.0$ mm)

SLR-56 Series

The SLR-56 series are small $\phi 5$ mm LEDs with a high luminous efficiency. Four colors and two lens types are available for a total of eight different types, and they are suitable for use in a wide variety of applications.

●Features

- 1) High luminosity (with reflector).
- 2) Four colors : red, orange, yellow and green.
- 3) Two lens types : Colored diffused and Colored clear.
- 4) Low-dome type with a diameter of 5 mm.
- 5) High reliability.

●Selection guide

Emitting color Lens	Red	Orange	Yellow	Green
	Colored diffused	SLR-56VR	SLR-56DU	SLR-56YY
Colored clear	SLR-56VC	SLR-56DC	SLR-56YC	SLR-56MC

●Absolute maximum ratings ($T_a = 25^\circ\text{C}$)

Parameter	Symbol	Red	Orange	Yellow	Green	Unit
		SLR-56VR SLR-56VC	SLR-56DU SLR-56DC	SLR-56YY SLR-56YC	SLR-56MG SLR-56MC	
Power dissipation	P_D	60	60	60	75	mW
Forward current	I_F	20	20	20	25	mA
Peak forward current	I_{FP}	60*	60*	60*	60*	mA
Reverse voltage	V_R	3	3	3	3	V
Operating temperature	T_{opr}	-25~+85				$^\circ\text{C}$
Storage temperature	T_{stg}	-30~+100				$^\circ\text{C}$
Soldering temperature	—	260 $^\circ\text{C}$ 5 seconds maximum				—

* Pulse width 1ms Duty 1 / 5

●External dimensions (Units: mm)

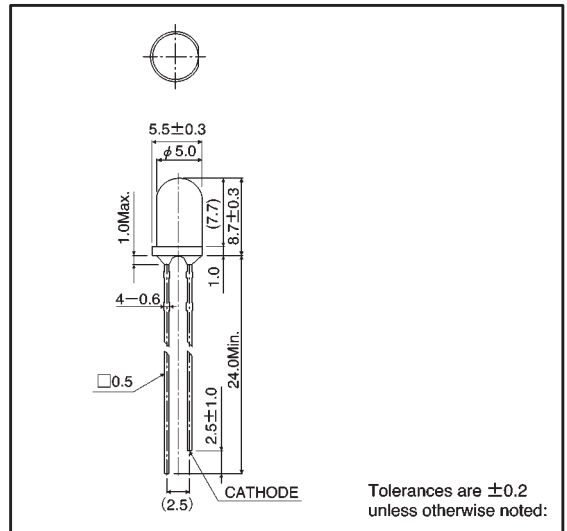

●Electrical and optical characteristics (Ta = 25°C)

Parameter	Symbol	Conditions	Red			Orange			Yellow			Green			Unit
			Min.	Typ.	Max.	Min.	Typ.	Max.	Min.	Typ.	Max.	Min.	Typ.	Max.	
Forward voltage	V_F	$I_F=10\text{mA}$	—	2.0	3.0	—	2.0	3.0	—	2.1	3.0	—	2.1	3.0	V
Reverse current	I_R	$V_R=3\text{V}$	—	—	10	—	—	10	—	—	10	—	—	10	μA
Peak wavelength	λ_P	$I_F=10\text{mA}$	—	650	—	—	610	—	—	585	—	—	563	—	nm
Spectral line half width	$\Delta \lambda$	$I_F=10\text{mA}$	—	40	—	—	40	—	—	40	—	—	40	—	nm
Viewing angle	$2\theta_{1/2}$	Diffused	—	40	—	—	40	—	—	40	—	—	40	—	deg
		Transparent	—	35	—	—	35	—	—	35	—	—	35	—	

●Luminous intensity vs. wavelength

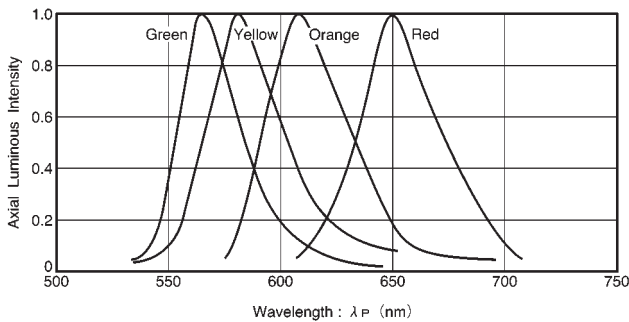

Fig. 1

●Luminous intensity

Color	λ_P	Type	Min.	Typ.	Max.	Unit
Red	650	SLR-56VR	3.6	10	—	mcd
		SLR-56VC	9.0	25	—	mcd
Orange	610	SLR-56DU	3.6	10	—	mcd
		SLR-56DC	9.0	25	—	mcd
Yellow	585	SLR-56YY	3.6	10	—	mcd
		SLR-56YC	9.0	25	—	mcd
Green	563	SLR-56MG	5.6	16	—	mcd
		SLR-56MC	14	40	—	mcd

Note: Measured at $I_F = 10 \text{ mA}$

●Directional pattern

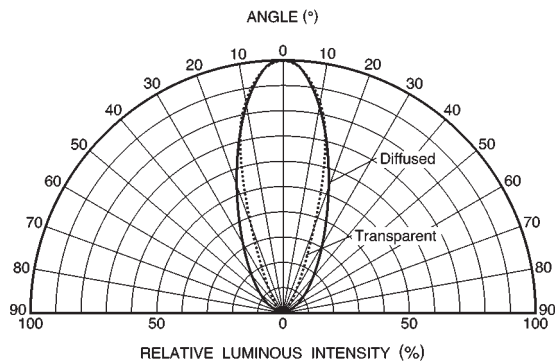

Fig. 2

●Electrical characteristic curves 1 (red)

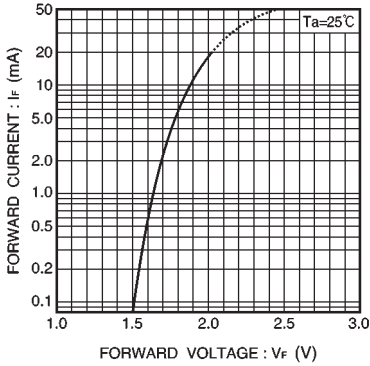

Fig. 3 Forward current vs. forward voltage

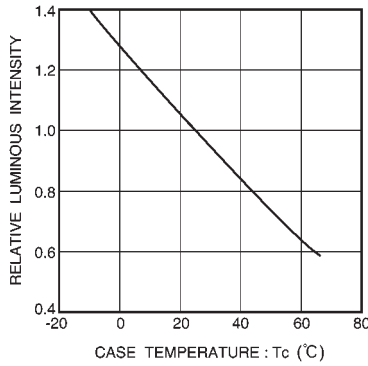

Fig. 4 Luminous intensity vs. case temperature

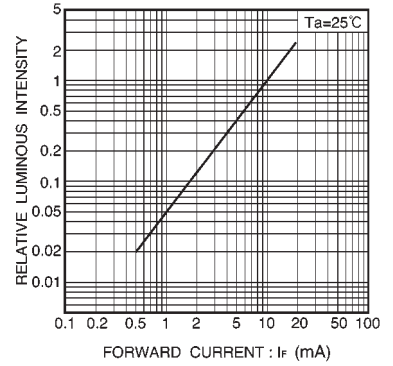

Fig. 5 Luminous intensity vs. forward current

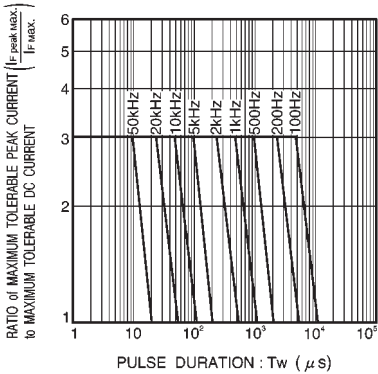

Fig. 6 Maximum tolerable peak current vs. pulse duration

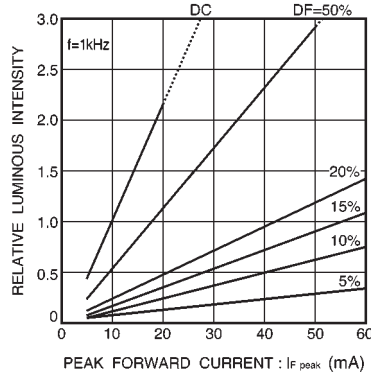

Fig. 7 Luminous intensity vs. peak forward current

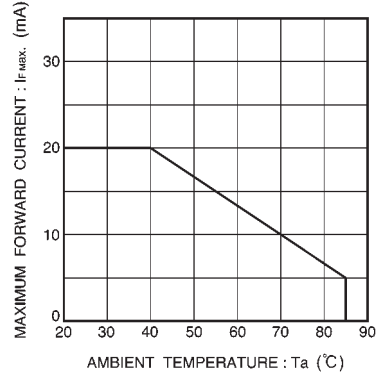

Fig. 8 Maximum forward current vs. ambient temperature

●Electrical characteristic curves 2 (orange)

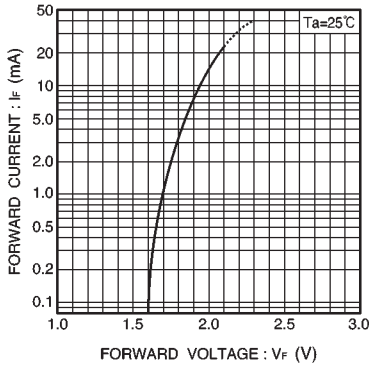

Fig. 9 Forward current vs. forward voltage

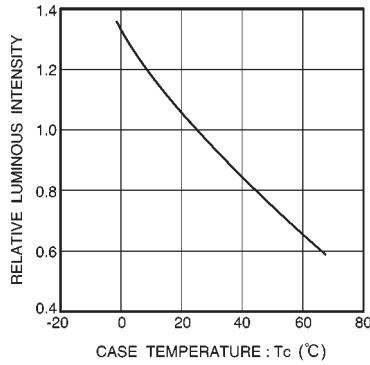

Fig. 10 Luminous intensity vs. case temperature

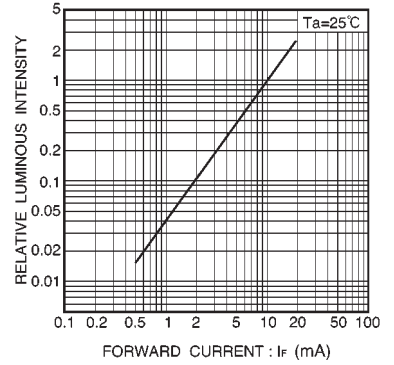

Fig. 11 Luminous intensity vs. forward current

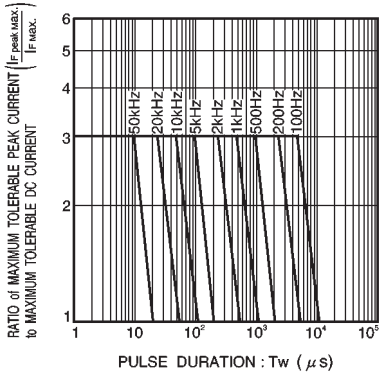

Fig. 12 Maximum tolerable peak current vs. pulse duration

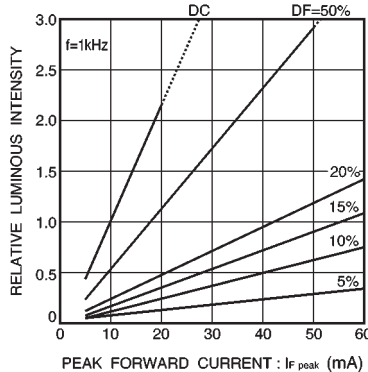

Fig. 13 Luminous intensity vs. peak forward current

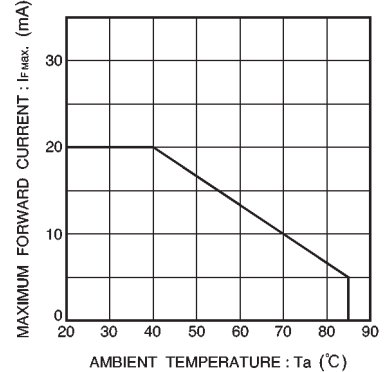

Fig. 14 Maximum forward current vs. ambient temperature

●Electrical characteristic curves 3 (yellow)

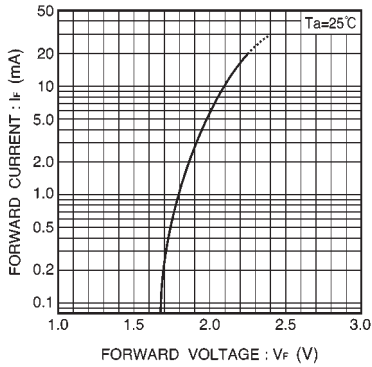

Fig. 15 Forward current vs. forward voltage

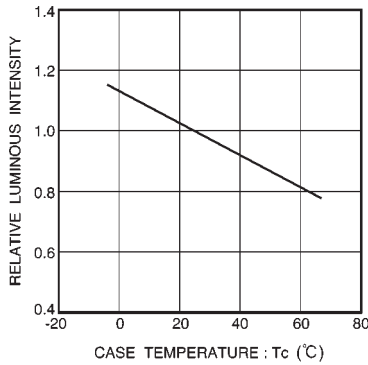

Fig. 16 Luminous intensity vs. case temperature

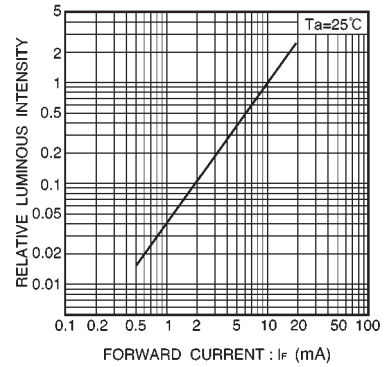

Fig. 17 Luminous intensity vs. forward current

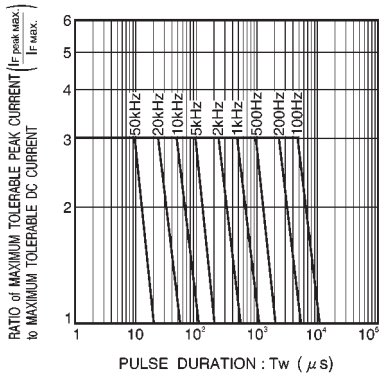

Fig. 18 Maximum tolerable peak current vs. pulse duration

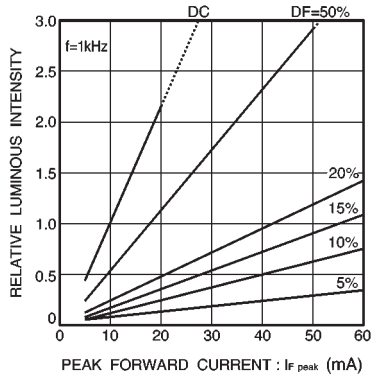

Fig. 19 Luminous intensity vs. peak forward current

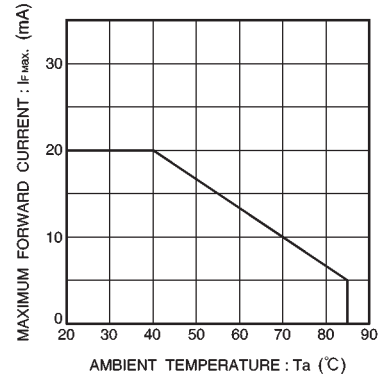

Fig. 20 Maximum forward current vs. ambient temperature

●Electrical characteristic curves 4 (green)

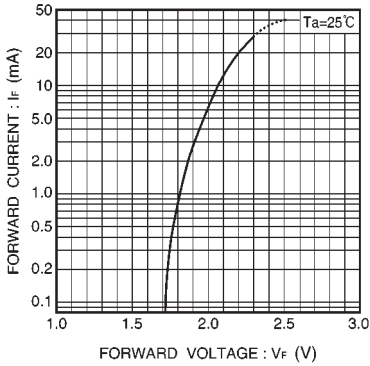

Fig. 21 Forward current vs. forward voltage

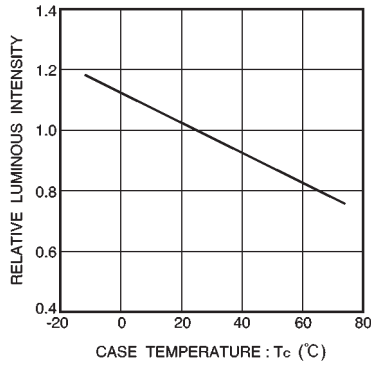

Fig. 22 Luminous intensity vs. case temperature

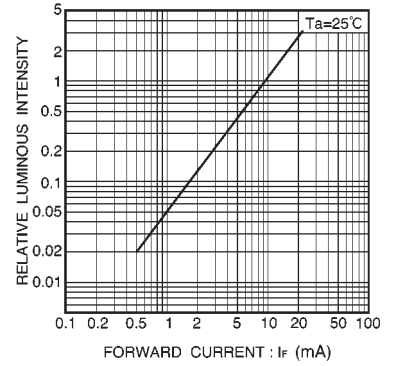

Fig. 23 Luminous intensity vs. forward current

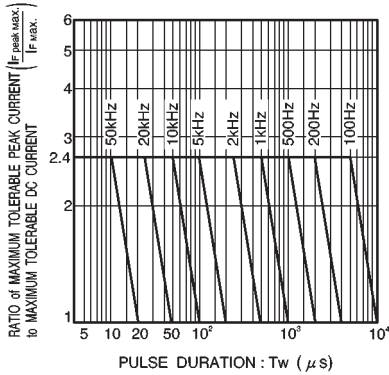

Fig. 24 Maximum tolerable peak current vs. pulse duration

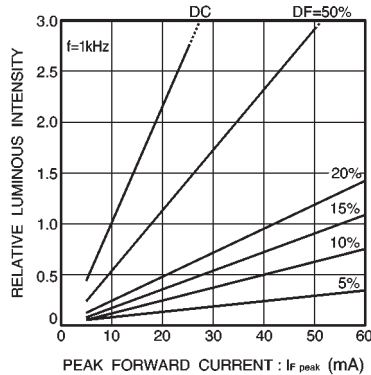

Fig. 25 Luminous intensity vs. peak forward current

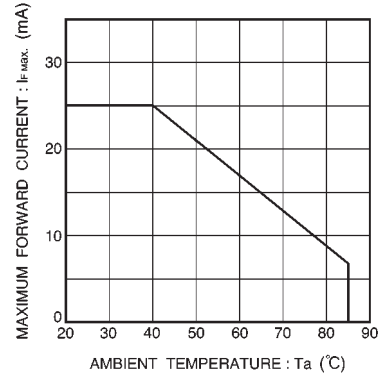

Fig. 26 Maximum forward current vs. ambient temperature