

Reflecting small LEDs, directly mountable ($\phi 3.1 \text{ mm} \times 2 \text{ mm}$)

SLR-322 Series

The SLR-322 series are small $3.1 \text{ mm} \times 2 \text{ mm}$ LEDs which can be directly mounted on a printed circuit board. Four colors and two lens types are available for a total of eight types, and they are suitable for use in a wide variety of applications.

●Features

- 1) Can be directly mounted on a printed circuit board with an automatic insertion machine.
- 2) Four colors : red, orange, yellow and green.
- 3) Two lens types : Colored diffused and Colored clear.
- 4) Compact $3.1 \text{ mm} \times 2 \text{ mm}$ epoxy resin package.
- 5) High reliability.

●Selection guide

Emitting color Lens	Red	Orange	Yellow	Green
	Colored diffused	SLR-322VR	SLR-322DU	SLR-322YY
Colored clear	SLR-322VC	SLR-322DC	SLR-322YC	SLR-322MC

●Absolute maximum ratings ($T_a = 25^\circ\text{C}$)

Parameter	Symbol	Red	Orange	Yellow	Green	Unit
		SLR-322VR SLR-322VC	SLR-322DU SLR-322DC	SLR-322YY SLR-322YC	SLR-322MG SLR-322MC	
Power dissipation	P_D	60	60	60	75	mW
Forward current	I_F	20	20	20	25	mA
Peak forward current	I_{FP}	60*	60*	60*	60*	mA
Reverse voltage	V_R	3	3	3	3	V
Operating temperature	T_{opr}	-25~+85				$^\circ\text{C}$
Storage temperature	T_{stg}	-30~+100				$^\circ\text{C}$
Soldering temperature	—	260 $^\circ\text{C}$ 5 seconds maximum				—

* Pulse width 1ms Duty 1 / 5

●External dimensions (Units: mm)

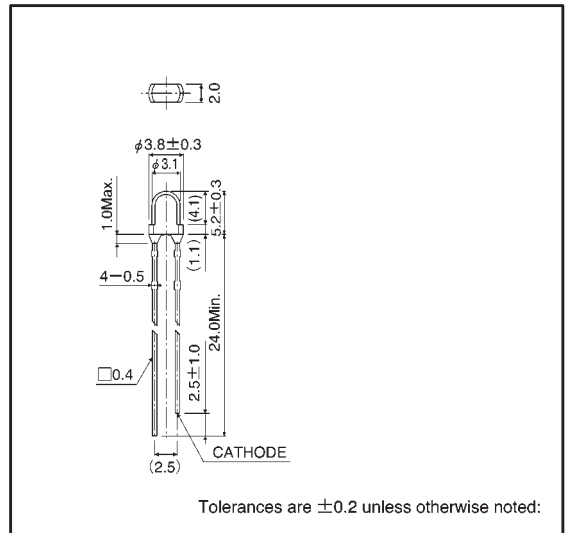

●Electrical and optical characteristics (Ta = 25°C)

Parameter	Symbol	Conditions	Red			Orange			Yellow			Green			Unit
			Min.	Typ.	Max.	Min.	Typ.	Max.	Min.	Typ.	Max.	Min.	Typ.	Max.	
Forward voltage	V_F	$I_F=10\text{mA}$	—	2.0	3.0	—	2.0	3.0	—	2.1	3.0	—	2.1	3.0	V
Reverse current	I_R	$V_R=3\text{V}$	—	—	10	—	—	10	—	—	10	—	—	10	μA
Peak wavelength	λ_P	$I_F=10\text{mA}$	—	650	—	—	610	—	—	585	—	—	563	—	nm
Spectral line half width	$\Delta \lambda$	$I_F=10\text{mA}$	—	40	—	—	40	—	—	40	—	—	40	—	nm
Viewing angle	$2\theta_{1/2}$	Transparent	—	35	—	—	35	—	—	35	—	—	35	—	deg
		Diffused	—	55	—	—	55	—	—	55	—	—	55	—	

●Luminous intensity vs. wavelength

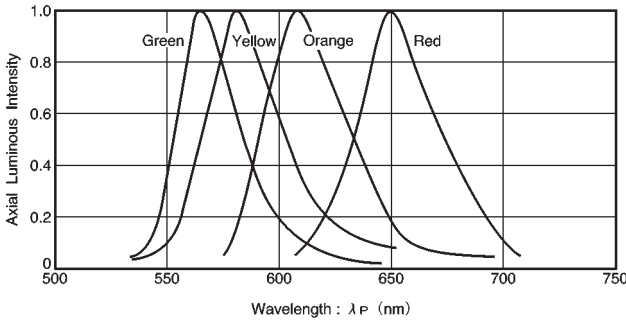

Fig. 1

●Luminous intensity

Color	λ_P	Type	Min.	Typ.	Max.	Unit
Red	650	SLR-322VR	3.6	10	—	mcd
		SLR-322VC	5.6	16	—	mcd
Orange	610	SLR-322DU	2.2	6.3	—	mcd
		SLR-322DC	5.6	16	—	mcd
Yellow	585	SLR-322YY	3.6	10	—	mcd
		SLR-322YC	3.6	10	—	mcd
Green	563	SLR-322MG	3.6	10	—	mcd
		SLR-322MC	9.0	25	—	mcd

Note: Measured at $I_F = 10\text{ mA}$

●Directional pattern

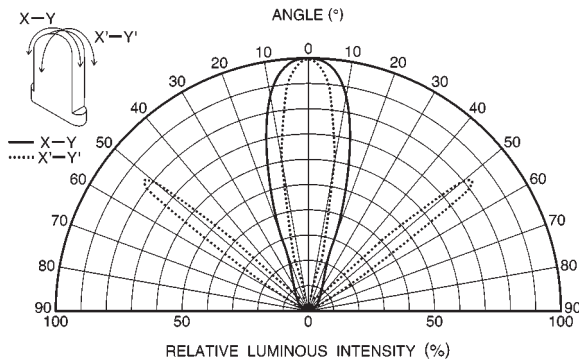

Fig. 2 Transparent type

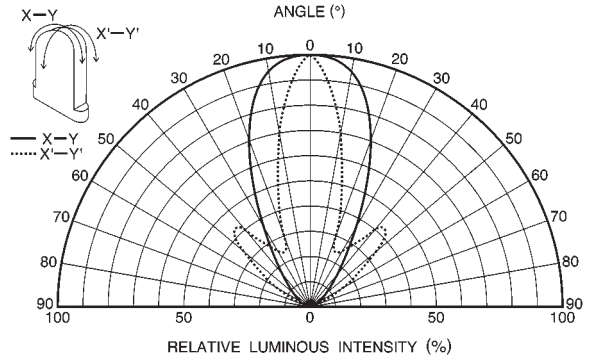

Fig. 3 Diffuse type

● Electrical characteristic curves 1 (red)

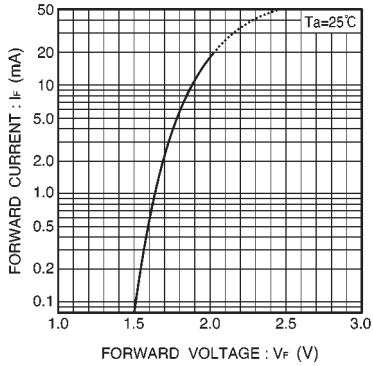

Fig. 4 Forward current vs. forward voltage

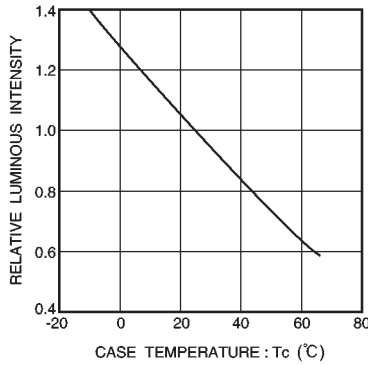

Fig. 5 Luminous intensity vs. case temperature

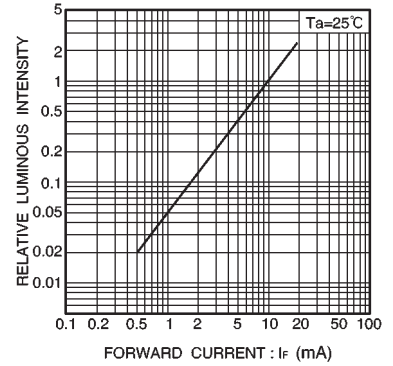

Fig. 6 Luminous intensity vs. forward current

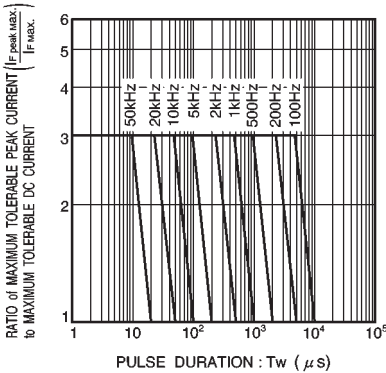

Fig. 7 Maximum tolerable peak current vs. pulse duration

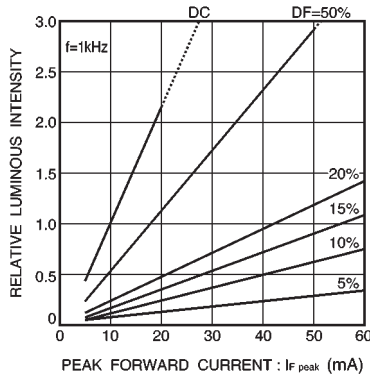

Fig. 8 Luminous intensity vs. peak forward current

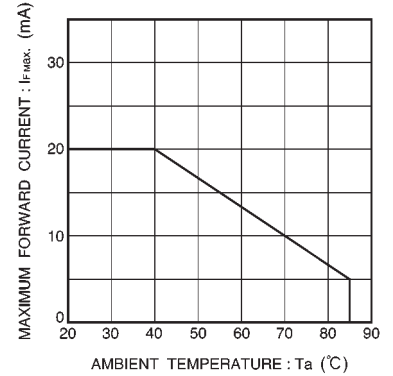

Fig. 9 Maximum forward current vs. ambient temperature

●Electrical characteristic curves 2 (orange)

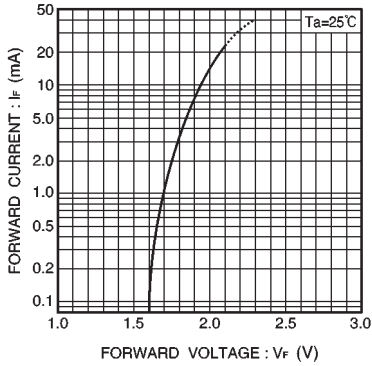

Fig. 10 Forward current vs. forward voltage

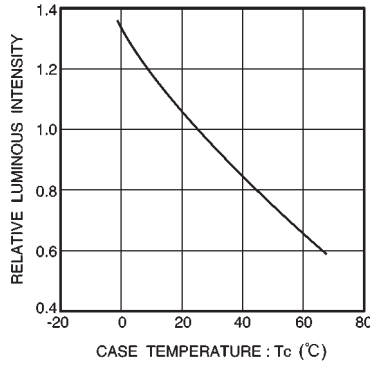

Fig. 11 Luminous intensity vs. case temperature

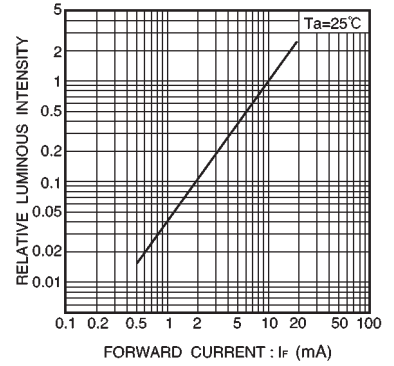

Fig. 12 Luminous intensity vs. forward current

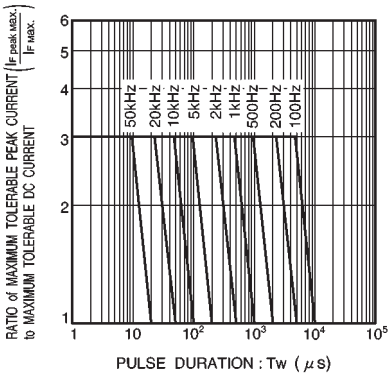

Fig. 13 Maximum tolerable peak current vs. pulse duration

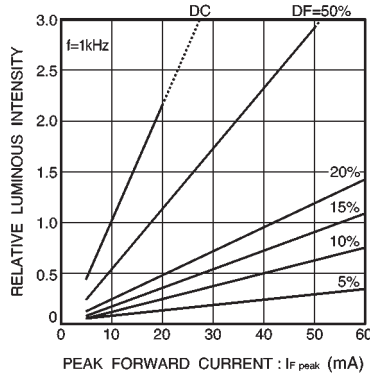

Fig. 14 Luminous intensity vs. peak forward current

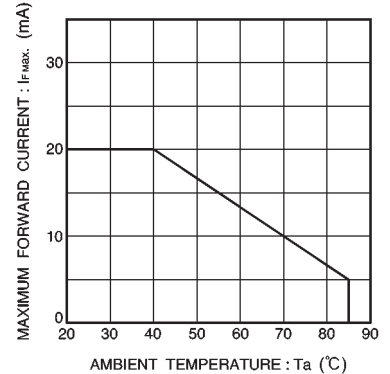

Fig. 15 Maximum forward current vs. ambient temperature

● Electrical characteristic curves 3 (yellow)

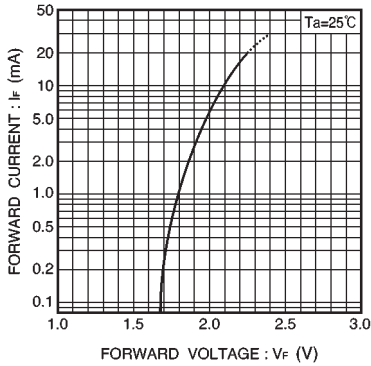

Fig. 16 Forward current vs. forward voltage

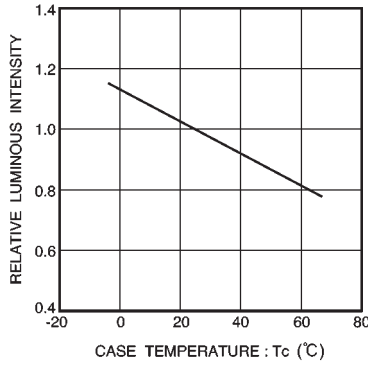

Fig. 17 Luminous intensity vs. case temperature

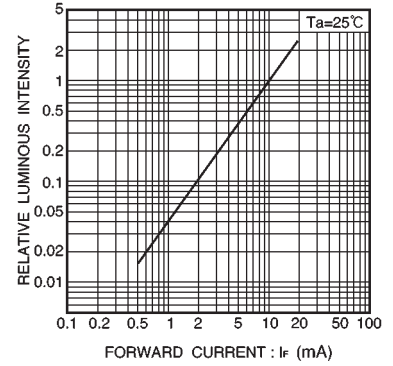

Fig. 18 Luminous intensity vs. forward current

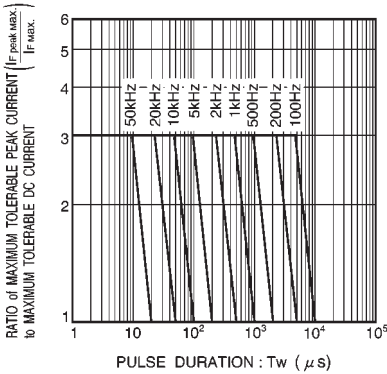

Fig. 19 Maximum tolerable peak current vs. pulse duration

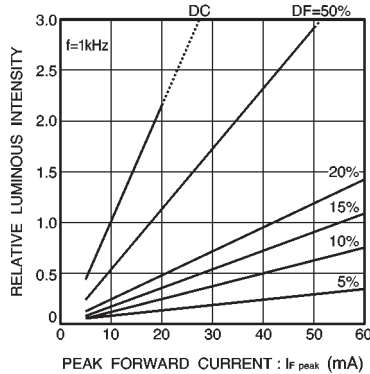

Fig. 20 Luminous intensity vs. peak forward current

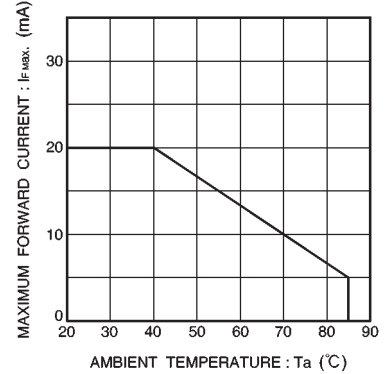

Fig. 21 Maximum forward current vs. ambient temperature

●Electrical characteristic curves 4 (green)

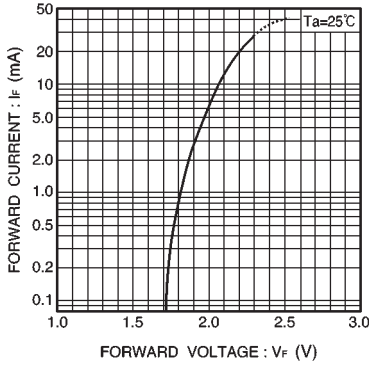

Fig. 22 Forward current vs. forward voltage

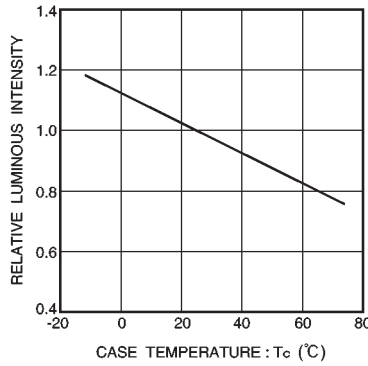

Fig. 23 Luminous intensity vs. case temperature

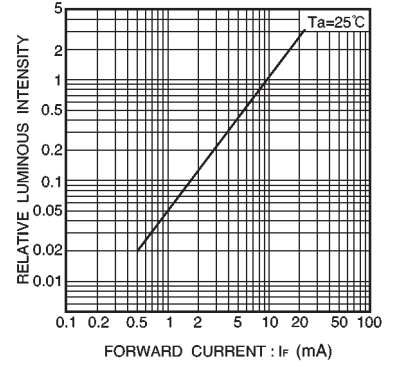

Fig. 24 Luminous intensity vs. forward current

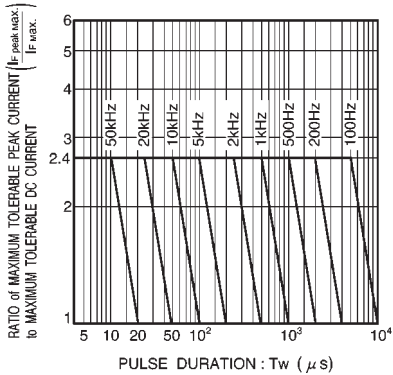

Fig. 25 Maximum tolerable peak current vs. pulse duration

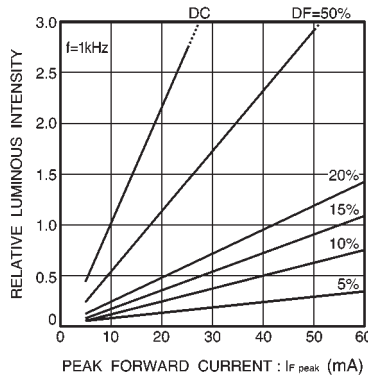

Fig. 26 Luminous intensity vs. peak forward current

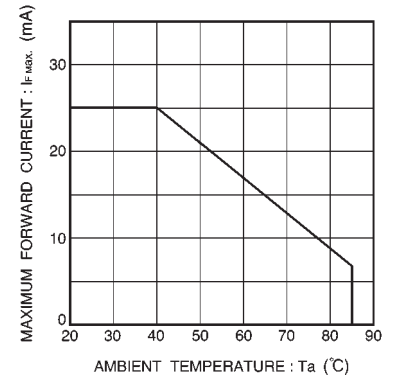

Fig. 27 Maximum forward current vs. ambient temperature