

## QED121, QED122, QED123 Plastic Infrared Light Emitting Diode

### Features

- $\lambda = 880\text{nm}$
- Chip material = AlGaAs
- Package type: T-1 3/4 (5mm lens diameter)
- Matched photosensor: QSD122/QSD123/QSD124
- Narrow emission angle,  $16^\circ$
- High output power
- Package material and color: clear, peach tinted, plastic

### Description

The QED121, QED122 and QED123 are 880nm AlGaAs LEDs encapsulated in a clear peach tinted, plastic T-1 3/4 package.

### Package Dimensions

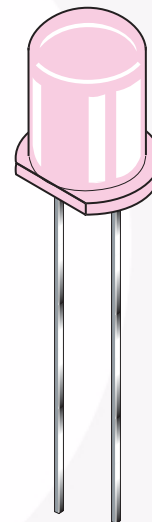
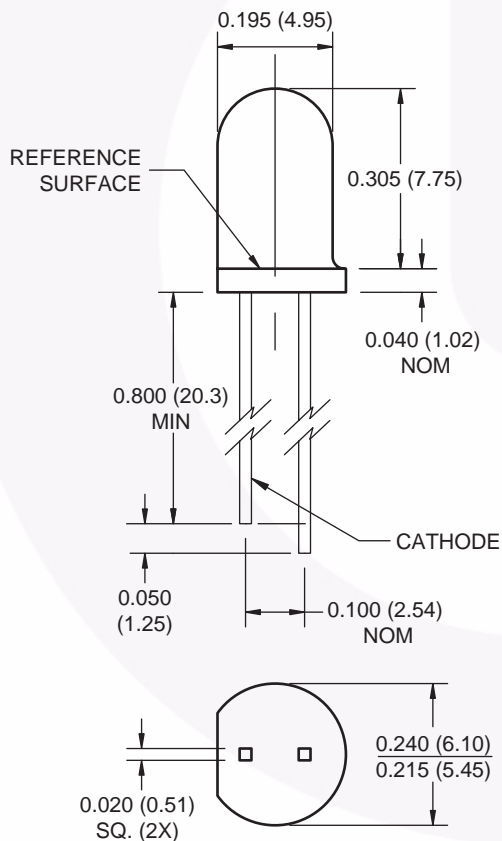

### Schematic

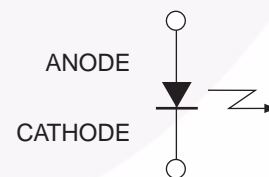

### Notes:

1. Dimensions of all drawings are in inches (mm).
2. Tolerance is  $\pm 0.010$  (0.25) on all non-nominal dimensions unless otherwise specified.

### Absolute Maximum Ratings ( $T_A = 25^\circ\text{C}$ unless otherwise specified)

Stresses exceeding the absolute maximum ratings may damage the device. The device may not function or be operable above the recommended operating conditions and stressing the parts to these levels is not recommended. In addition, extended exposure to stresses above the recommended operating conditions may affect device reliability. The absolute maximum ratings are stress ratings only.

Symbol	Parameter	Rating	Units
$T_{OPR}$	Operating Temperature	-40 to +100	$^\circ\text{C}$
$T_{STG}$	Storage Temperature	-40 to +100	$^\circ\text{C}$
$T_{SOL-I}$	Soldering Temperature (Iron) <sup>(2)(3)(4)</sup>	240 for 5 sec	$^\circ\text{C}$
$T_{SOL-F}$	Soldering Temperature (Flow) <sup>(2)(3)</sup>	260 for 10 sec	$^\circ\text{C}$
$I_F$	Continuous Forward Current	100	mA
$V_R$	Reverse Voltage	5	V
$P_D$	Power Dissipation <sup>(1)</sup>	200	mW

#### Notes:

- Derate power dissipation linearly 2.67mW/ $^\circ\text{C}$  above 25 $^\circ\text{C}$ .
- RMA flux is recommended.
- Methanol or isopropyl alcohols are recommended as cleaning agents.
- Soldering iron 1/16" (1.6mm) minimum from housing.

### Electrical / Optical Characteristics ( $T_A = 25^\circ\text{C}$ )

Symbol	Parameter	Test Conditions	Min.	Typ.	Max.	Units
$\lambda_{PE}$	Peak Emission Wavelength	$I_F = 20\text{mA}$		890		nm
$TC_\lambda$	Temperature Coefficient			0.2		nm/ $^\circ\text{C}$
$2\theta^{1/2}$	Emission Angle	$I_F = 100\text{mA}$		16		$^\circ$
$V_F$	Forward Voltage	$I_F = 100\text{mA}$ , $t_p = 20\text{ms}$			1.7	V
$TC_{VF}$	Temperature Coefficient			-6		mV/ $^\circ\text{C}$
$I_R$	Reverse Current	$V_R = 5\text{V}$			10	$\mu\text{A}$
$I_E$	Radiant Intensity QED121	$I_F = 100\text{mA}$ , $t_p = 20\text{ms}$	16		40	mW/sr
$I_E$	Radiant Intensity QED122	$I_F = 100\text{mA}$ , $t_p = 20\text{ms}$	32		100	mW/sr
$I_E$	Radiant Intensity QED123	$I_F = 100\text{mA}$ , $t_p = 20\text{ms}$	50	70		mW/sr
$TC_{IE}$	Temperature Coefficient			-0.3		%/ $^\circ\text{C}$
$t_r$	Rise Time	$I_F = 100\text{mA}$		900		ns
$t_f$	Fall Time			800		ns
$C_j$	Junction Capacitance	$V_R = 0\text{V}$		11		pF

## Typical Performance Curves

Figure 1. Normalized Intensity vs. Wavelength

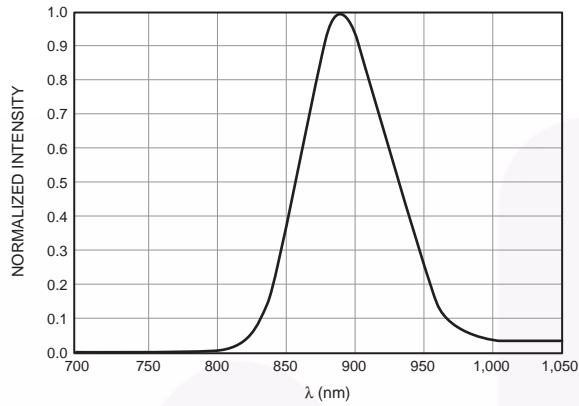

Figure 2. Peak Wavelength vs. Ambient Temperature

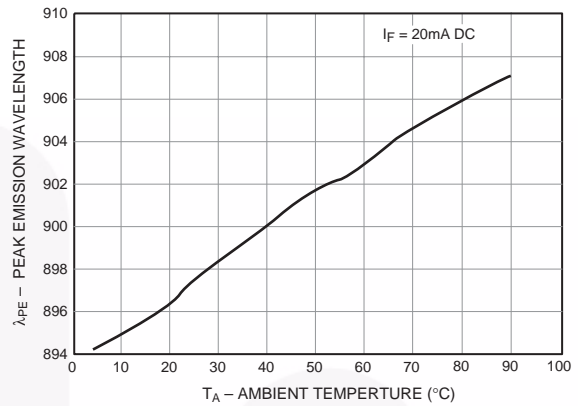

Figure 3. Normalized Radiant Intensity vs. Forward Current

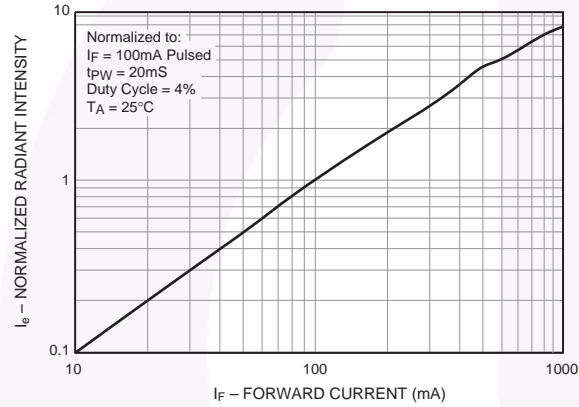

Figure 4. Normalized Radiant Intensity vs. Ambient Temperature

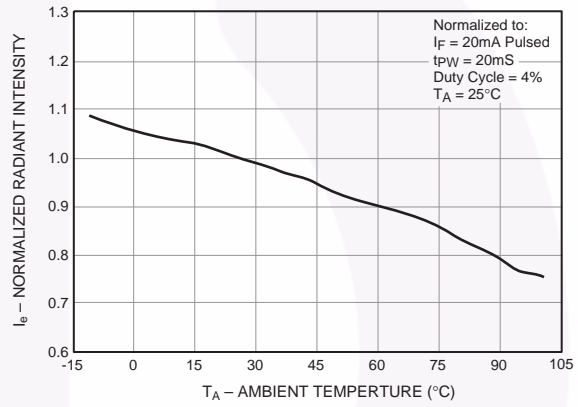

Figure 5. Forward Voltage vs. Forward Current

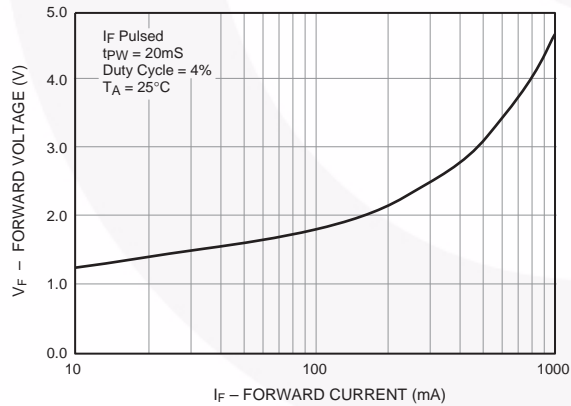
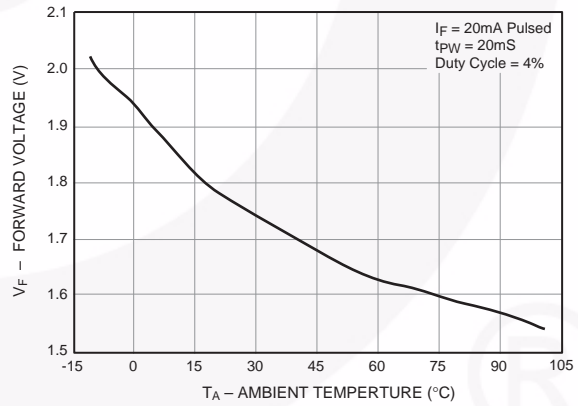

Figure 6. Forward Voltage vs. Ambient Temperature



Typical Performance Curves (Continued)

Figure 7. Radiation Diagram

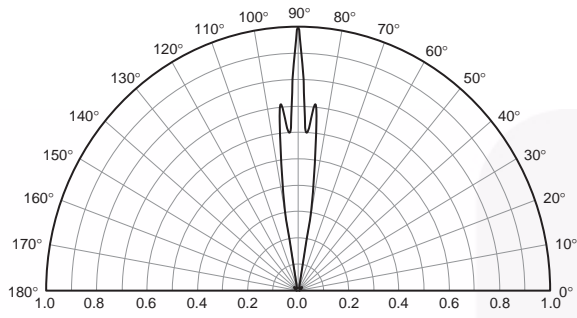
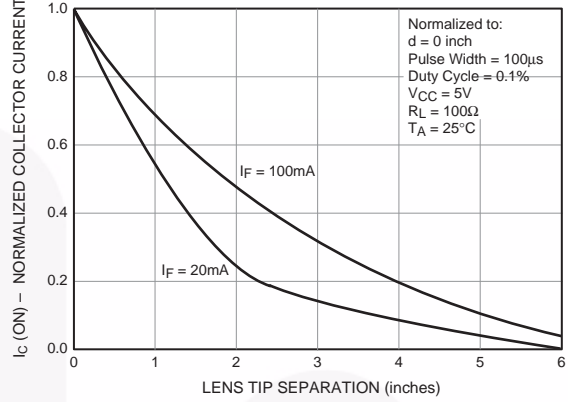







Figure 8. Coupling Characteristics of QED12X and QSD12X





**TRADEMARKS**

The following includes registered and unregistered trademarks and service marks, owned by Fairchild Semiconductor and/or its global subsidiaries, and is not intended to be an exhaustive list of all such trademarks.

- |                                                                                     |                                                                                     |                                                                                     |                                                                                       |
|-------------------------------------------------------------------------------------|-------------------------------------------------------------------------------------|-------------------------------------------------------------------------------------|---------------------------------------------------------------------------------------|
| Build it Now™                                                                       | F-PFS™                                                                              | PowerTrench®                                                                        | The Power Franchise®                                                                  |
| CorePLUS™                                                                           | FRFET®                                                                              | Programmable Active Droop™                                                          | the power franchise                                                                   |
| CorePOWER™                                                                          | Global Power Resource SM                                                            | QFET®                                                                               | TinyBoost™                                                                            |
| CROSSVOLT™                                                                          | Green FPS™                                                                          | QS™                                                                                 | TinyBuck™                                                                             |
| CTL™                                                                                | Green FPS™ e-Series™                                                                | Quiet Series™                                                                       | TinyLogic®                                                                            |
| Current Transfer Logic™                                                             | GTO™                                                                                | RapidConfigure™                                                                     | TINYOPTO™                                                                             |
| EcoSPARK®                                                                           | IntelliMAX™                                                                         |  ™ | TinyPower™                                                                            |
| EfficientMax™                                                                       | ISOPLANAR™                                                                          | Saving our world, 1mW/W/kW at a time™                                               | TinyPWM™                                                                              |
| EZSWITCH™ *                                                                         | MegaBuck™                                                                           | SmartMax™                                                                           | TinyWire™                                                                             |
|  ™ | MICROCOUPLER™                                                                       | SMART START™                                                                        | μSerDes™                                                                              |
|  ™ | MicroFET™                                                                           | SPM®                                                                                |  ™ |
| Fairchild®                                                                          | MicroPak™                                                                           | STEALTH™                                                                            | UHC®                                                                                  |
| Fairchild Semiconductor®                                                            | MillerDrive™                                                                        | SuperFET™                                                                           | Ultra FRFET™                                                                          |
| FACT Quiet Series™                                                                  | MotionMax™                                                                          | SuperSOT™-3                                                                         | UniFET™                                                                               |
| FACT®                                                                               | Motion-SPM™                                                                         | SuperSOT™-6                                                                         | VCX™                                                                                  |
| FAST®                                                                               | OPTOLOGIC®                                                                          | SuperSOT™-8                                                                         | VisualMax™                                                                            |
| FastvCore™                                                                          | OPTOPLANAR®                                                                         | SupreMOS™                                                                           |                                                                                       |
| FlashWriter® *                                                                      |  ™ | SyncFET™                                                                            |                                                                                       |
| FPS™                                                                                | PDP 3-PM™                                                                           |  ™ |                                                                                       |
|                                                                                     | Power-SPM™                                                                          |                                                                                     |                                                                                       |

\* EZSWITCH™ and FlashWriter® are trademarks of System General Corporation, used under license by Fairchild Semiconductor.

**DISCLAIMER**

FAIRCHILD SEMICONDUCTOR RESERVES THE RIGHT TO MAKE CHANGES WITHOUT FURTHER NOTICE TO ANY PRODUCTS HEREIN TO IMPROVE RELIABILITY, FUNCTION, OR DESIGN. FAIRCHILD DOES NOT ASSUME ANY LIABILITY ARISING OUT OF THE APPLICATION OR USE OF ANY PRODUCT OR CIRCUIT DESCRIBED HEREIN; NEITHER DOES IT CONVEY ANY LICENSE UNDER ITS PATENT RIGHTS, NOR THE RIGHTS OF OTHERS. THESE SPECIFICATIONS DO NOT EXPAND THE TERMS OF FAIRCHILD'S WORLDWIDE TERMS AND CONDITIONS, SPECIFICALLY THE WARRANTY THEREIN, WHICH COVERS THESE PRODUCTS.

**LIFE SUPPORT POLICY**

FAIRCHILD'S PRODUCTS ARE NOT AUTHORIZED FOR USE AS CRITICAL COMPONENTS IN LIFE SUPPORT DEVICES OR SYSTEMS WITHOUT THE EXPRESS WRITTEN APPROVAL OF FAIRCHILD SEMICONDUCTOR CORPORATION.

As used herein:

- Life support devices or systems are devices or systems which, (a) are intended for surgical implant into the body or (b) support or sustain life, and (c) whose failure to perform when properly used in accordance with instructions for use provided in the labeling, can be reasonably expected to result in a significant injury of the user.
- A critical component in any component of a life support, device, or system whose failure to perform can be reasonably expected to cause the failure of the life support device or system, or to affect its safety or effectiveness.

**ANTI-COUNTERFEITING POLICY**

Fairchild Semiconductor Corporation's Anti-Counterfeiting Policy. Fairchild's Anti-Counterfeiting Policy is also stated on our external website, [www.fairchildsemi.com](http://www.fairchildsemi.com), under Sales Support.

Counterfeiting of semiconductor parts is a growing problem in the industry. All manufacturers of semiconductor products are experiencing counterfeiting of their parts. Customers who inadvertently purchase counterfeit parts experience many problems such as loss of brand reputation, substandard performance, failed applications, and increased cost of production and manufacturing delays. Fairchild is taking strong measures to protect ourselves and our customers from the proliferation of counterfeit parts. Fairchild strongly encourages customers to purchase Fairchild parts either directly from Fairchild or from Authorized Fairchild Distributors who are listed by country on our web page cited above. Products customers buy either from Fairchild directly or from Authorized Fairchild Distributors are genuine parts, have full traceability, meet Fairchild's quality standards for handling and storage and provide access to Fairchild's full range of up-to-date technical and product information. Fairchild and our Authorized Distributors will stand behind all warranties and will appropriately address any warranty issues that may arise. Fairchild will not provide any warranty coverage or other assistance for parts bought from Unauthorized Sources. Fairchild is committed to combat this global problem and encourage our customers to do their part in stopping this practice by buying direct or from authorized distributors.

**PRODUCT STATUS DEFINITIONS**

**Definition of Terms**

Datasheet Identification	Product Status	Definition
Advance Information	Formative / In Design	Datasheet contains the design specifications for product development. Specifications may change in any manner without notice.
Preliminary	First Production	Datasheet contains preliminary data; supplementary data will be published at a later date. Fairchild Semiconductor reserves the right to make changes at any time without notice to improve design.
No Identification Needed	Full Production	Datasheet contains final specifications. Fairchild Semiconductor reserves the right to make changes at any time without notice to improve the design.
Obsolete	Not In Production	Datasheet contains specifications on a product that is discontinued by Fairchild Semiconductor. The datasheet is for reference information only.

Rev. I36