

GL560/GL561

Low Peak Forward Voltage Type φ 5 Resin Mold Package Infrared Emitting Diodes

■ Features

1. Low peak forward voltage suitable for battery drive
(V_{FM} : TYP.1.7V at I_{FM} : 0.5A)
2. φ 5 resin mold package

■ Applications

1. Infrared remote controllers for TVs, VCRs,
audio equipment and air conditioners

■ Model Lineup

Model	GL560	GL561
Radiant intensity TYP. (mW/sr)	14	25
Half intensity angle TYP. (°)	± 21	± 13

■ Absolute Maximum Ratings

(Ta=25°C)

Parameter	Symbol	Rating	Unit
Forward current	I_F	100	mA
*1 Peak forward current	I_{FM}	1	A
Reverse voltage	V_R	6	V
Power dissipation	P	150	mW
Operating temperature	T_{opr}	- 25 to + 85	°C
*2 Storage temperature	T_{stg}	- 40 to + 85	°C
Soldering temperature	T_{sol}	260	°C

*1 Pulse width <=100μs, Duty ratio=0.01

*2 For 10 seconds at the position of 2.6 mm from the resin edge

■ Electro-optical Characteristics

(Ta=25°C)

Parameter	Symbol	Conditions	MIN.	TYP.	MAX.	Unit
Forward voltage	V_F	$I_F = 50\text{mA}$	-	1.25	1.37	V
Peak forward voltage	V_{FM}	$I_{FM} = 0.5\text{A}$	-	1.7	2.5	V
Reverse current	I_R	$V_R = 3\text{V}$	-	-	10	μA
*3 Radiant intensity	GL560	$I_F = 50\text{mA}$	5	14	-	mW/sr
	GL561		12	25	-	
Peak emission wavelength	λ_p	$I_F = 5\text{mA}$	-	940	-	nm
Half intensity wavelength	$\Delta\lambda$	$I_F = 5\text{mA}$	-	45	-	nm
Terminal capacitance	C_t	$V_R = 0, f = 1\text{MHz}$	-	50	-	pF
Response frequency	fc	-	-	300	-	kHz
Half intensity angle	GL560	$I_F = 20\text{mA}$	-	± 21	-	°
	GL561		-	± 13	-	

*3 I_E : Value obtained by converting the value in power of radiant fluxes emitted at the solid angle of 0.01 sr (steradian) in the direction of mechanical axis of the lens portion into 1 sr or all those emitted from the light emitting diode.

■ Outline Dimensions

(Unit : mm)

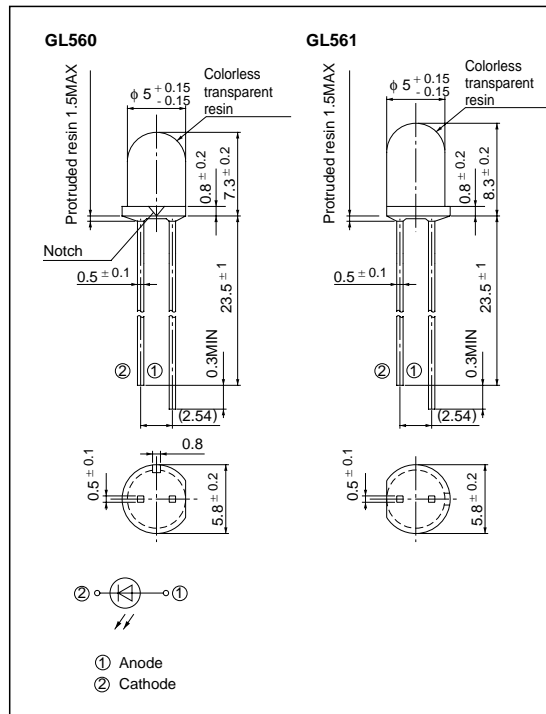

Fig. 1 Forward Current vs. Ambient Temperature

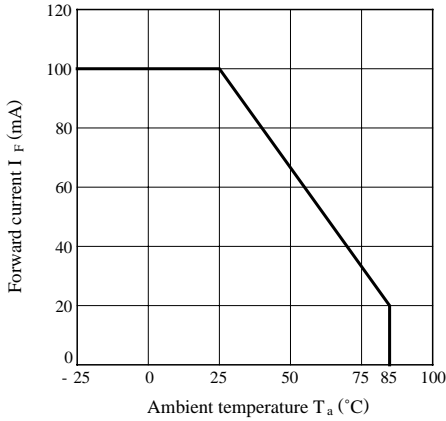

Fig. 2 Peak Forward Current vs. Duty Ratio

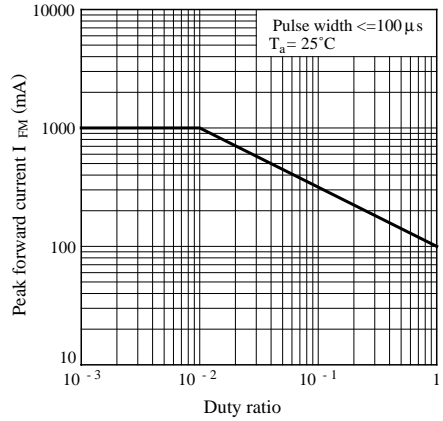

Fig. 3 Spectral Distribution

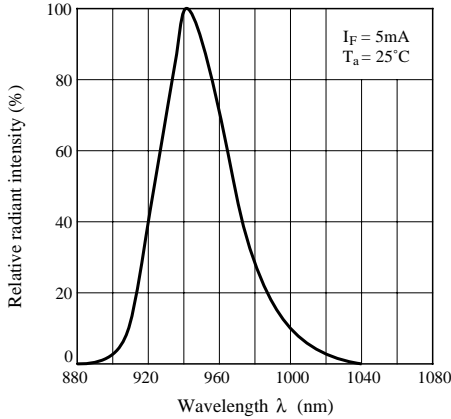

Fig. 4 Peak Emission Wavelength vs. Ambient Temperature

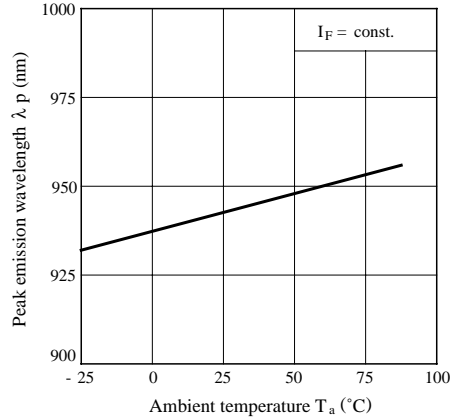

Fig. 5 Forward Current vs. Forward Voltage

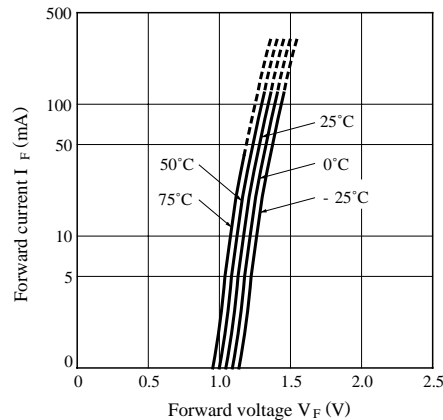

Fig. 6 Relative Forward Voltage vs. Ambient Temperature

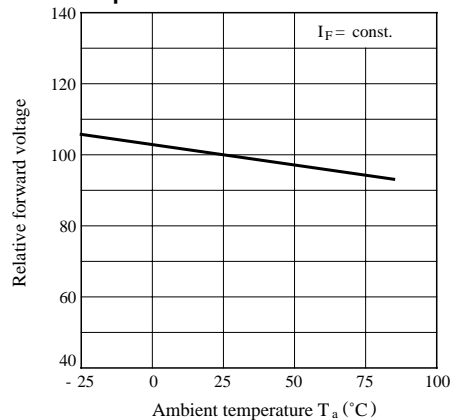

Fig. 7 Relative Radiant Output vs. Ambient Temperature (Detector : PD410PI)

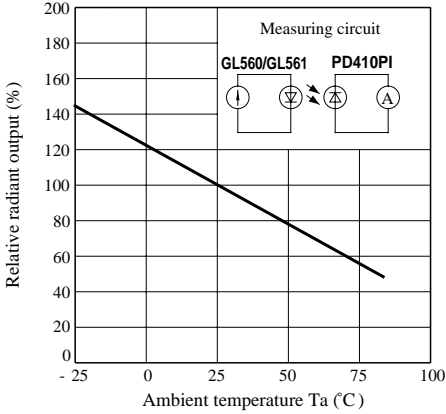

Fig. 8 Radiant Intensity vs. Forward Current

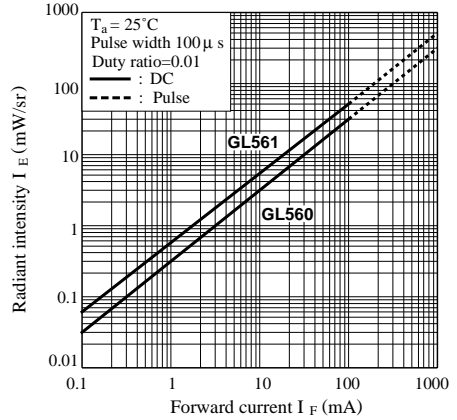

Fig. 9 Relative Output vs. Distance (Detector : PD410PI)

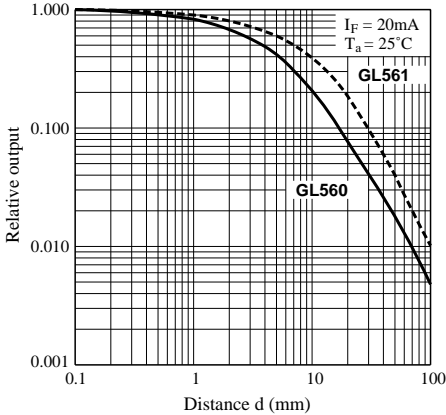

Fig. 10 Relative Output vs. Distance (Detector : PD49PI)

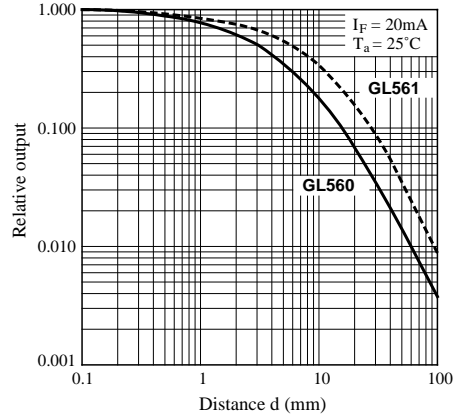

Fig. 11-a Radiation Diagram (GL560)

($T_a = 25^\circ\text{C}$)

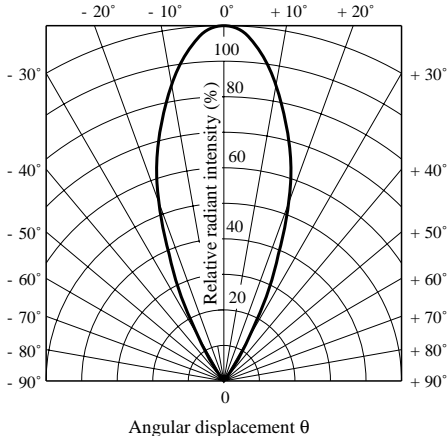
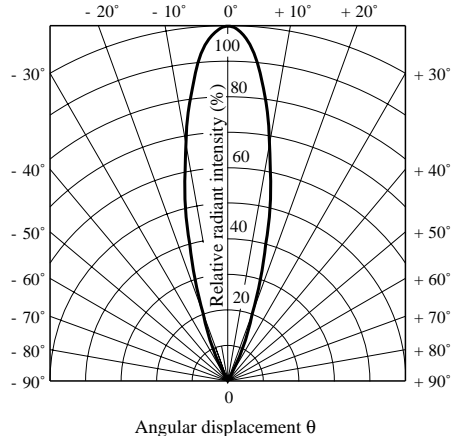

Fig. 11-b Radiation Diagram (GL561)

($T_a = 25^\circ\text{C}$)



NOTICE

- The circuit application examples in this publication are provided to explain representative applications of SHARP devices and are not intended to guarantee any circuit design or license any intellectual property rights. SHARP takes no responsibility for any problems related to any intellectual property right of a third party resulting from the use of SHARP's devices.
- Contact SHARP in order to obtain the latest device specification sheets before using any SHARP device. SHARP reserves the right to make changes in the specifications, characteristics, data, materials, structure, and other contents described herein at any time without notice in order to improve design or reliability. Manufacturing locations are also subject to change without notice.
- Observe the following points when using any devices in this publication. SHARP takes no responsibility for damage caused by improper use of the devices which does not meet the conditions and absolute maximum ratings to be used specified in the relevant specification sheet nor meet the following conditions:
 - (i) The devices in this publication are designed for use in general electronic equipment designs such as:
 - Personal computers
 - Office automation equipment
 - Telecommunication equipment [terminal]
 - Test and measurement equipment
 - Industrial control
 - Audio visual equipment
 - Consumer electronics
 - (ii) Measures such as fail-safe function and redundant design should be taken to ensure reliability and safety when SHARP devices are used for or in connection with equipment that requires higher reliability such as:
 - Transportation control and safety equipment (i.e., aircraft, trains, automobiles, etc.)
 - Traffic signals
 - Gas leakage sensor breakers
 - Alarm equipment
 - Various safety devices, etc.
 - (iii) SHARP devices shall not be used for or in connection with equipment that requires an extremely high level of reliability and safety such as:
 - Space applications
 - Telecommunication equipment [trunk lines]
 - Nuclear power control equipment
 - Medical and other life support equipment (e.g., scuba).
- Contact a SHARP representative in advance when intending to use SHARP devices for any "specific" applications other than those recommended by SHARP or when it is unclear which category mentioned above controls the intended use.
- If the SHARP devices listed in this publication fall within the scope of strategic products described in the Foreign Exchange and Foreign Trade Control Law of Japan, it is necessary to obtain approval to export such SHARP devices.
- This publication is the proprietary product of SHARP and is copyrighted, with all rights reserved. Under the copyright laws, no part of this publication may be reproduced or transmitted in any form or by any means, electronic or mechanical, for any purpose, in whole or in part, without the express written permission of SHARP. Express written permission is also required before any use of this publication may be made by a third party.
- Contact and consult with a SHARP representative if there are any questions about the contents of this publication.