

GL100MN_xMP Series

■ Features

1. Compact and thin package
2. Surface mount type
3. 2-way mounting; top view/side view
4. Reflow soldering
5. High output type: **GL100MN1MP**
6. General purpose type: **GL100MN0MP**
Pair use with **PT100MC0MP/PT100MF0MP** is recommended

■ Applications

1. Touch panel for ATM
2. Touch panel for Car navigation system
3. Touch panel for FA equipment

■ Absolute Maximum Ratings (T_a=25°C)

Parameter	Symbol	Rating	Unit
Forward current	I _F	50	mA
*1 Peak forward current	I _{FM}	0.5	A
Reverse voltage	V _R	6	V
Power dissipation	P	75	mW
Operating temperature	T _{opr}	-30 to +85	°C
Storage temperature	T _{stg}	-40 to +95	°C
*2 Soldering temperature	T _{sol}	240	°C

*1 Pulse width 100μs, duty 0.01

*2 Max. 10s

Compact, Surface Mount Type Infrared Emitting Diode

■ Outline Dimensions

(Unit : mm)

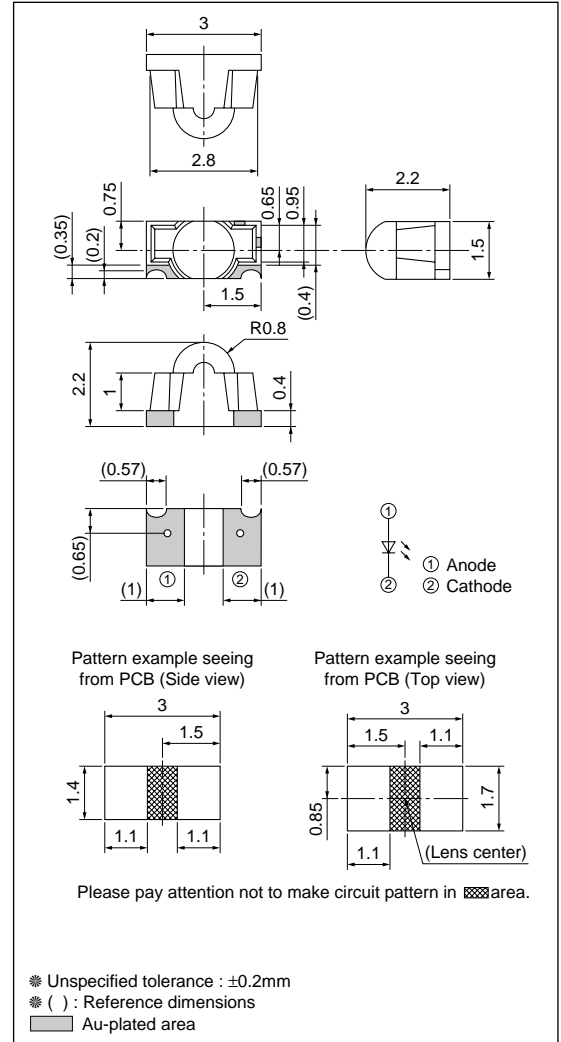

■ Electro-optical Characteristics

($T_a=25^{\circ}\text{C}$)

Parameter	Symbol	Conditions	MIN.	TYP.	MAX.	Unit
Forward voltage	GL100MN0MP	$I_F=20\text{mA}$	—	1.2	1.4	V
	GL100MN1MP	$I_F=20\text{mA}$	—	1.2	1.5	V
Peak forward voltage	V_{FM}	$I_{FM}=0.5\text{A}$	—	3.0	4.0	V
Reverse current	I_R	$V_R=3\text{V}$	—	—	10	μA
Radiant flux	GL100MN0MP	$I_F=20\text{mA}$	1.0	—	3.0	mW
	GL100MN1MP	$I_F=20\text{mA}$	2.0	—	6.0	mW
Peak emission wavelength	λ_p	$I_F=5\text{mA}$	—	940	—	nm
Half intensity wave length	$\Delta\lambda$	$I_F=5\text{mA}$	—	45	—	nm
Terminal capacitance	C_t	$V_R=0, f=1\text{MHz}$	—	50	—	pF
Response frequency	f_c	—	—	300	—	kHz
Half intensity angle	$\Delta\theta$	—	—	± 10	—	$^{\circ}$

Fig.1 Forward Current vs. Ambient Temperature

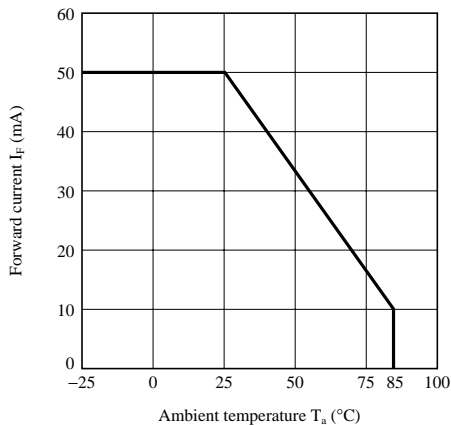

Fig.2 Peak Forward Current vs. Duty Ratio

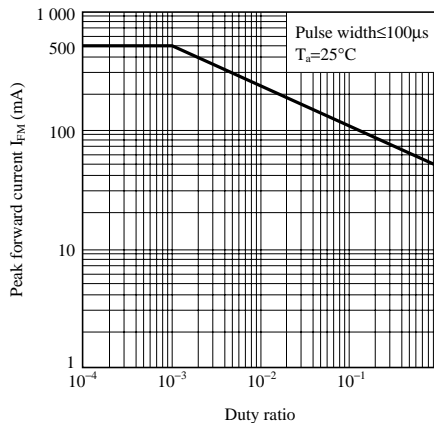

Fig.3 Spectral Distribution

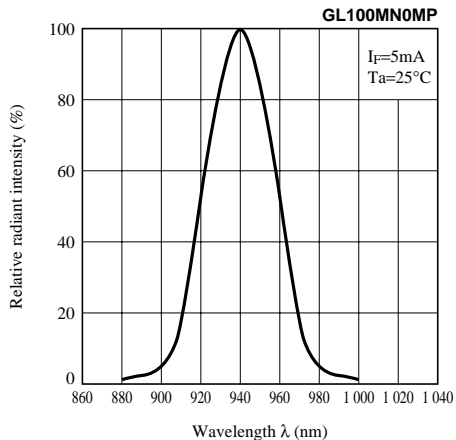

Fig.4 Spectral Distribution

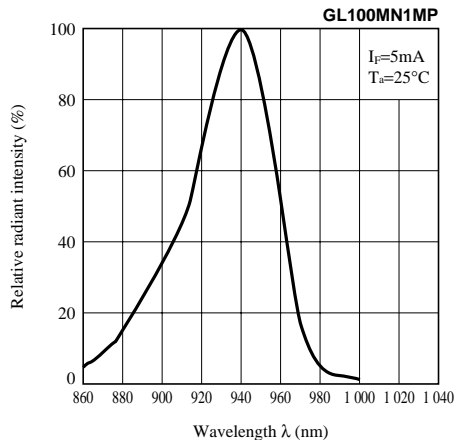

Fig.5 Peak Emission Wavelength vs. Ambient Temperature

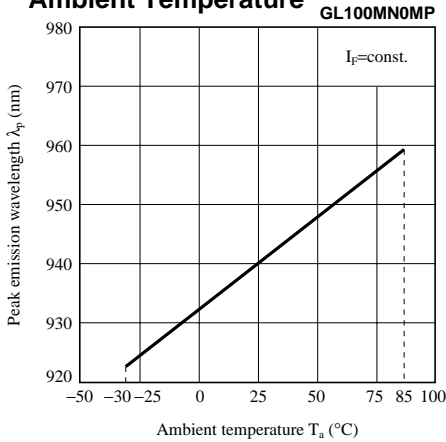

Fig.6 Peak Emission Wavelength vs. Ambient Temperature

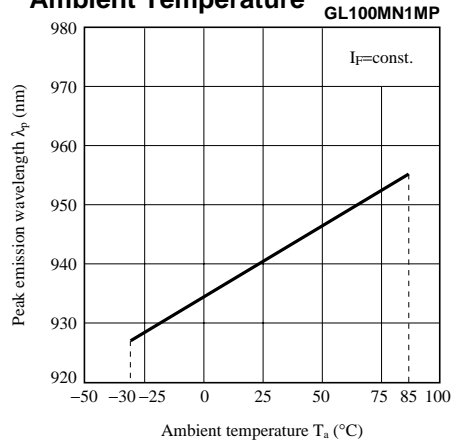

Fig.7 Forward Current vs. Forward Voltage

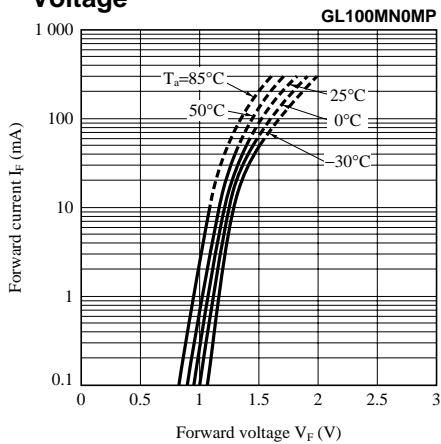

Fig.8 Forward Current vs. Forward Voltage

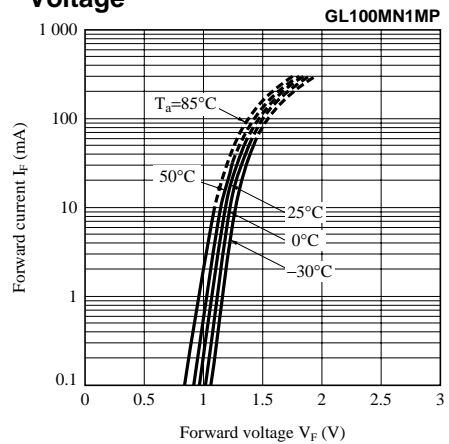

Fig.9 Relative Radiant Flux vs. Ambient Temperature

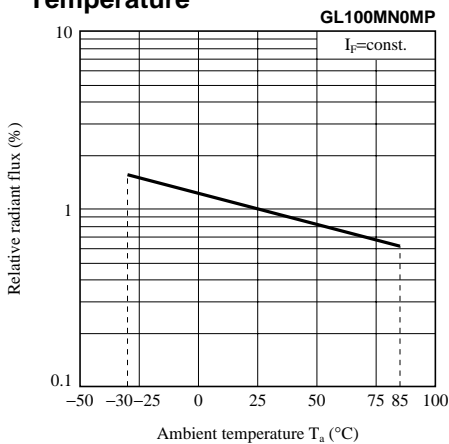

Fig.10 Relative Radiant Flux vs. Ambient Temperature

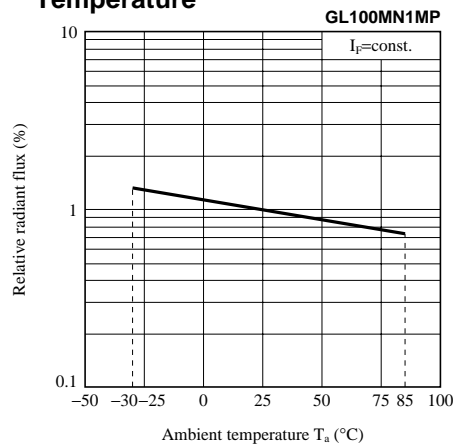

Fig.11 Radiant Flux vs. Forward Current

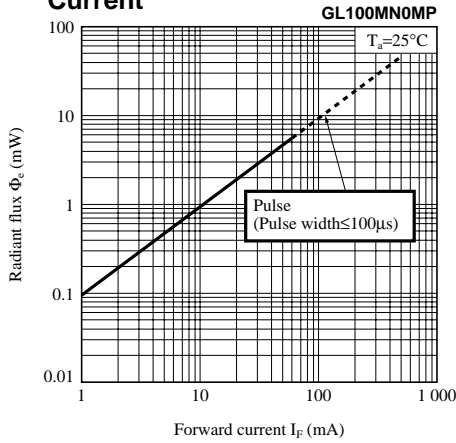

Fig.12 Radiant Flux vs. Forward Current

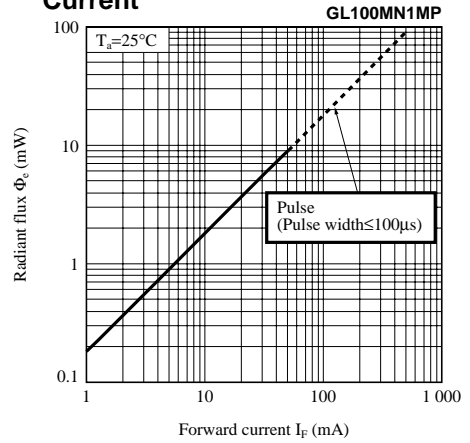

Fig.13 Relative Output vs. Distance To Detector

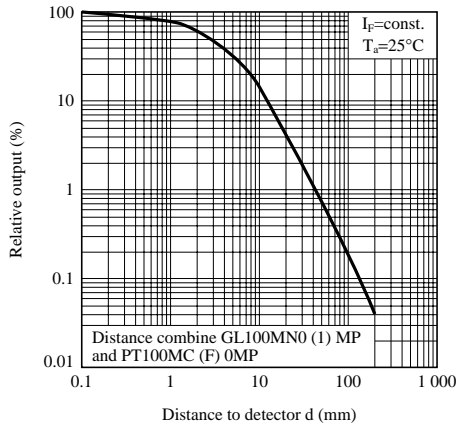

Fig.14 Radiation Diagram (Typical Value)

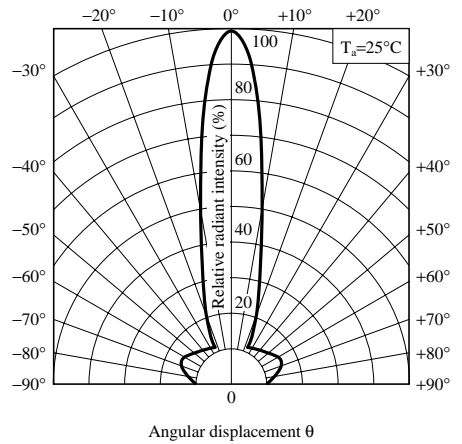
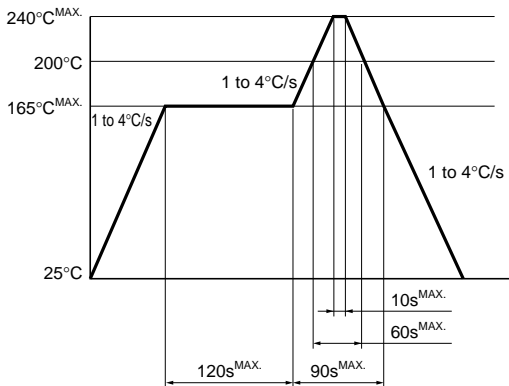

Fig.15 Reflow Soldering

Only one time soldering is recommended within the temperature profile shown below.



NOTICE

- The circuit application examples in this publication are provided to explain representative applications of SHARP devices and are not intended to guarantee any circuit design or license any intellectual property rights. SHARP takes no responsibility for any problems related to any intellectual property right of a third party resulting from the use of SHARP's devices.
- Contact SHARP in order to obtain the latest device specification sheets before using any SHARP device. SHARP reserves the right to make changes in the specifications, characteristics, data, materials, structure, and other contents described herein at any time without notice in order to improve design or reliability. Manufacturing locations are also subject to change without notice.
- Observe the following points when using any devices in this publication. SHARP takes no responsibility for damage caused by improper use of the devices which does not meet the conditions and absolute maximum ratings to be used specified in the relevant specification sheet nor meet the following conditions:
 - (i) The devices in this publication are designed for use in general electronic equipment designs such as:
 - Personal computers
 - Office automation equipment
 - Telecommunication equipment [terminal]
 - Test and measurement equipment
 - Industrial control
 - Audio visual equipment
 - Consumer electronics
 - (ii) Measures such as fail-safe function and redundant design should be taken to ensure reliability and safety when SHARP devices are used for or in connection with equipment that requires higher reliability such as:
 - Transportation control and safety equipment (i.e., aircraft, trains, automobiles, etc.)
 - Traffic signals
 - Gas leakage sensor breakers
 - Alarm equipment
 - Various safety devices, etc.
 - (iii) SHARP devices shall not be used for or in connection with equipment that requires an extremely high level of reliability and safety such as:
 - Space applications
 - Telecommunication equipment [trunk lines]
 - Nuclear power control equipment
 - Medical and other life support equipment (e.g., scuba).
- If the SHARP devices listed in this publication fall within the scope of strategic products described in the Foreign Exchange and Foreign Trade Law of Japan, it is necessary to obtain approval to export such SHARP devices.
- This publication is the proprietary product of SHARP and is copyrighted, with all rights reserved. Under the copyright laws, no part of this publication may be reproduced or transmitted in any form or by any means, electronic or mechanical, for any purpose, in whole or in part, without the express written permission of SHARP. Express written permission is also required before any use of this publication may be made by a third party.
- Contact and consult with a SHARP representative if there are any questions about the contents of this publication.