

GL0Z□042B0S series

Viewing Angle: 4° (2θ1/2) ø10mm,
Cylinder Type, Colorless
Transparency Super-luminosity
LED Lamps for Outdoor Use

■ Outline Dimensions

(Unit : mm)

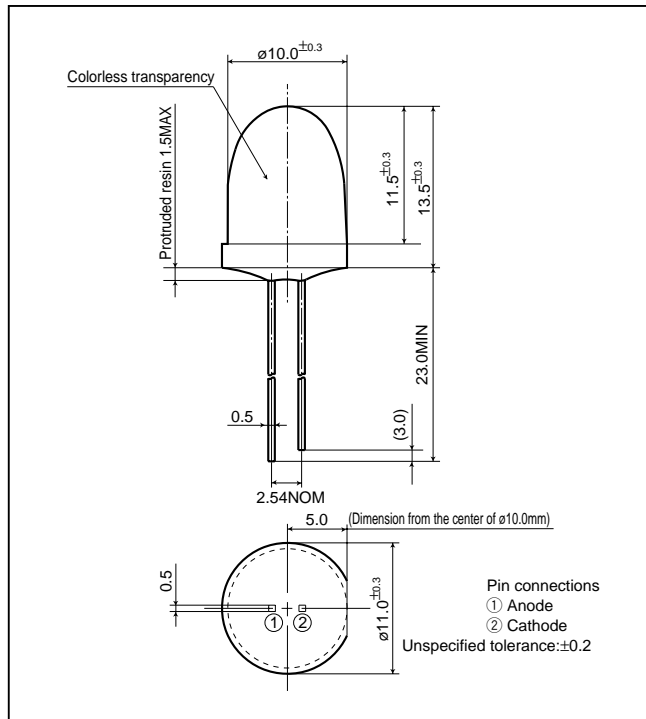

■ Directive Characteristics

(T_a=25°C)

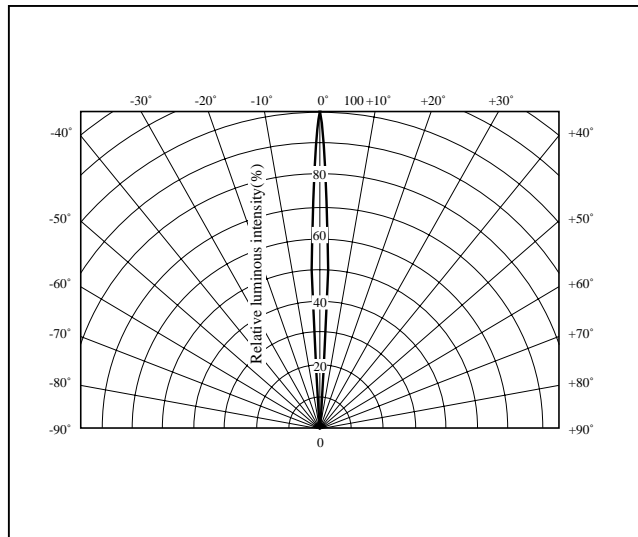

■ Absolute Maximum Ratings

(T_a=25°C)

Model No.	Emitting color	Material	Power dissipation P (mW)	Forward current I _F (mA)	Peak forward current I _{FM} *1 (mA)	Derating factor (mA/°C)		Reverse voltage V _R (V)	Operating temperature T _{opr} (°C)	Storage temperature T _{stg} (°C)	Soldering temperature T _{sol} *2 (°C)
						DC	Pulse				
GL0ZJ042B0S	Orange	AlGaInP on GaAs	130	50	100	0.67	1.33	5	-40 to +85	-40 to +100	260
GL0ZS042B0S	Sunset orange	AlGaInP on GaAs	130	50	100	0.67	1.33	5	-40 to +85	-40 to +100	260
GL0ZV042B0S	Amber	AlGaInP on GaAs	130	50	100	0.67	1.33	5	-40 to +85	-40 to +100	260

*1 Duty ratio=1/10, Pulse width=0.1ms

*2 5s or less(At the position of 1.6mm or more from the bottom face of resin package)

■ Electro-optical Characteristics

(I_F=20mA, T_a=25°C)

Lens type	Model No.	Forward voltage V _F (V)		Peak emission wavelength λ _p (nm) TYP	Dominant wavelength λ _d (nm) TYP	Luminous intensity I _v (mcd) TYP	Spectrum radiation bandwidth Δλ(nm) TYP	Reverse current		Terminal capacitance		Page for characteristics diagrams
		TYP	MAX					I _R (μA) MAX	V _R (V)	C _t (pF) TYP	(MHz)	
Colorless transparency	GL0ZJ042B0S	2.1	2.6	627	618	18 500	15	100	4	60	1	94
	GL0ZS042B0S	2.1	2.6	609	605	22 600	15	100	4	60	1	95
	GL0ZV042B0S	2.1	2.6	591	588	16 900	15	100	4	60	1	96

Characteristics Diagrams

ZR series

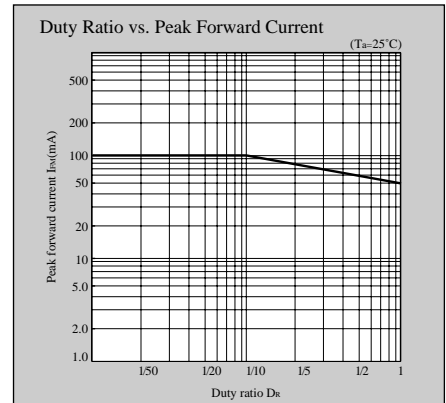
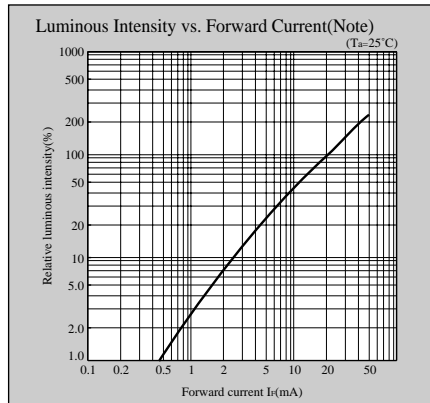
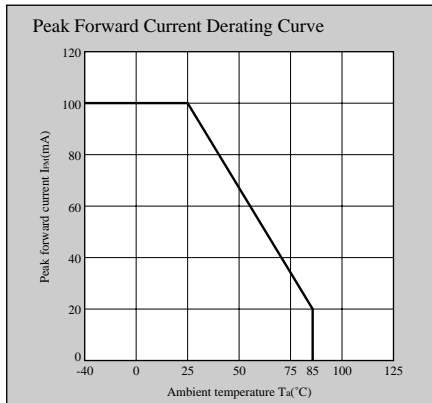
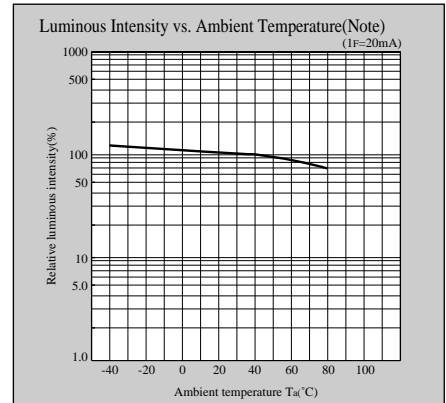
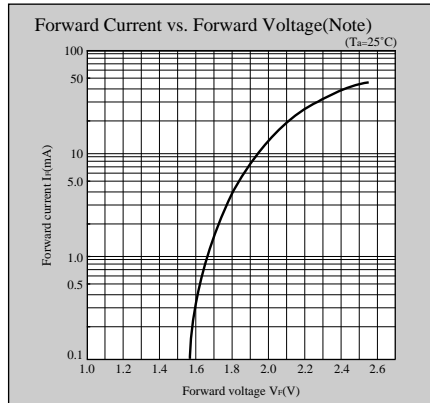
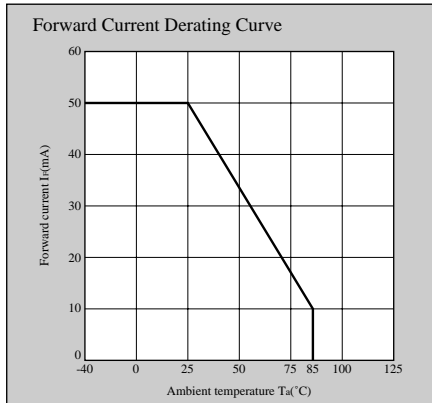

ZJ series

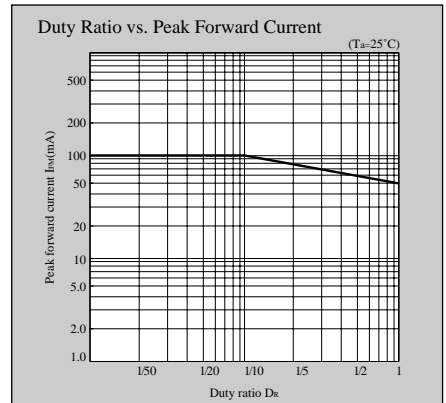
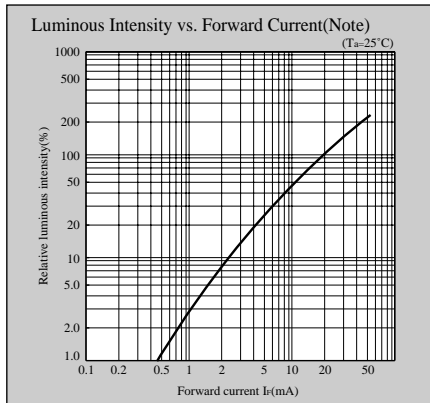
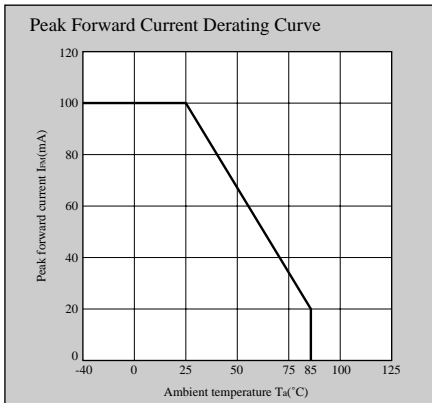
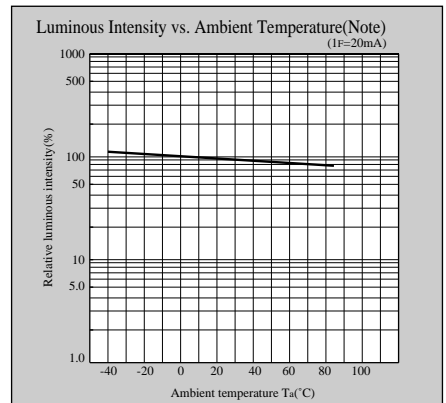
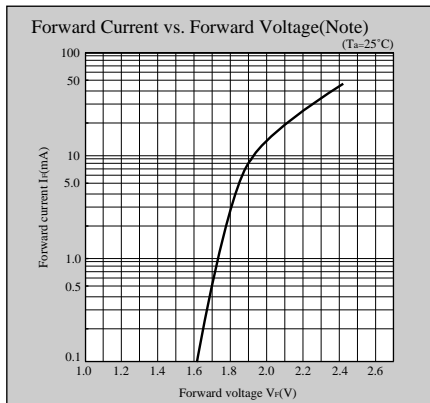
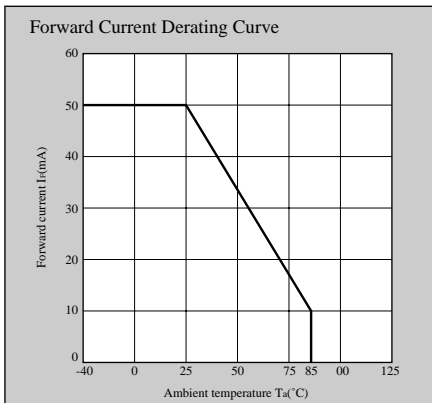

Note) Characteristics shown in diagrams are typical values. (not assurance value)

Characteristics Diagrams

ZS series

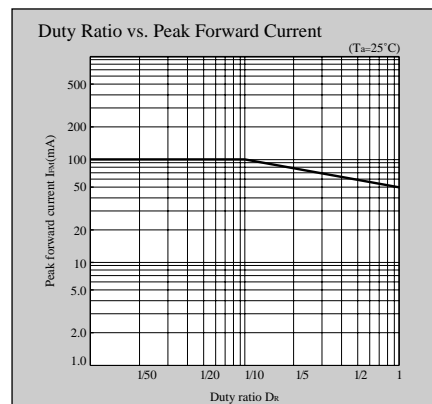
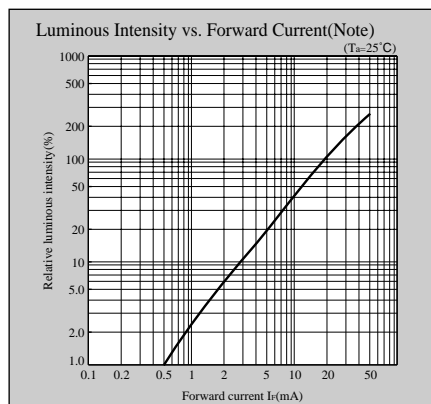
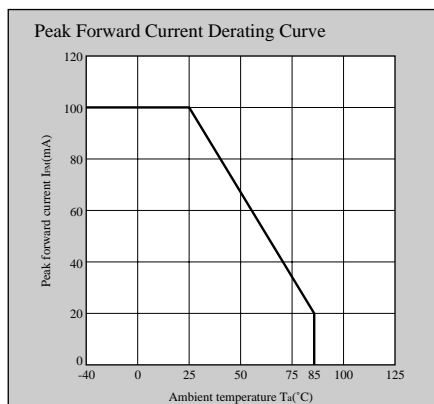
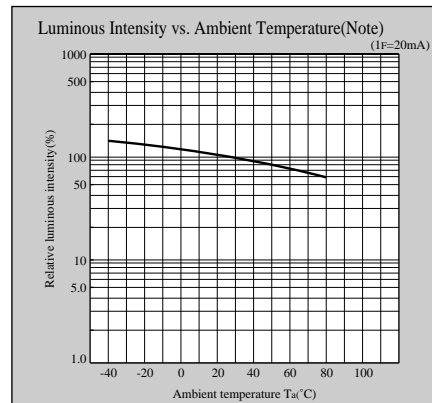
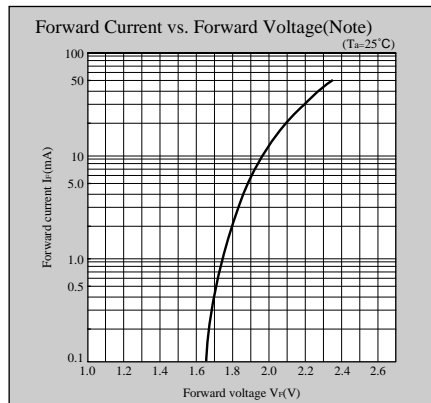
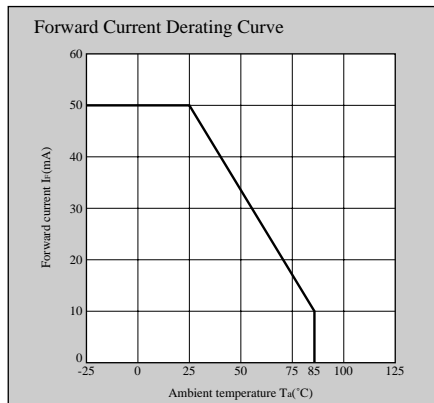

GL5XS022BOS

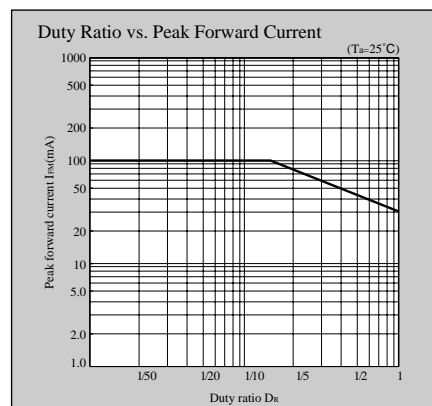
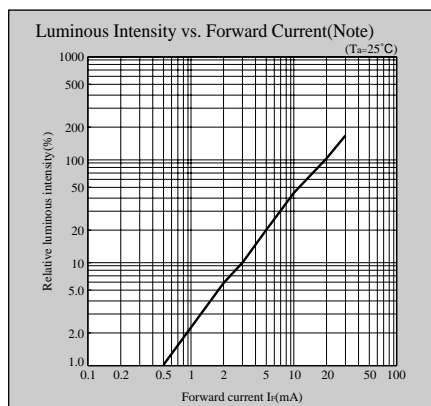
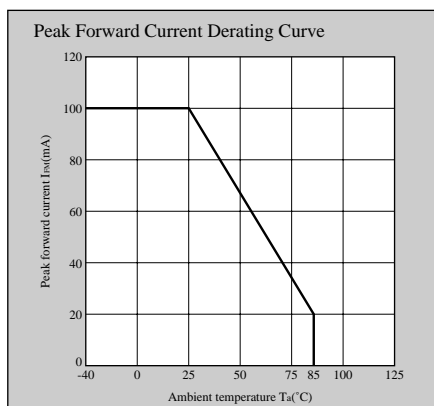
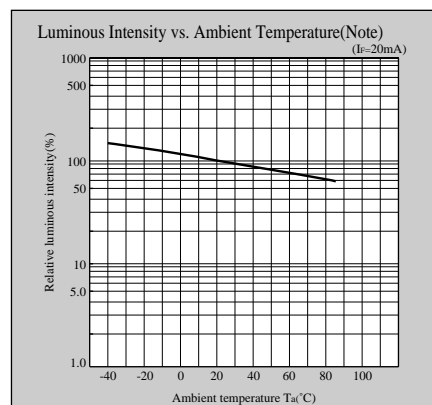
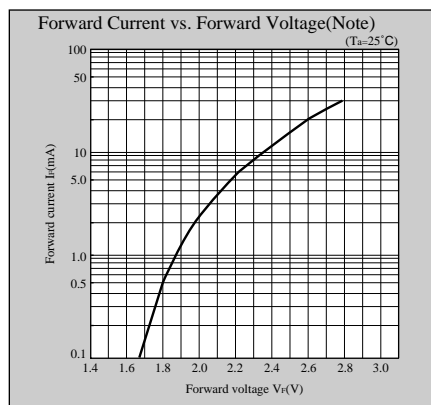
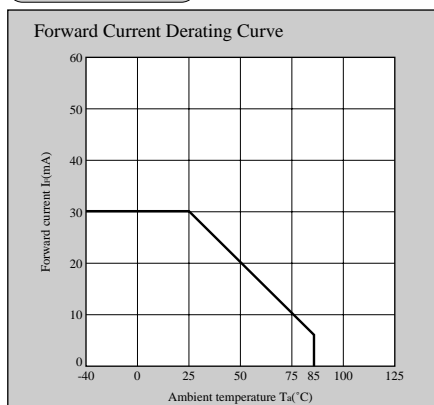

Note) Characteristics shown in diagrams are typical values. (not assurance value)

Characteristics Diagrams

ZV series

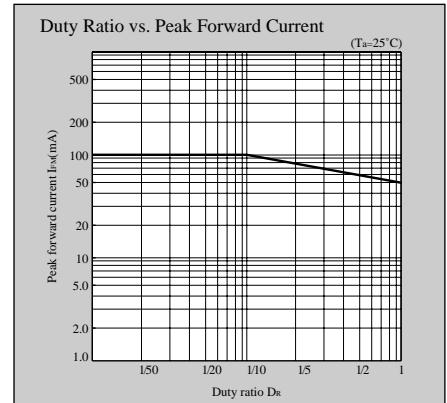
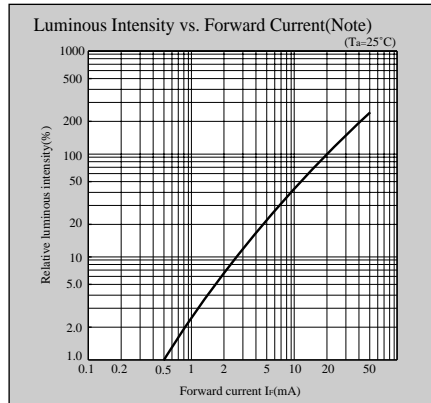
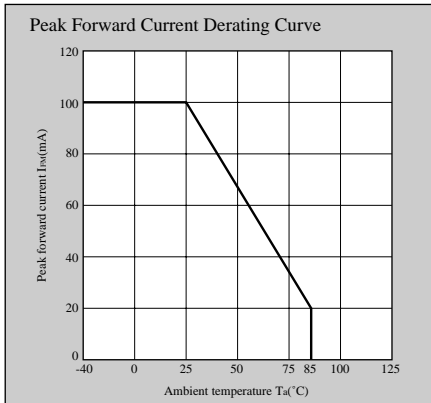
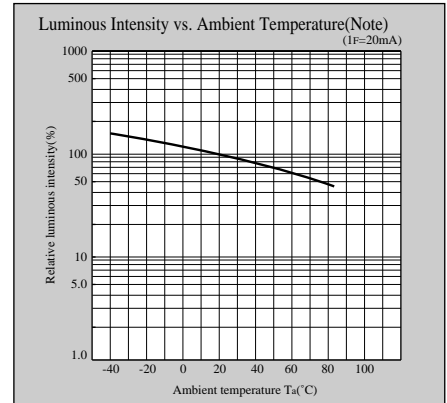
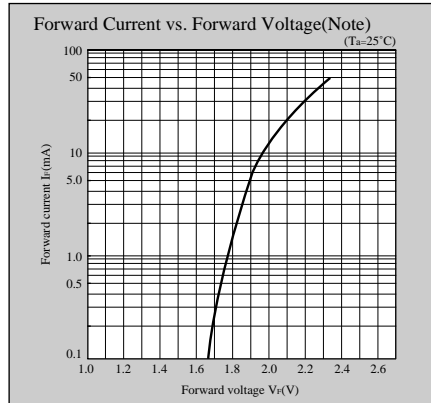
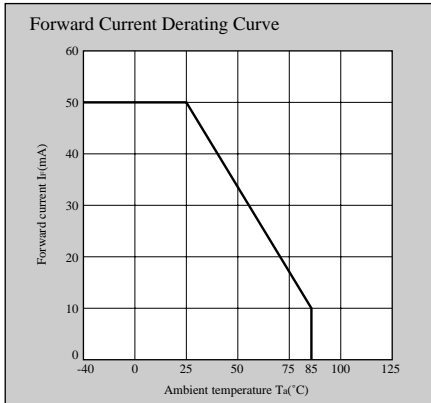

ZE series

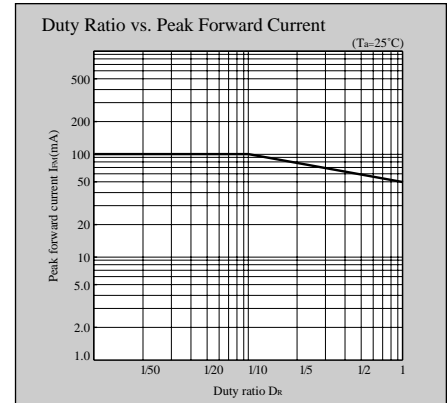
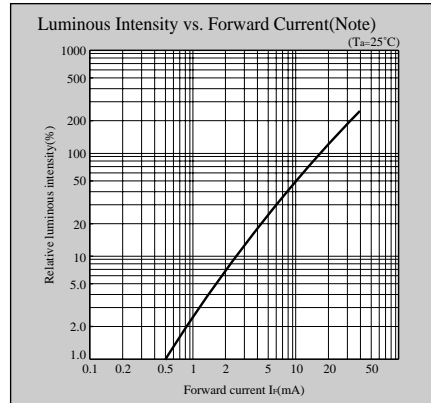
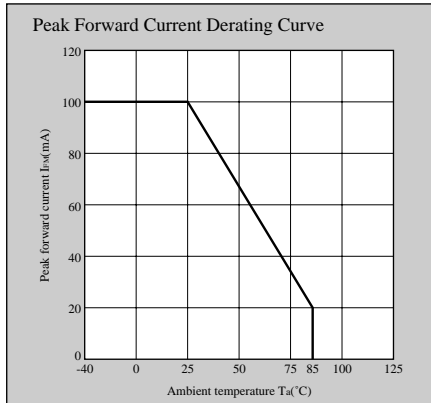
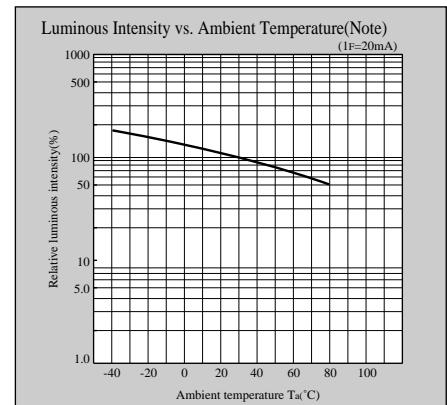
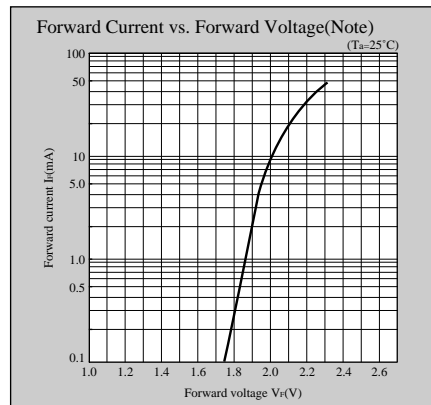
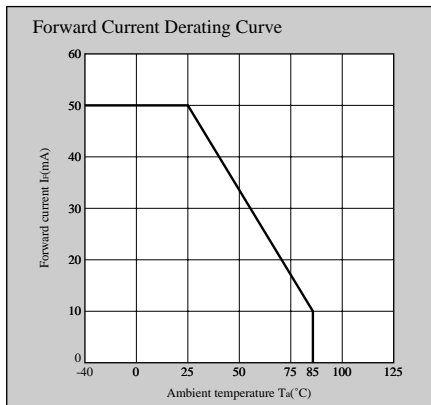

Note) Characteristics shown in diagrams are typical values. (not assurance value)

Taping Specifications

■ General Description

Sharp can supply tape-packaged LED lamps for automatic mounting. They will contribute to the high-efficiency mounting, high-precision, power saving. Please confirm before use because some products are not available in taping package.

■ Taping specification(Unit : mm, TYP. value)

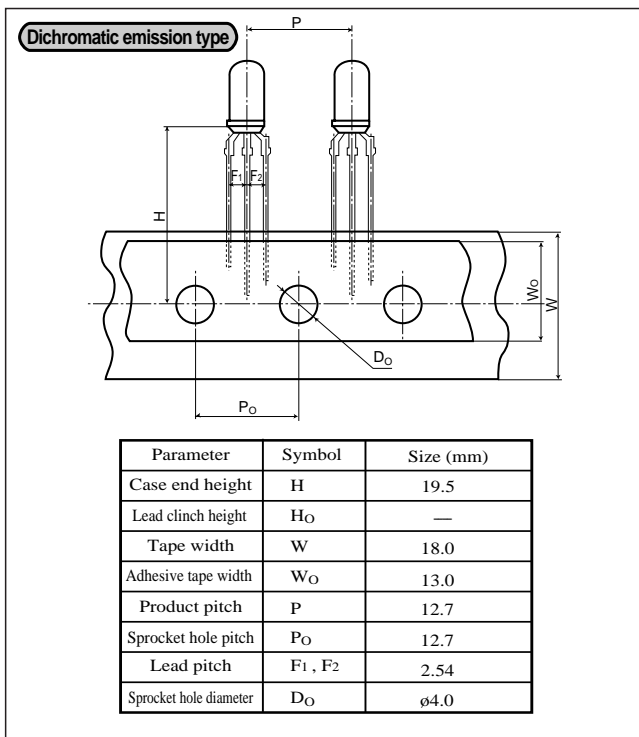
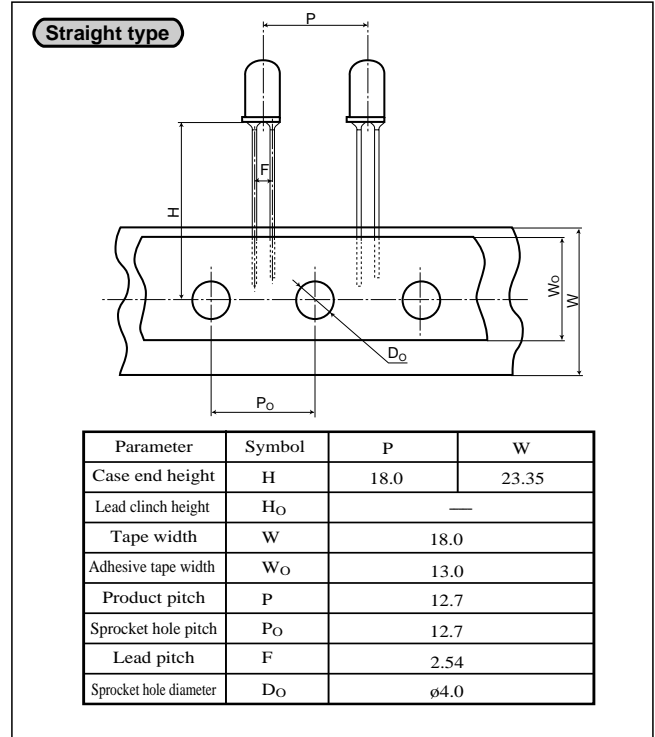
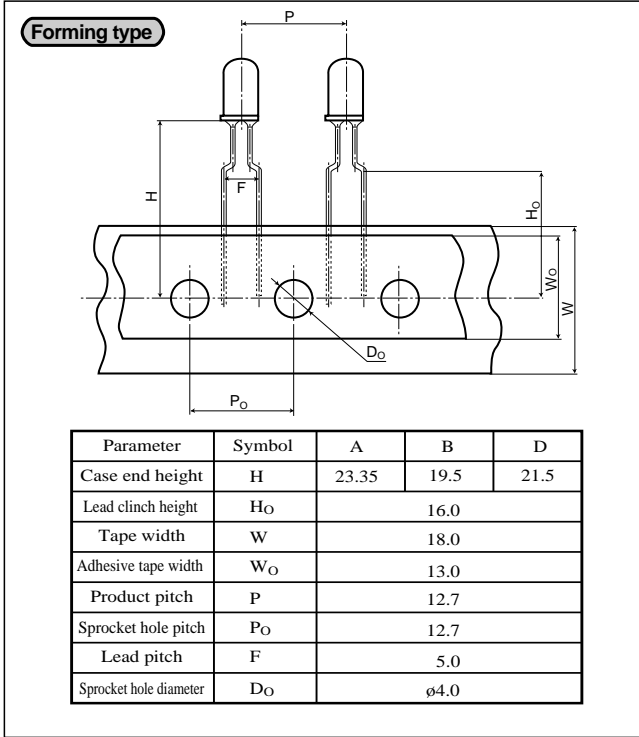

NOTICE

- The circuit application examples in this publication are provided to explain representative applications of SHARP devices and are not intended to guarantee any circuit design or license any intellectual property rights. SHARP takes no responsibility for any problems related to any intellectual property right of a third party resulting from the use of SHARP's devices.
- Contact SHARP in order to obtain the latest device specification sheets before using any SHARP device. SHARP reserves the right to make changes in the specifications, characteristics, data, materials, structure, and other contents described herein at any time without notice in order to improve design or reliability. Manufacturing locations are also subject to change without notice.
- Observe the following points when using any devices in this publication. SHARP takes no responsibility for damage caused by improper use of the devices which does not meet the conditions and absolute maximum ratings to be used specified in the relevant specification sheet nor meet the following conditions:
 - (i) The devices in this publication are designed for use in general electronic equipment designs such as:
 - Personal computers
 - Office automation equipment
 - Telecommunication equipment [terminal]
 - Test and measurement equipment
 - Industrial control
 - Audio visual equipment
 - Consumer electronics
 - (ii) Measures such as fail-safe function and redundant design should be taken to ensure reliability and safety when SHARP devices are used for or in connection with equipment that requires higher reliability such as:
 - Transportation control and safety equipment (i.e., aircraft, trains, automobiles, etc.)
 - Traffic signals
 - Gas leakage sensor breakers
 - Alarm equipment
 - Various safety devices, etc.
 - (iii) SHARP devices shall not be used for or in connection with equipment that requires an extremely high level of reliability and safety such as:
 - Space applications
 - Telecommunication equipment [trunk lines]
 - Nuclear power control equipment
 - Medical and other life support equipment (e.g., scuba).
- If the SHARP devices listed in this publication fall within the scope of strategic products described in the Foreign Exchange and Foreign Trade Law of Japan, it is necessary to obtain approval to export such SHARP devices.
- This publication is the proprietary product of SHARP and is copyrighted, with all rights reserved. Under the copyright laws, no part of this publication may be reproduced or transmitted in any form or by any means, electronic or mechanical, for any purpose, in whole or in part, without the express written permission of SHARP. Express written permission is also required before any use of this publication may be made by a third party.
- Contact and consult with a SHARP representative if there are any questions about the contents of this publication.