

EHP-A09K-S5TC-S3000CADA E1K-1T8-AM

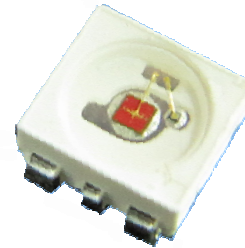

Lead (Pb) Free Product - RoHS Compliant



Features

- ◆ P-LCC-6 package.
- ◆ Small package with high efficiency.
- ◆ Colorless clear resin.
- ◆ Wide viewing angle 120°.
- ◆ Precondition: Bases on JEDEC J-STD 020D Level 2.
- ◆ Automotive reflow profile (IR reflow or wave soldering).

Applications

- ◆ Interior and exterior automotive lighting: turn light and indicating sign.
- ◆ Warning signs applied.
- ◆ Signal and symbol luminaries.
- ◆ Portable light source.
- ◆ Marker lights (e.g. steps, exit ways, etc.).
- ◆ Display for indoor and outdoor application.
- ◆ Substitution of traditional light for automotive use.
- ◆ General applications.

Table of Content

Product Nomenclature.....	3
Absolute Maximum Ratings.....	4
Electro-Optical Characteristics.....	5
Color Bins.....	6
Bin Range of Forward Voltage.....	7
Bin Range of Luminous Intensity.....	8
Typical Electro-Optical Characteristics Curves.....	9
Package Dimension.....	13
Carrier Tape Dimensions and Label Explanation.....	14
Reel Dimensions and Moisture Resistant Packing Process.....	15
Precautions for Using.....	16
Revision History.....	18

Product Nomenclature

EHP-A09K	-	R7T	C	-	A4000	DAEA	BA	K	-	1	T	8	-	AM
1		2	3		4	5	6	7		8	9	10		11

The product name is designated as below:

1.	Product type
2.	Chip code
3.	Resin color
4.	Wavelength or CIE coordinates
5.	Code of luminous intensity
6.	Forward voltage specification
7.	Operation current
8.	Packing quantities
9.	Packing method
10.	Forming types
11.	Specific
Code of automotive product	

Absolute Maximum Ratings (Ta=25°C)

Parameter	Symbol	Rating	Unit
Reverse Voltage	V_R	Not designed for reverse operation	V
Forward Current	I_F	150	mA
Peak Forward Current (Duty 1/10 @ 1KHz)	I_{FP}	250	mA
Power Dissipation	P_d	400	mW
Junction Temperature	T_j	150	°C
Operating Temperature	T_{opr}	-40 ~ +100	°C
Storage Temperature	T_{stg}	-40 ~ +110	°C
Thermal Resistance (AlGaInP)	$R_{th\ J-A}$	110	K/W
	$R_{th\ J-S}$	60	K/W
Thermal Resistance (InGaN)	$R_{th\ J-A}$	90	K/W
	$R_{th\ J-S}$	40	K/W
ESD (Classification acc. AEC Q101)	ESD_{HBM}	2000	V
	ESD_{MM}	200	V
Soldering Temperature	T_{sol}	Reflow Soldering : 260 °C for 30 sec. Hand Soldering : 350 °C for 3 sec.	

Electro-Optical Characteristics (Ta=25°C)

Parameter	Symbol	Min.	Typ.	Max.	Unit	Condition
Peak Wavelength	R	---	630	---	nm	I _F =150mA
	Y		598			
	G		522			
	B		460			
Dominant Wavelength	R	616	---	628	nm	I _F =150mA
	Y	583		595		
	G	516		528		
	B	448		467		
Spectrum Radiation Bandwidth	R	---	20	---	nm	I _F =150mA
	Y		15			
	G		30			
	B		20			
Viewing Angle	2θ _{1/2}	---	120	---	deg	I _F =150mA
Forward Voltage(AlGaInP)	V _F	1.70	---	3.20	V	I _F =150mA
Forward Voltage(InGaN)	V _F	2.75	---	4.25	V	I _F =150mA
Temperature coefficient of λ _p	TCλ _p	---	0.12	---	mV/K	I _F =150mA
Temperature coefficient of λ _d	TCλ _d	---	0.05	---	mV/K	I _F =150mA
Temperature coefficient of V _F (AlGaInP)	TC _V	---	-2.3	---	mV/K	I _F =150mA
Temperature coefficient of V _F (InGaN)	TC _V	---	-3.1	---	mV/K	I _F =150mA
Reverse Current	I _R	Not designed for reverse operation				

Note:

1. Tolerance of Luminous Intensity: ±11%
2. Tolerance of Dominant Wavelength: ±1nm
3. Tolerance of Forward Voltage: ±0.1V

Color Bins

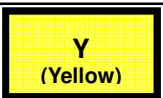
Group	Bin	Minimum Dominant	Maximum Dominant
		Wavelength (nm)	Wavelength (nm)
 R (Red)	1	616	619
	2	619	622
	3	622	625
	4	625	628
 Y (Yellow)	1	583	586
	2	586	589
	3	589	592
	4	592	595
 G (Green)	1	516	519
	2	519	522
	3	522	525
	4	525	528
 B (Blue)	1	448	451
	2	451	454
	3	454	457
	4	457	460
	5	460	464
	6	464	467

Note:

1. The standard shipping format for serial types includes a family group of 3 individual wavelength groups. Individual wavelength groups cannot be ordered.
2. Only one group will be shipped on each reel (there will be no mixing of two groups on each reel).

Bin Range of Forward Voltage

Group	Min.	Max.	Unit	Group	Min.	Max.	Unit
1	1.70	1.85	V	10	3.05	3.20	V
2	1.85	2.00		11	3.20	3.35	
3	2.00	2.15		12	3.35	3.50	
4	2.15	2.30		13	3.50	3.65	
5	2.30	2.45		14	3.65	3.80	
6	2.45	2.60		15	3.80	3.95	
7	2.60	2.75		16	3.95	4.10	
8	2.75	2.90		17	4.10	4.25	
9	2.90	3.05					

Note:

1. Forward Voltage Groups for Standard (AlGaInP $V_F = 1.7 \sim 3.2V$. InGaN $V_F = 2.75 \sim 4.25V$)

Bin Range of Luminous Intensity

Color	Min.	Max.	Unit	Luminous Flux(Φ_v)	Unit	Condition	Min.	Max.	Unit	Condition
R	2240	7100	mcd	11900 (typ.)	mlm	$I_F = 150\text{mA}$	140	450	mcd	$I_F = 10\text{mA}$
Y	2240	5600		9700 (typ.)			140	355		
G	4500	9000		19900 (typ.)			450	1120		
B	900	2800		4600 (typ.)			71	280		

Bin Code of Luminous Intensity

Group	Min.	Max.	Unit	Condition
V2	900	1120	mcd	$I_F = 150\text{mA}$
AA	1120	1400		
AB	1400	1800		
BA	1800	2240		
BB	2240	2800		
CA	2800	3550		
CB	3550	4500		
DA	4500	5600		
DB	5600	7100		
EA	7100	9000		

Note:

1. The standard shipping format for serial types includes a family group of 3 individual brightness groups. Individual brightness groups cannot be ordered.
2. Only one group will be shipped on each reel (there will be no mixing of two groups on each reel).

Typical Electro-Optical Characteristics Curves Typical Curve of Spectral Distribution

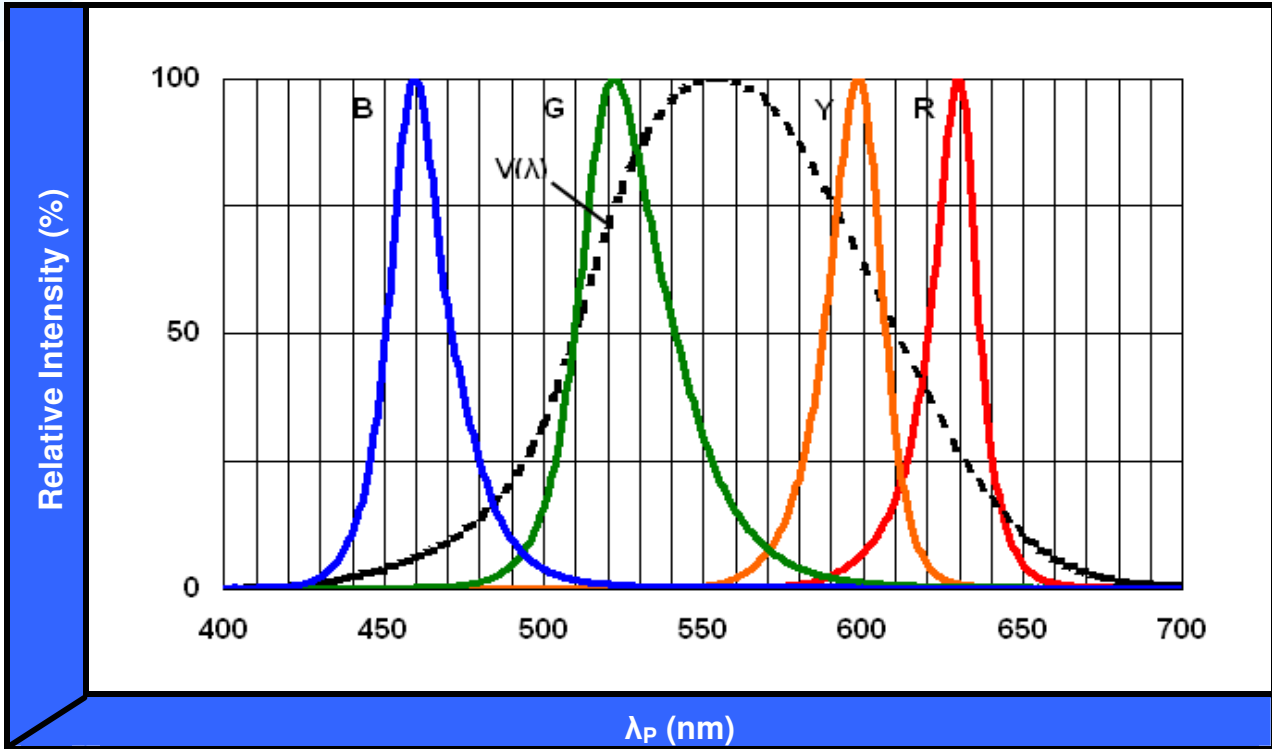

Note: $V(\lambda)$ =Standard eye response curve; $I_F = 150\text{mA}$

Diagram Characteristics of Radiation

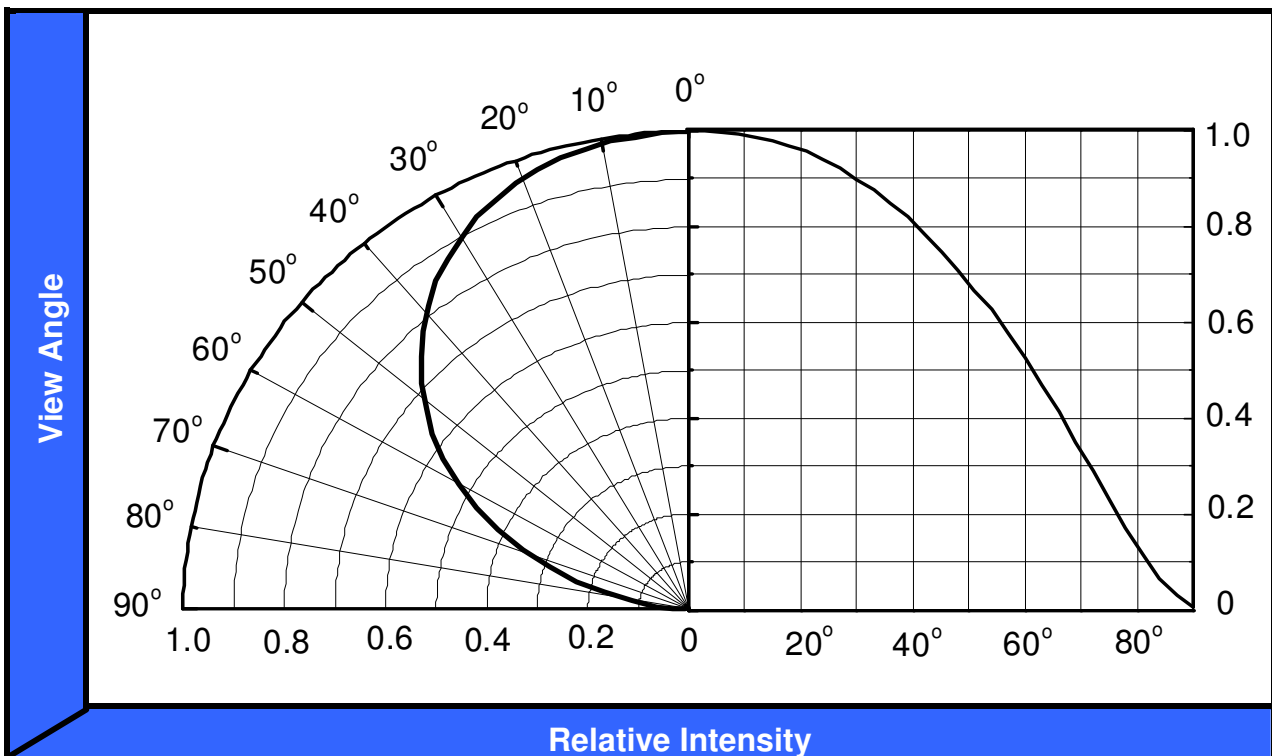

Forward Current vs. Forward Voltage (Ta=25 °C)

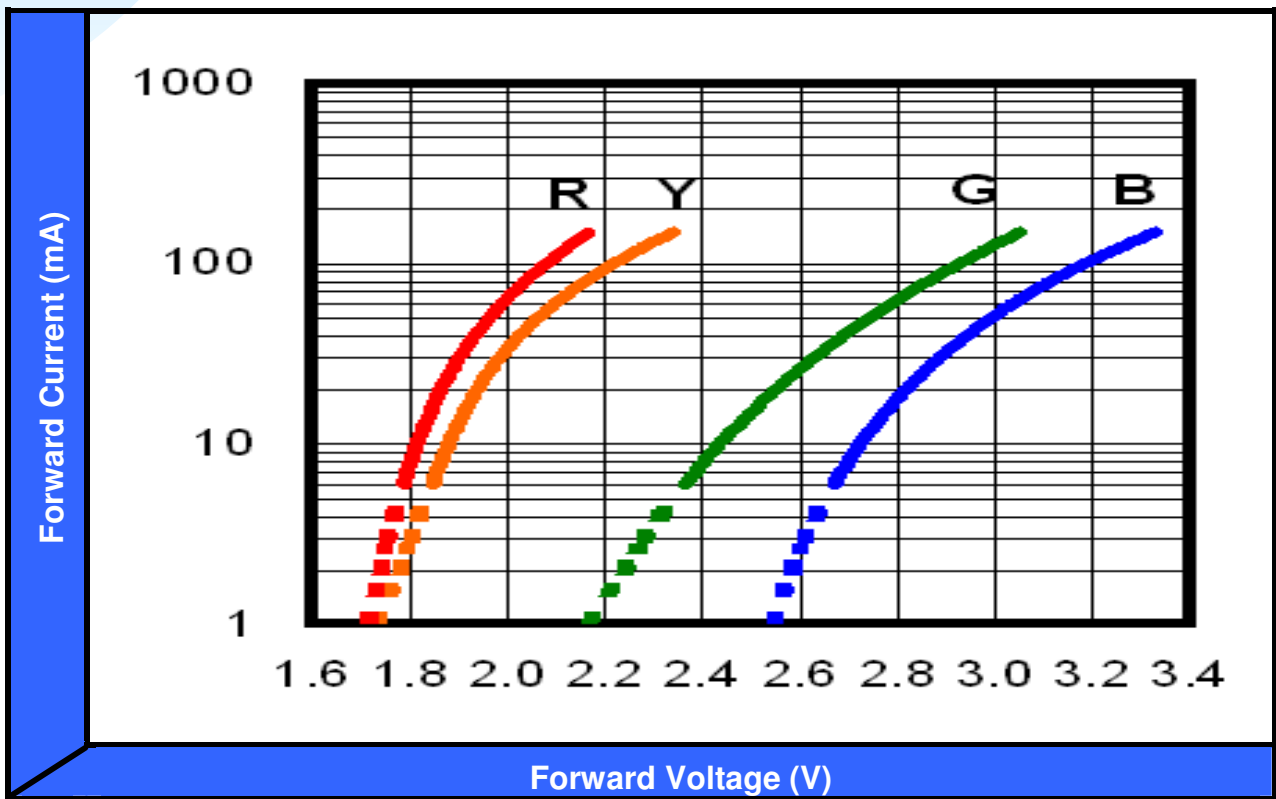

Dominant Wavelength vs. Forward Current (Ta=25 °C)

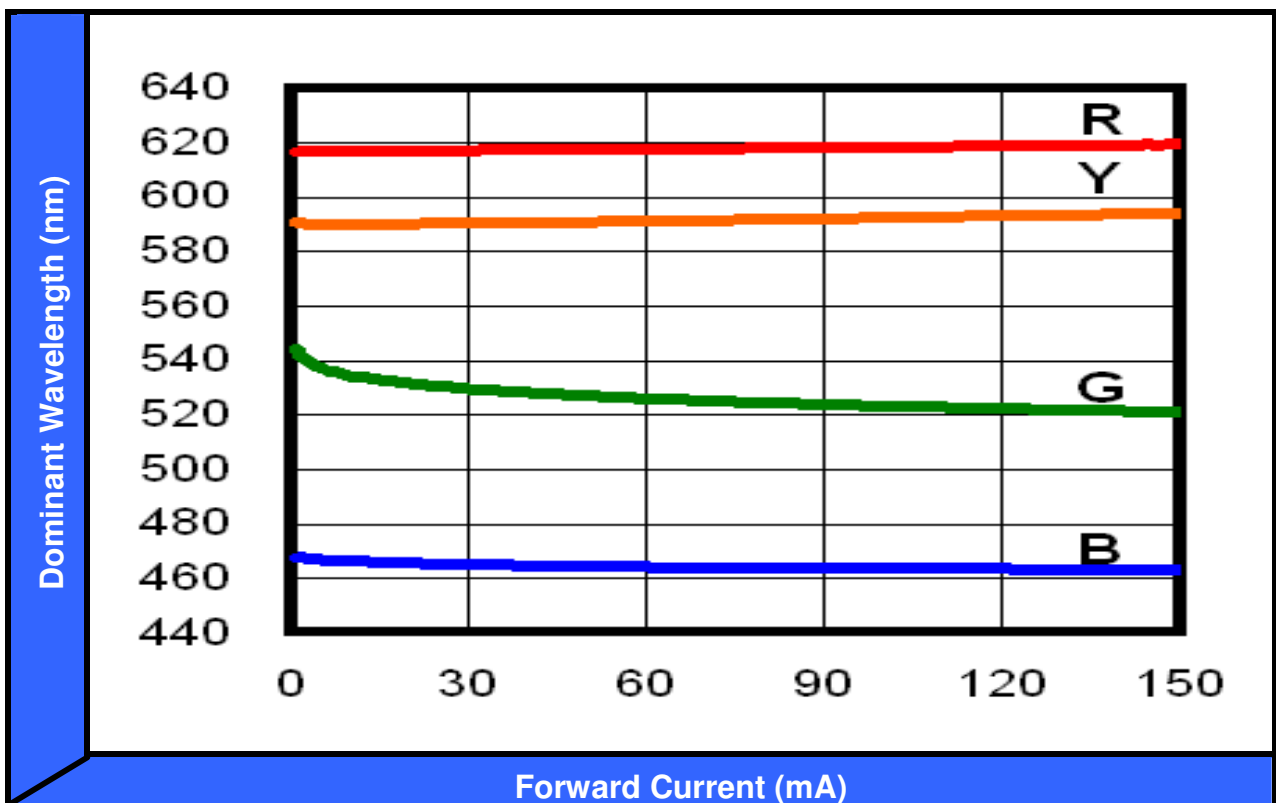

Relative Luminous Intensity vs. Forward Current (Ta=25 °C)

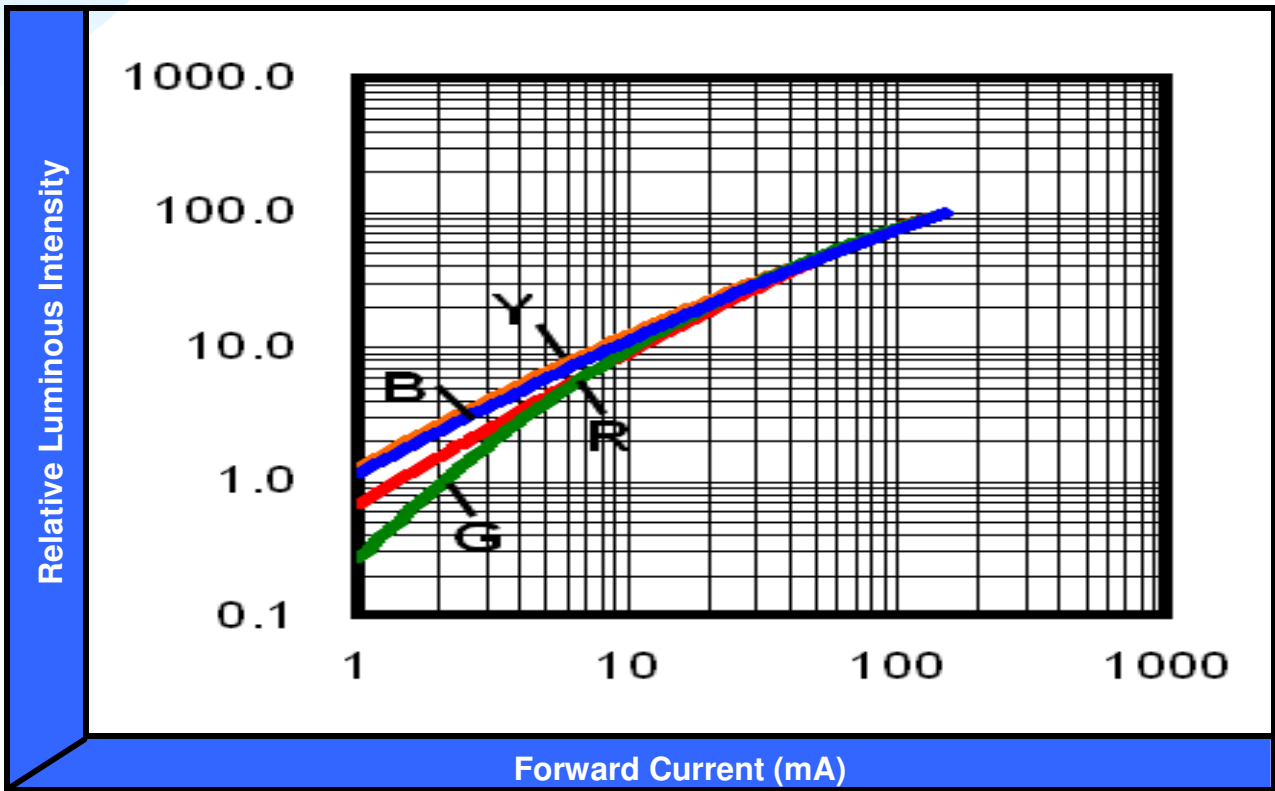

Max. Permissible Forwarded Current (Ta=25 °C)

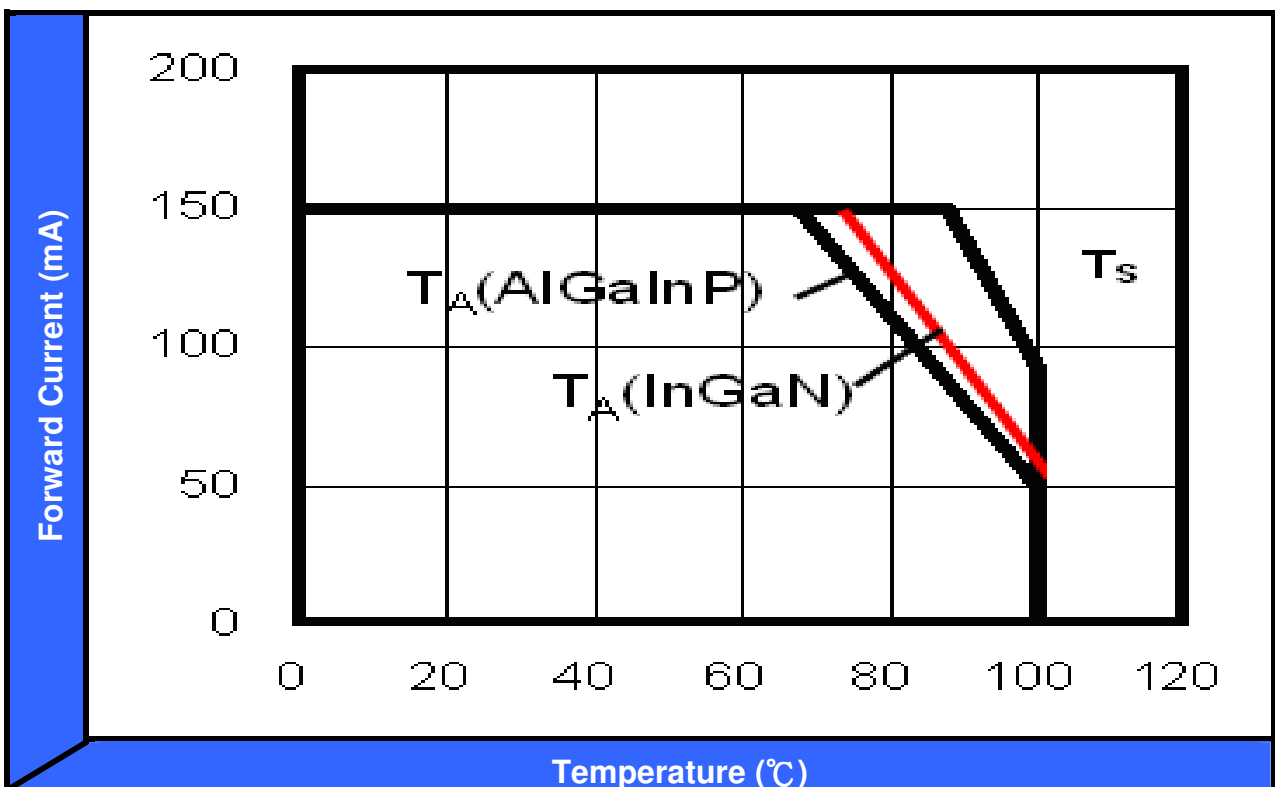

Relative Luminous Intensity vs. Junction Temperature

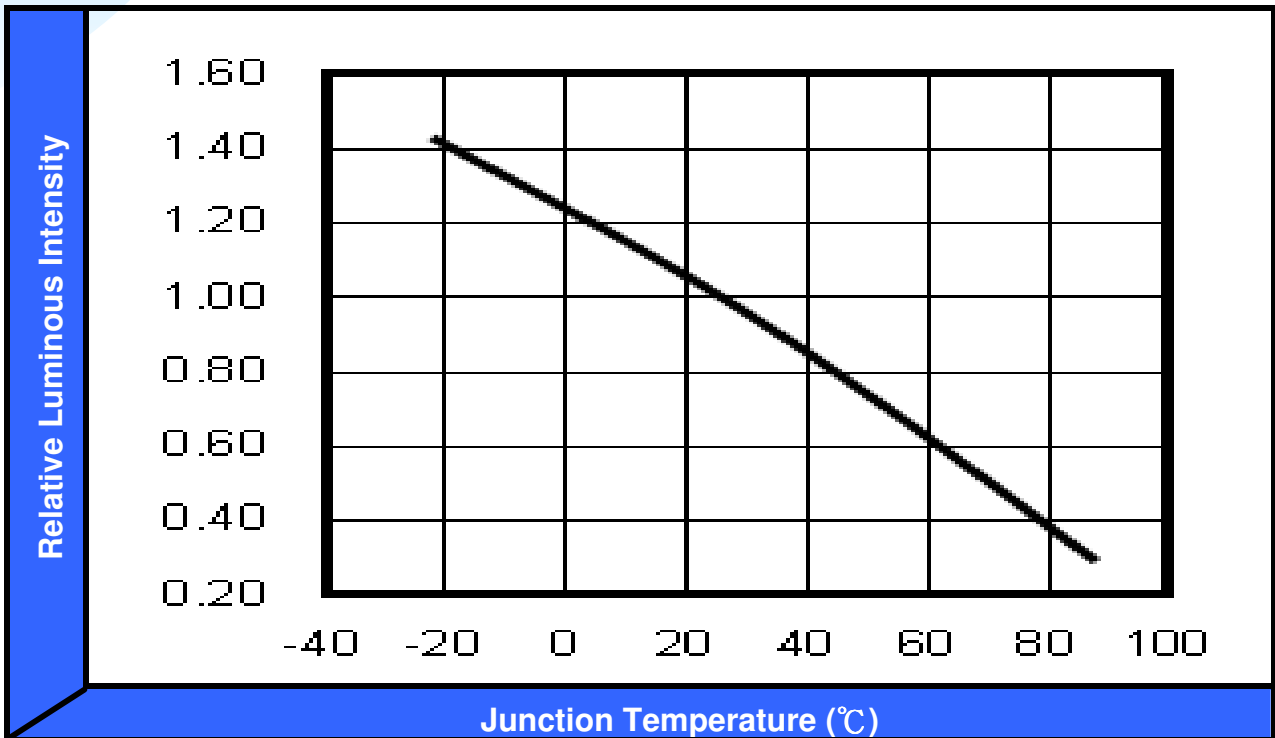

Note: $f(T_j) = I_v / I_v(25^\circ\text{C})$; $I_F = 150\text{mA}$

Relative Forward Voltage vs. Junction Temperature

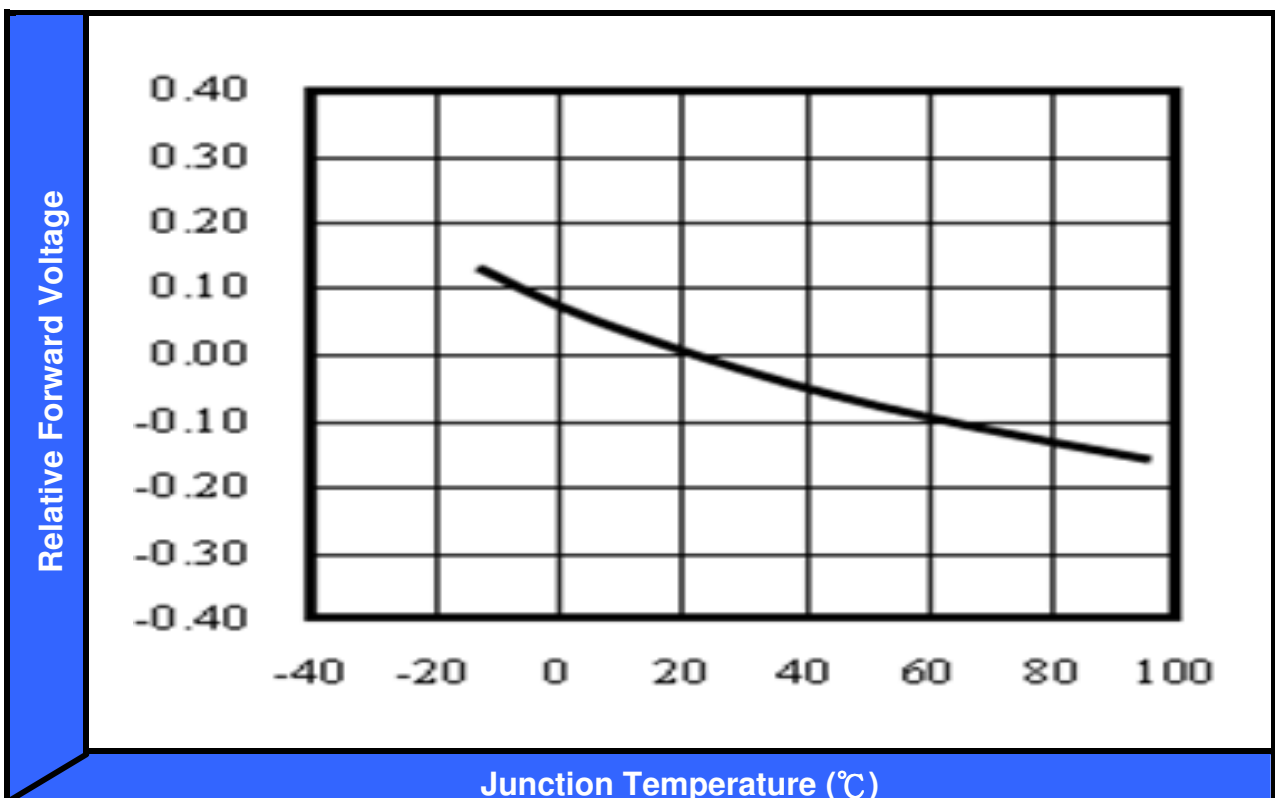

Note: $\Delta V_F = V_F - V_F(25^\circ\text{C}) = f(T_j)$; $I_F = 150\text{mA}$

Package Dimension

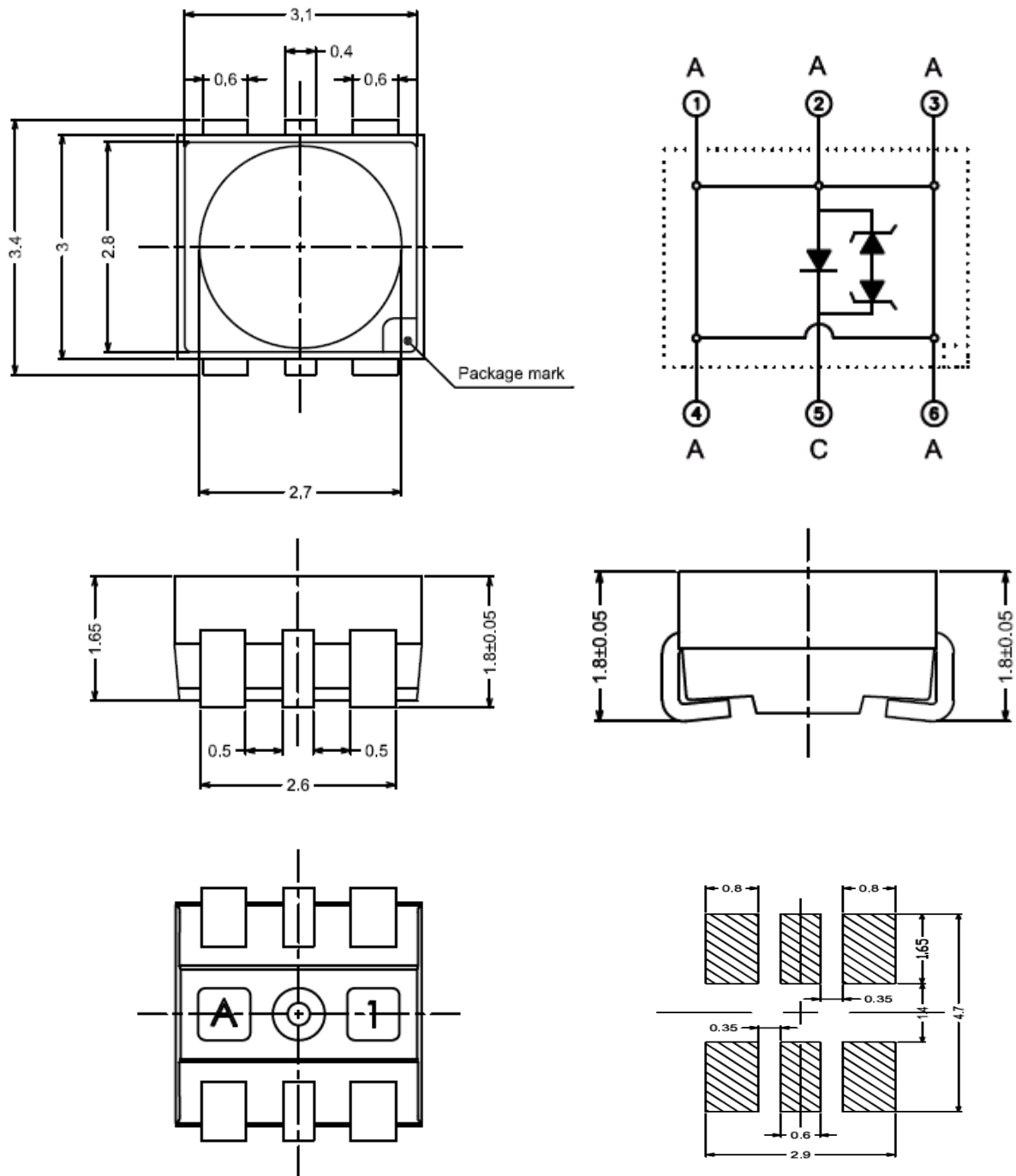

Note: Tolerances unless mentioned $\pm 0.25\text{mm}$. Unit = mm

Carrier Tape Dimensions Loaded Quantity 1000 pcs Per Reel

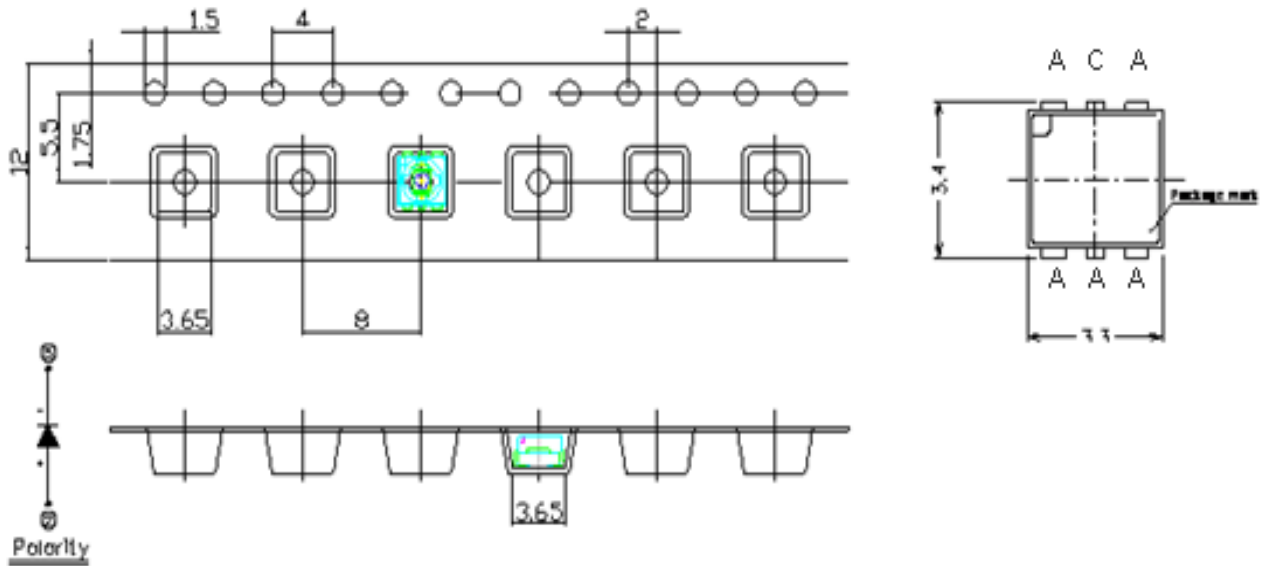

Note: Tolerances unless mentioned ± 0.1 mm. Unit = mm

Label Explanation

• CPN: Customer's Product Number
• P/N: Product Number
• QTY: Packing Quantity
• CAT: Luminous Intensity Rank
• HUE: Dom. Wavelength Rank
• REF: Forward Voltage Rank
• LOT No: Lot Number



EVERLIGHT



CPN :
P/N : XXXXXXXXXXXXX
XXXXXXXXXXXXXX

QTY : XXX
XXXXXXXXXXXXXX

CAT : XXX
HUE : XXX
REF : XXX

LOT NO : XXXXXXXXX
XXXXXXXXXXXXXX

Reference : XXXXXXXX
XXXXXXXXXXXXXX

MADE IN TAIWAN

Reel Dimensions

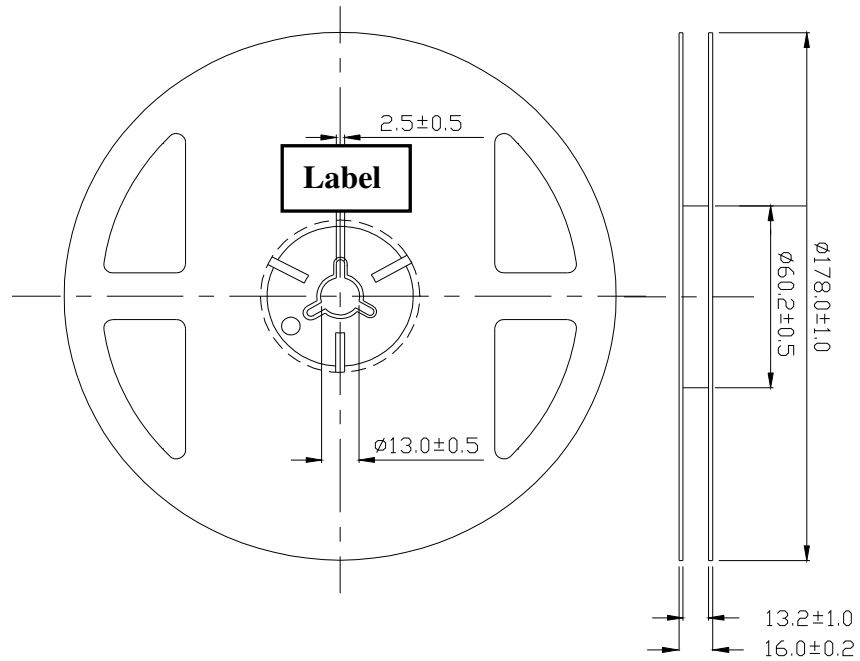

Note: Unit = mm

Moisture Resistant Packing Process

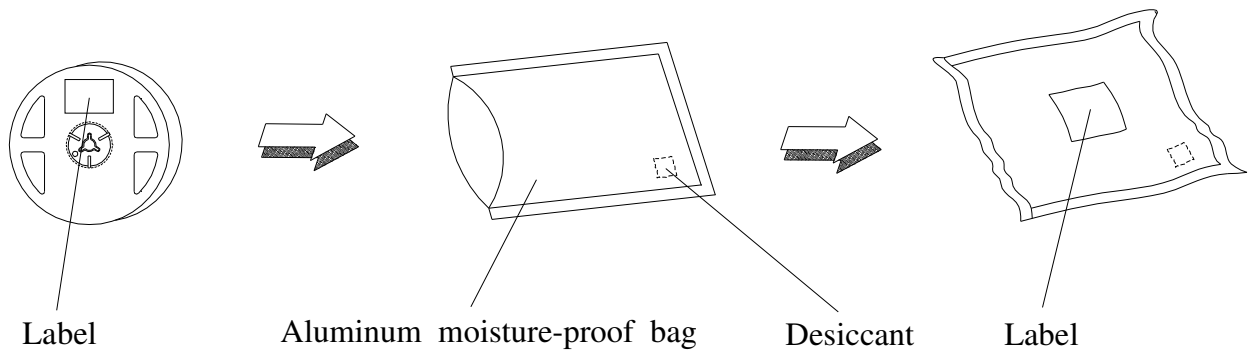

Precautions for Using

1. Soldering Condition (Reference: IPC/JEDEC J-STD-020D)

a. IR Reflow

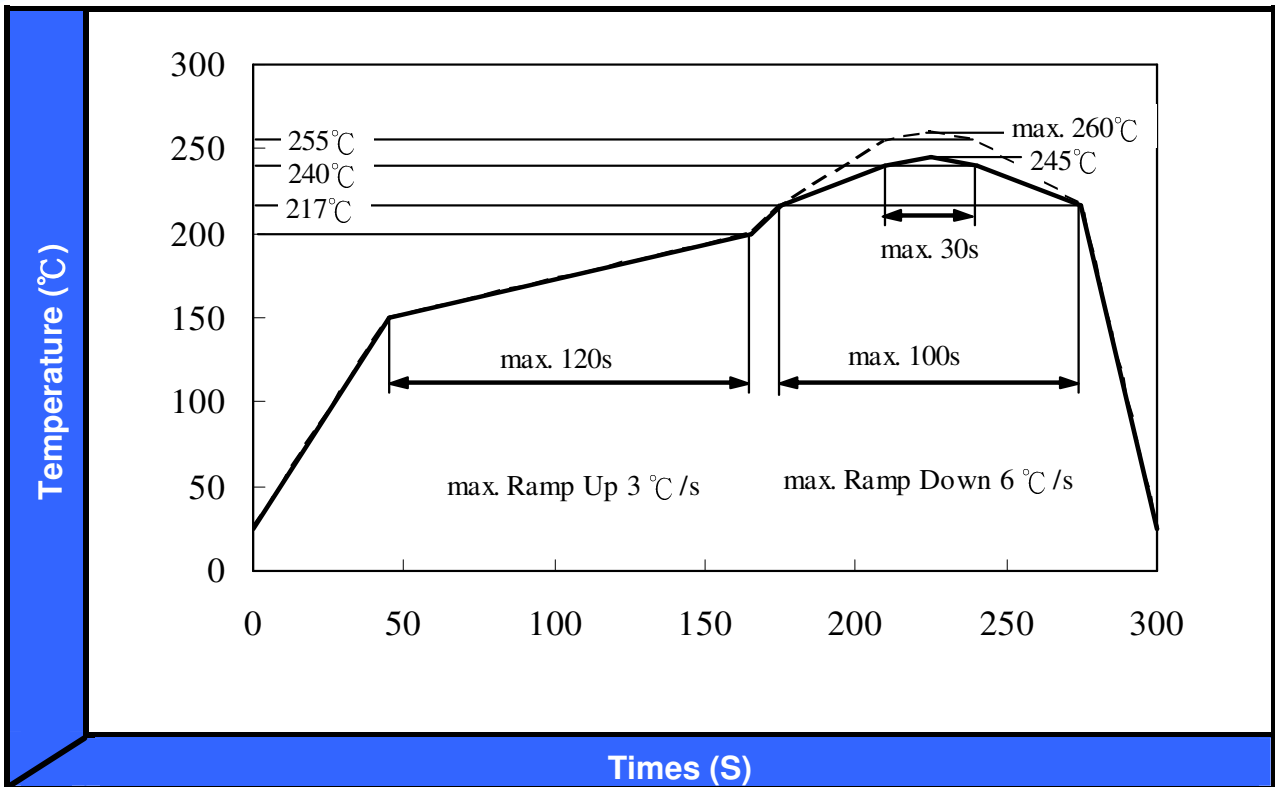

b. Wave Soldering Reflow

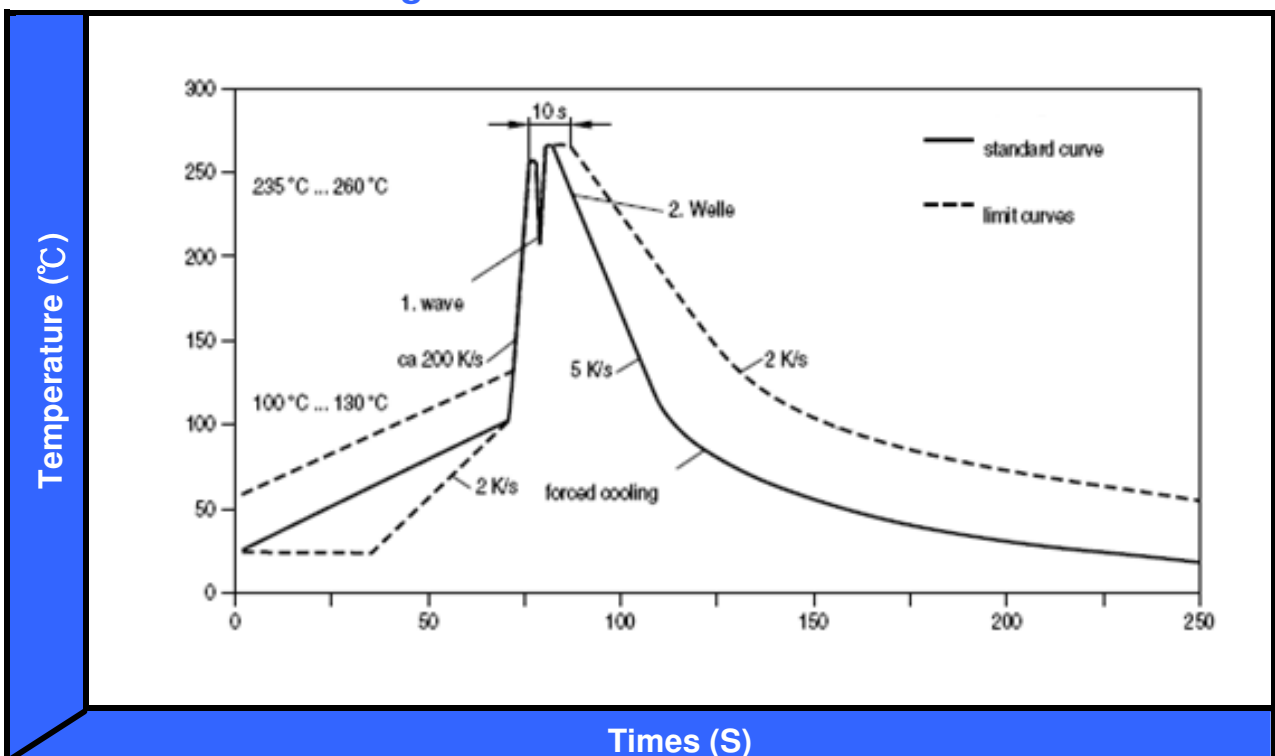

2. Current Limiting

Though A09K has conducted ESD protection mechanism, customers must not use the device in reverse and should apply resistors for extra protection. Otherwise, slight voltage difference may cause enormous current shift and burn out failure would happen.

3. Storage

3.1 Moisture proof bag should only be opened immediately prior to usage.

3.2 Environment should be less than 30 °C and 60 % RH when moisture proof bag is opened.

3.3 If the moisture sensitivity card indicates higher than acceptable moisture, the component should be baked at min. 60 deg +/-5 deg for 24 hours.

4. Thermal Management

4.1 For maintaining the high flux output and achieving reliability, A09K series LEDs should be mounted on a metal core printed circuit board (MCPCB) or other kinds of heat sink with proper thermal connection to dissipate approximate 0.5 W of thermal energy at 150 mA operation.

4.2 Sufficient thermal management must be implemented. Otherwise, the junction temperature of dies might be over the limit at high current driving condition and LEDs' lifetime might be decreases dramatically.

5. Iron Soldering

Hand soldering is not recommended for regular production. These guidelines are for rework only. Soldering iron tip should contact each terminal no more than 3 sec at 350 °C, using soldering iron with nominal power less than 25 W. Allow min. 2 sec. between soldering intervals.

6. Usage

Do not exceed the values given in this specification.

Application Restrictions

High reliability applications such as military/aerospace, automotive safety/security systems, and medical equipment may require different product. If you have any concerns, please contact Everlight before using this product in your application. This specification guarantees the quality and performance of the product as an individual component. Do not use this product beyond the specification described in this document.

Revision History

Rev.	Modified date	File modified contents
1	2010/05/10	New Spec