

ASMT-Jx1x

1W Mini Power LED Light Source



Data Sheet



Lead (Pb) Free
RoHS 6 fully
compliant



Description

This 1W Mini Power LED Light Source is a high performance energy efficient device which can handle high thermal and high driving current. Option with electrically isolated metal slug is also available.

The White Mini Power LED is available in the range of color temperature from 2700K to 10000K.

The low profile package design and ultra small footprint is suitable for a wide variety of applications especially where space and height is a constraint.

The package is compatible with reflow soldering process. To facilitate easy pick & place assembly, the LEDs are packed in EIA-compliant tape and reel.

Features

- Available in Red, Red Orange, Amber, Blue, Royal Blue, Cyan, Green, Cool White, Neutral White and Warm White color
- Small footprint
- Energy efficient
- Direct heat transfer from metal slug to mother board
- Compatible with reflow soldering process
- High current operation
- Long operation life
- Wide viewing angle
- Silicone encapsulation
- Non-ESD sensitive (threshold > 16kV)
- MSL 1 products

Applications

- Architectural lighting
- Garden lighting
- Decorative lighting
- Sign backlight
- Safety, exit and emergency sign lightings
- Specialty lighting such as task lighting and reading lights
- Retail display
- Commercial lighting
- Accent or marker lightings, strip or step lightings
- Portable lightings, bicycle head lamp, torch lights.
- Pathway lighting
- Street lighting
- Tunnel lighting

CAUTION: Customer is advised to keep the LEDs in the MBB when not in use as prolonged exposure to environment might cause the silver plated leads to tarnish, which might cause difficulties in soldering.

Package Dimensions

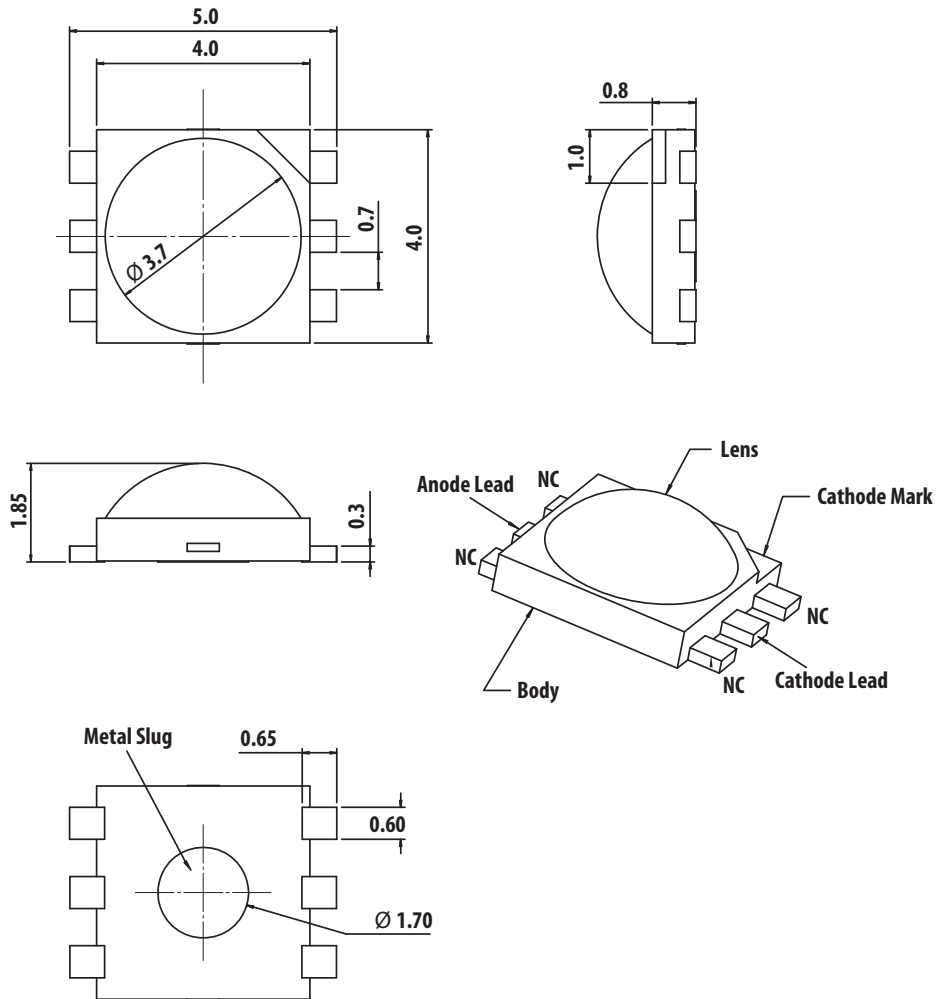
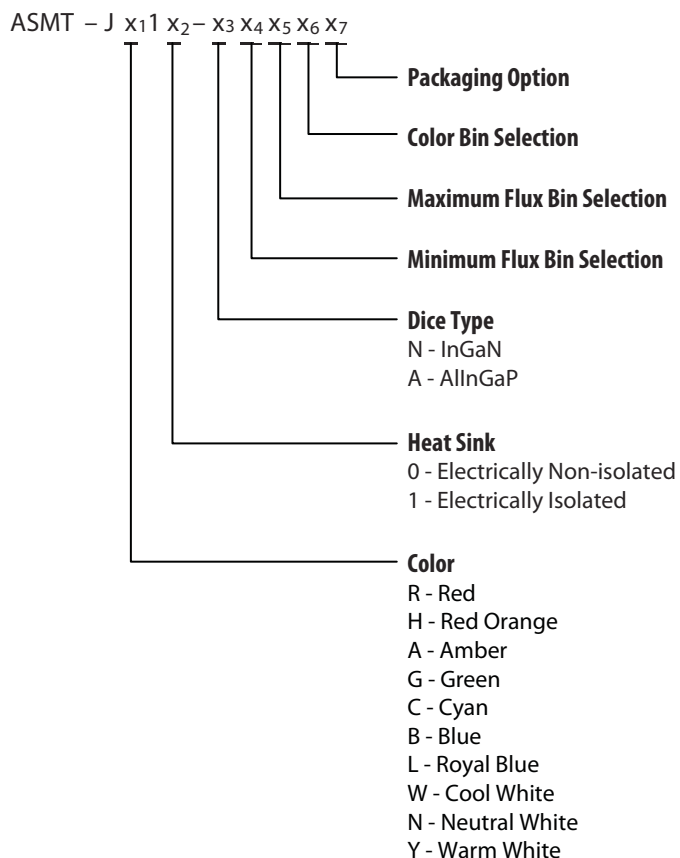

Figure 1. ASMT-Jx1x package outline drawing

Notes:

1. All dimensions in millimeters.
2. Metal slug is connected to anode for electrically non-isolated option.
3. Tolerance is ± 0.1 mm unless otherwise specified.
4. Terminal finish: Ag plating.
5. Corresponding NC (No Connection) leads adjacent to anode and cathode leads can be electrically short.

Part Numbering System



Note:

1. Please refer to Page 9 for selection details.

Device Selection Guide ($T_J = 25^\circ\text{C}$)

Part Number	Color	Luminous Flux (lm) / Radiometric Power (mW), $\Phi_V^{[1,2]}$			Test Current (mA)	Dice Technology	Electrically Isolated Metal Slug
		Min.	Typ.	Max.			
ASMT-JR10-ARS01	Red	39.8	48.0	67.2	350	AllnGaP	No
ASMT-JR10-AST01		51.7	62.0	87.4			
ASMT-JA10-ARS01	Amber	39.8	48.0	67.2	350	AllnGaP	No
ASMT-JH10-ARS01	Red Orange	39.8	48.0	67.2	350	AllnGaP	No
ASMT-JB11-NMP01	Blue	13.9	18.0	30.6	350	InGaN	Yes
ASMT-JB11-NNQ01	Blue	18.1	24.0	39.8	350	InGaN	Yes
ASMT-JL11-NMP01	Royal Blue	225 mW	350 mW	435 mW	350	InGaN	Yes
ASMT-JL11-NNQ01	Royal Blue	275mW	355mW	515mW	350	InGaN	Yes
ASMT-JC11-NST01	Cyan	51.7	58	87.4	350	InGaN	Yes
ASMT-JG11-NST01	Green	51.7	70.0	87.4	350	InGaN	Yes
ASMT-JW11-NUW01	Cool White	87.4	106.0	129.5	350	InGaN	Yes
ASMT-JN11-NUW01	Neutral White	87.4	106.0	129.5	350	InGaN	Yes
ASMT-JY11-NTV01	Warm White	67.2	87.0	113.6	350	InGaN	Yes

Notes:

1. Φ_V is the total luminous flux / radiometric power output as measured with an integrating sphere at 25ms mono pulse condition.
2. Flux tolerance is $\pm 10\%$

Absolute Maximum Ratings

Parameter	AllInGaP	InGaN	InGaN Cyan	Units
DC Forward Current ^[1]	500	500	500	mA
Peak Pulsing Current ^[2]	1000	1000	1000	mA
Power Dissipation	1230	1830	1980	mW
LED Junction Temperature	125	150	150	°C
Operating Metal Slug Temperature Range at 350 mA	-40 to +115	-40 to +135	-40 to +135	°C
Storage Temperature Range	-40 to +120	-40 to +120	-40 to +120	°C
Soldering Temperature	Refer to Figure 26			
Reverse Voltage ^[3]	Not recommended			

Notes:

1. Derate linearly based on Figure 10 for AllInGaP and Figure 22 for InGaN.
2. Pulse condition duty factor = 10%, Frequency = 1 kHz.
3. Not designed for reverse bias operation

Optical Characteristics at 350 mA (T_J = 25 °C)

Part Number	Color	Peak Wavelength, λ_{PEAK} (nm)	Dominant Wavelength, λ_D ^[1] (nm)	Viewing Angle, $2\theta_{1/2}$ ^[2] (°)	Luminous Efficiency (lm/W)
		Typ.	Typ.	Typ.	Typ.
ASMT-JR10-ARS01	Red	635	625	165	65
ASMT-JR10-AST01		635	625	165	84
ASMT-JA10-ARS01	Amber	598	590	165	65
ASMT-JH10-ARS01	Red Orange	625	615	165	65
ASMT-JG11-NST01	Green	519	525	165	63
ASMT-JC11-NST01	Cyan	497	500	165	49
ASMT-JB11-NMP01	Blue	454	460	165	16
ASMT-JB11-NNQ01	Blue	454	460	165	21
ASMT-JL11-NMP01	Royal Blue	450	455	165	Not applicable
ASMT-JL11-NNQ01	Royal Blue	450	455	165	Not Applicable

Part Number	Color	Correlated Color Temperature, CCT (Kelvin)		Viewing Angle, $2\theta_{1/2}$ ^[2] (°)	Luminous Efficiency (lm/W)
		Min.	Max.	Typ.	Typ.
ASMT-JW11-NUW01	Cool White	4500	10000	140	95
ASMT-JN11-NUW01	Warm White	3500	4500	140	95
ASMT-JY11-NTV01	Warm White	2700	3500	140	78

Notes:

1. The dominant wavelength, λ_D , is derived from the CIE Chromaticity Diagram and represents the color of the device.
2. $\theta_{1/2}$ is the off-axis angle where the luminous intensity is 1/2 the peak intensity.

Electrical Characteristic at 350 mA (T_J = 25°C)

Dice Type	Forward Voltage, V _F (Volts)			Thermal Resistance, R _{θj-ms} (°C/W) ^[1]
	Min.	Typ.	Max.	Typ.
AllInGaP	1.7	2.1	2.3	9
InGaN (non-Cyan colors)	2.8	3.2	3.5	9
InGaN Cyan	3.0	3.4	3.8	9

Note:

1. R_{θj-ms} is Thermal Resistance from LED junction to metal slug.

AlInGaP

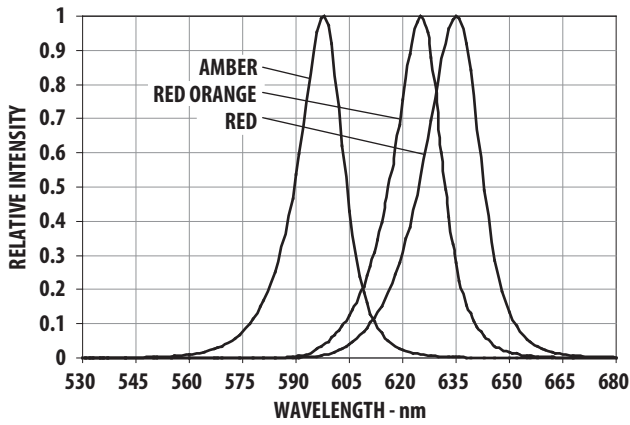

Figure 2. Relative Intensity vs. Wavelength for Red, Red-Orange and Amber

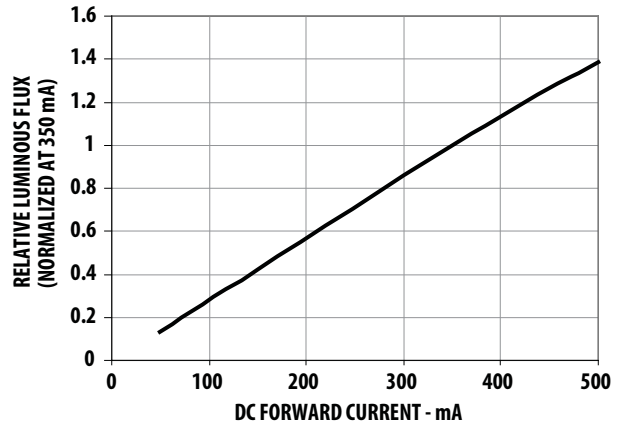

Figure 3. Relative Luminous Flux vs. Mono Pulse Current

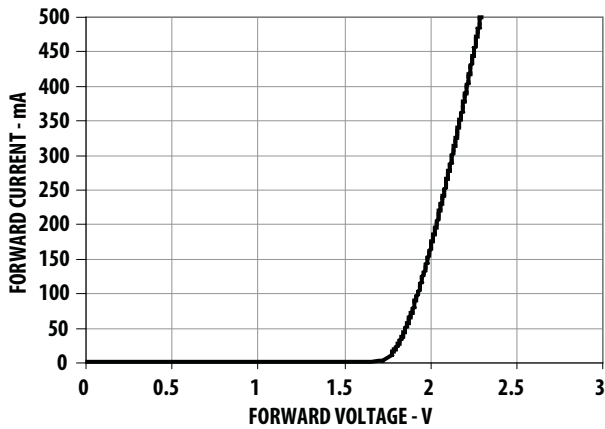

Figure 4. Forward Current vs. Forward Voltage

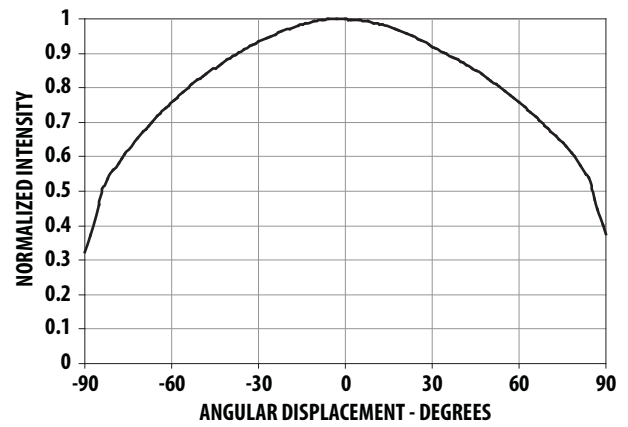

Figure 5. Radiation Pattern for Red, Red Orange and Amber

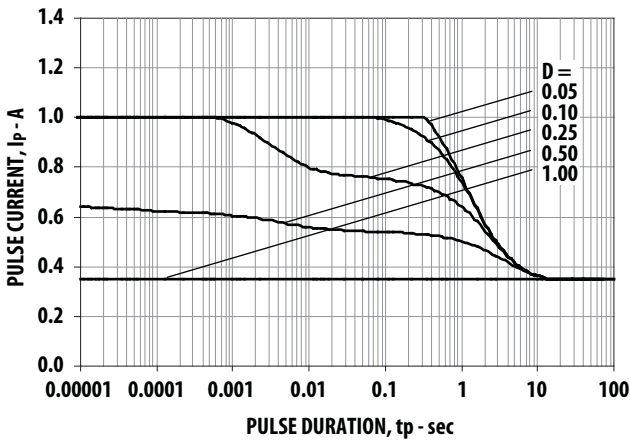

Figure 6. Maximum pulse current vs. ambient temperature. Derated based on $T_A = 25^\circ\text{C}$, $R\theta_{J-A} = 50^\circ\text{C/W}$.

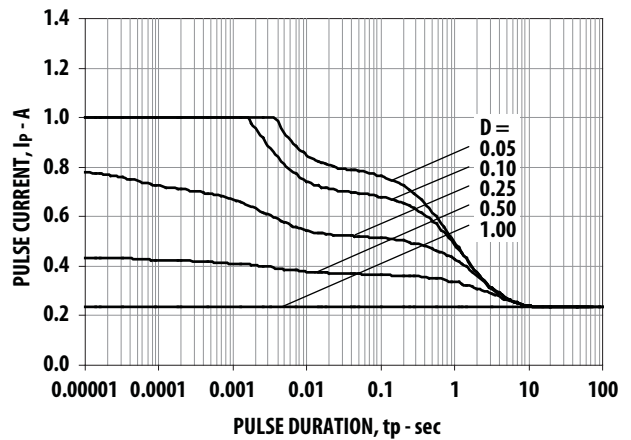

Figure 7. Maximum pulse current vs. ambient temperature. Derated based on $T_A = 85^\circ\text{C}$, $R\theta_{J-A} = 50^\circ\text{C/W}$.

AllnGaP

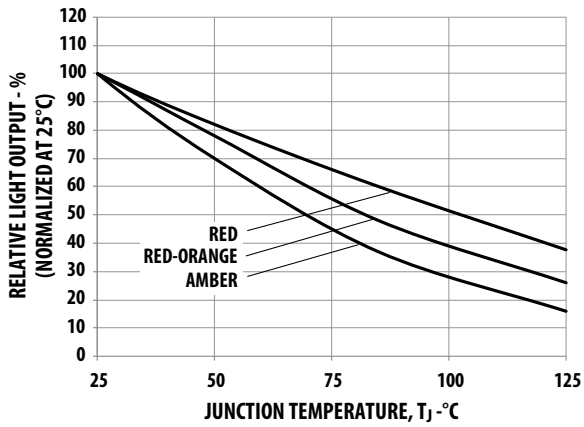

Figure 8. Relative Light Output vs. Junction Temperature

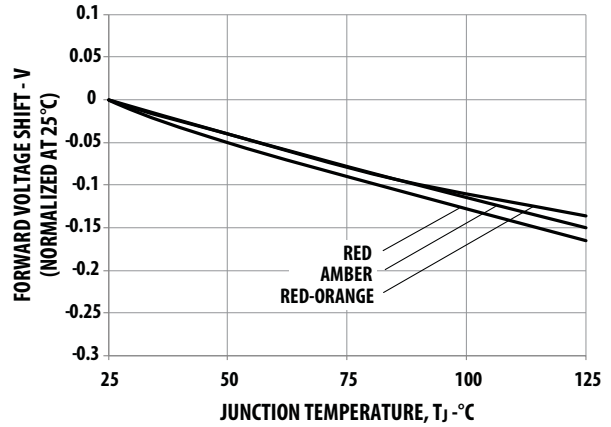

Figure 9. Forward Voltage Shift vs. Junction Temperature

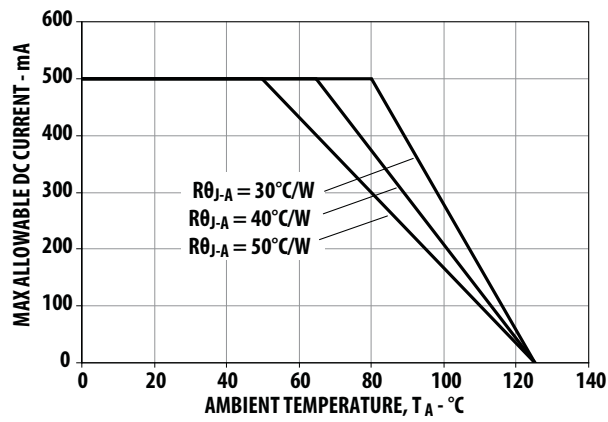

Figure 10. Maximum Forward Current vs. Ambient Temperature. Derated based on T_{JMAX} = 125°C, R_{θJ-A} = 30°C/W, 40°C/W and 50°C/W

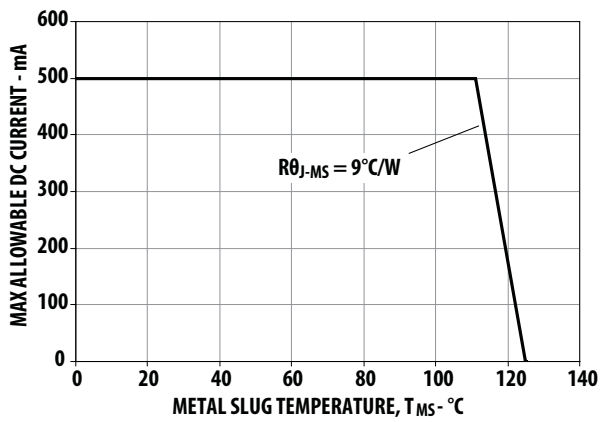

Figure 11. Maximum Forward Current vs. Ambient Slug Temperature. Derated based on T_{JMAX} = 125°C, R_{θJ-MS} = 9°C/W

InGaN

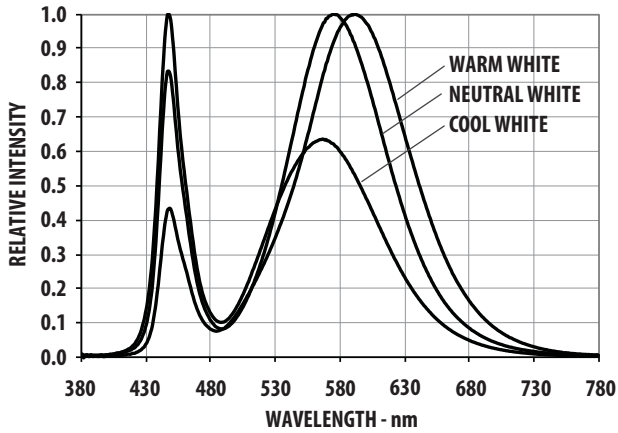

Figure 12. Relative Intensity vs. Wavelength for Cool, Neutral and Warm White

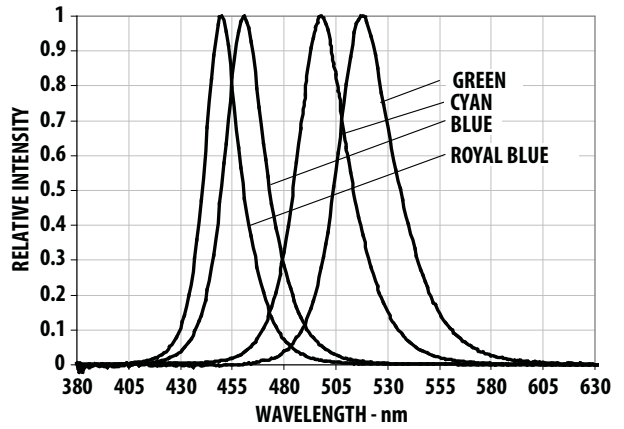

Figure 13. Relative Intensity vs. Wavelength for Blue, Royal Blue, Cyan and Green

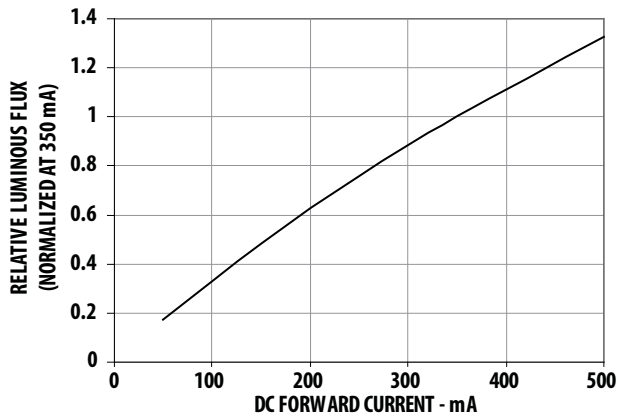

Figure 14. Relative Luminous Flux vs. Mono Pulse Current

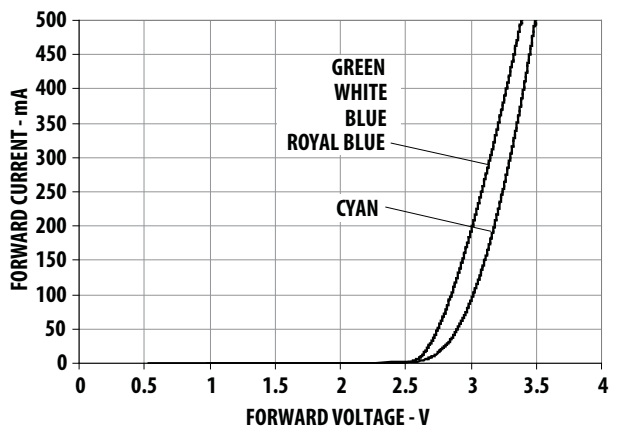

Figure 15. Forward Current vs. Forward Voltage

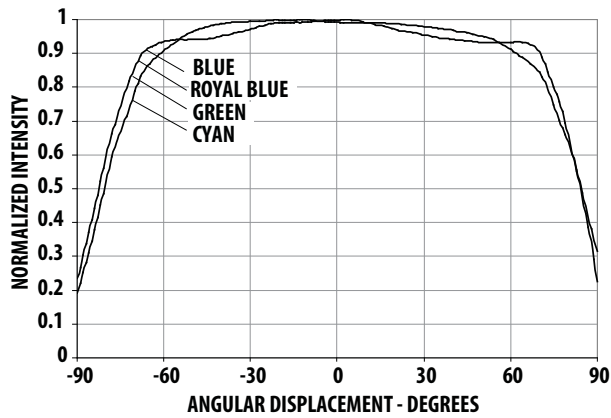

Figure 16. Radiation Pattern for Blue, Royal Blue, Cyan and Green

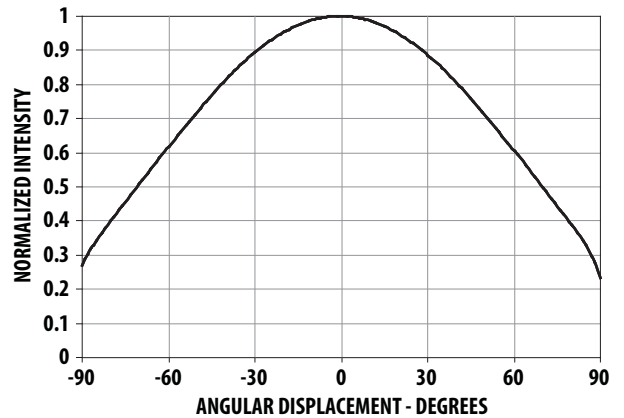

Figure 17. Radiation Pattern for Cool White, Neutral White and Warm White

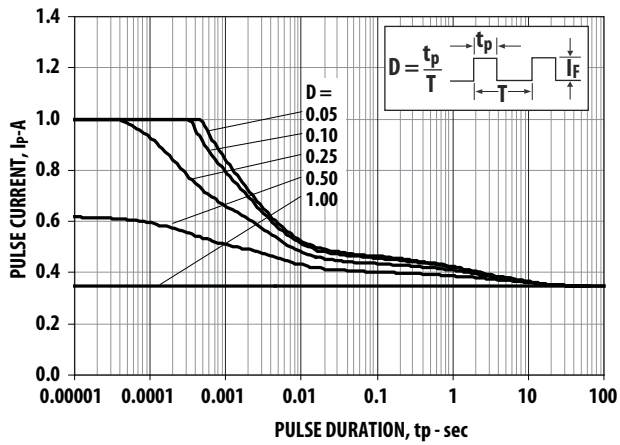

Figure 18. Maximum pulse current vs. ambient temperature. Derated based on $T_A = 25^\circ\text{C}$, $R_{\theta J-A} = 50^\circ\text{C/W}$.

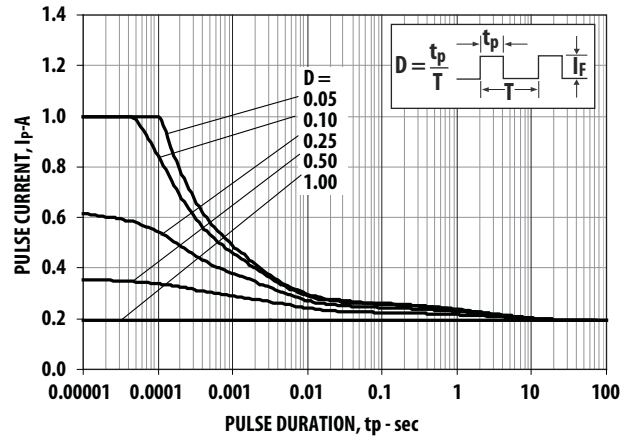

Figure 19. Maximum pulse current vs. ambient temperature. Derated based on $T_A = 85^\circ\text{C}$, $R_{\theta J-A} = 50^\circ\text{C/W}$.

InGaN

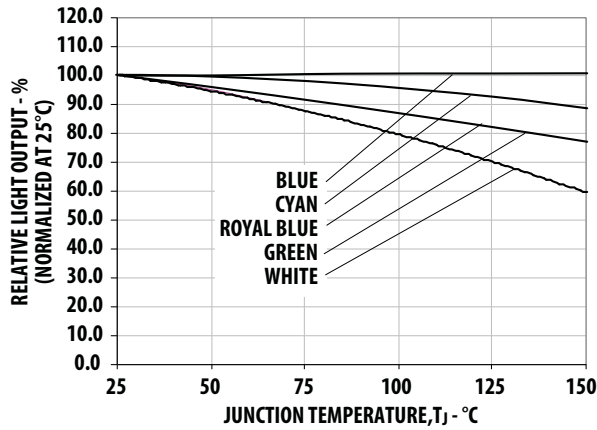

Figure 20. Relative Light Output vs. Junction Temperature

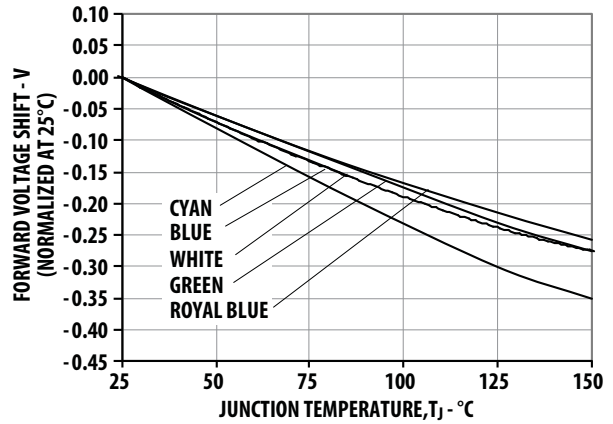

Figure 21. Forward Voltage Shift vs. Junction Temperature

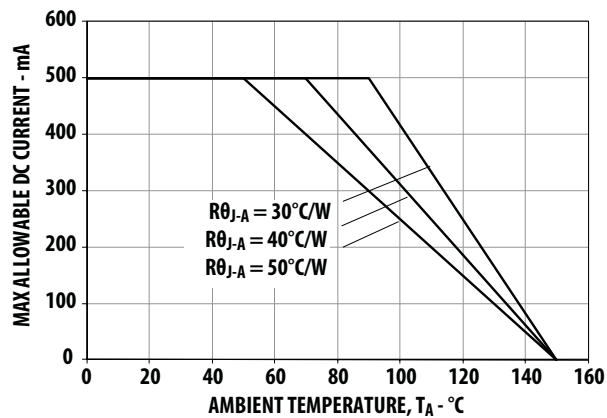

Figure 22. Maximum Forward Current vs. Ambient Temperature. Derated based on $T_{JMAX} = 150^\circ\text{C}$, $R_{\theta J-A} = 30^\circ\text{C/W}$, 40°C/W and 50°C/W

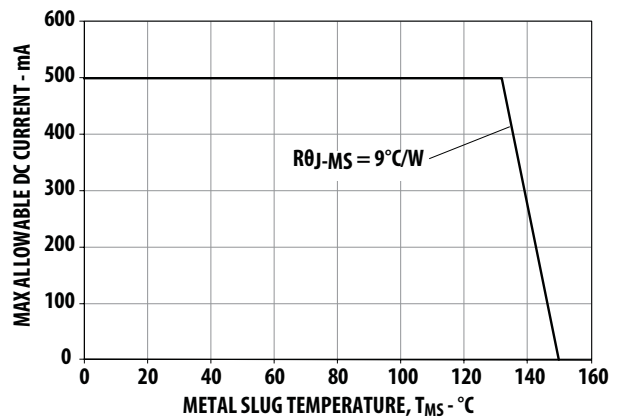

Figure 23. Maximum Forward Current vs. Metal Slug Temperature. Derated based on $T_{JMAX} = 150^\circ\text{C}$, $R_{\theta J-MS} = 9^\circ\text{C/W}$.

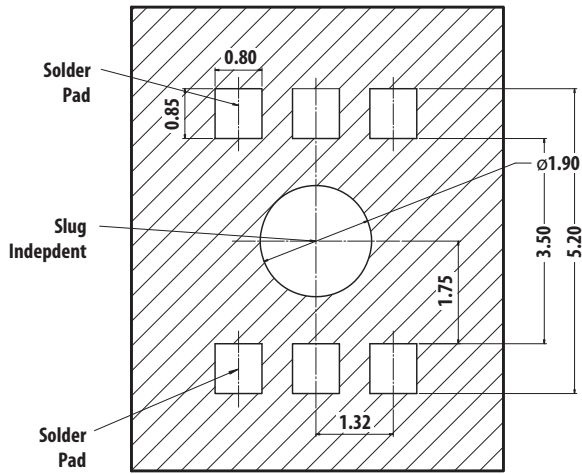

Figure 24. Recommended soldering land pattern

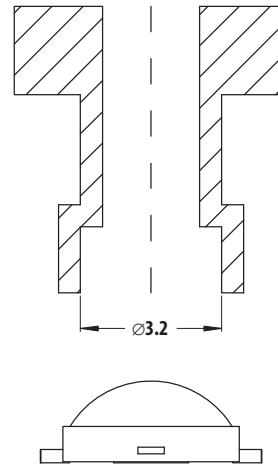

Figure 25. Recommended pick and place nozzle tip.
Inner diameter = 3.2 mm.

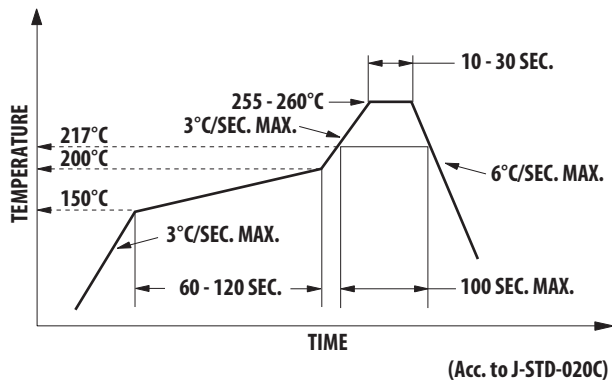

Figure 26. Recommended Reflow Soldering Profile

Note: For detail information on reflow soldering of Avago surface mount LEDs, do refer to Avago Application Note AN 1060 Surface Mounting SMT LED Indicator Components.

Option Selection Details

ASMT-J x₁ 1 x₂ - x₃ x₄ x₅ x₆ x₇

x₄ - Minimum Flux Bin Selection

x₅ - Maximum Flux Bin Selection

x₆ - Color Bin Selection

x₇ - Packaging Option

Flux / Power Bin Limit [x₄, x₅]

Color	Bin ID	Luminous Flux (lm) / Radiometric Power (mW) at 350 mA	
		Min.	Max.
Blue	M	13.9	18.1
	N	18.1	23.5
	P	23.5	30.6
	Q	30.6	39.8
Other Colors	R	39.8	51.7
	S	51.7	67.2
	T	67.2	87.4
	U	87.4	99.6
	V	99.6	113.6
	W	113.6	129.5
Royal Blue	M	225.0	275.0
	N	275.0	355.0
	P	355.0	435.0
	Q	435.0	515.0

Tolerance for each bin limits is ±10%

Color Bin Selection [x₄]

Individual reel will contain parts from one color bin selection only.

Cool White

Selection	Bin ID
0	Full Distribution
E	VM, UM, VN and UN
F	WM, VM, WN and VN
G	XM, WM, XN and WN
H	UN, VN, U0 and V0
J	WN, VN, W0 and V0
K	XN, WN, X0 and W0
L	V0, U0, VP and UP
M	W0, V0, WP, VP and WQ
N	X0, W0, XP, WP and WQ
P	Y0
Q	YA

Neutral White

Selection	Bin ID
0	Full Distribution
E	SM, RM, S1 and R1
F	TM, SM, TN and S1
G	S1, R1, S0 and R0
H	TN, S1, T0 and S0
J	S0, R0, SA and RA
K	T0, S0, TP and SA

Warm White

Selection	Bin ID
0	Full Distribution
E	NM, MM, N1 and M1
F	PM, NM, P1 and N1
G	QM, PM, Q1 and P1
H	M1, N1, M0 and N0
J	P1, N1, P0 and N0
K	Q1, P1, Q0 and P0
L	N0, M0, NA and MA
M	P0, N0, PA and NA
N	Q0, P0, QA and PA

Others Colors

Selection	Bin ID
0	Full Distribution
Z	A and B
Y	B and C
W	C and D
V	D and E
Q	A, B and C
P	B, C and D
N	C, D and E
M	D, E and F

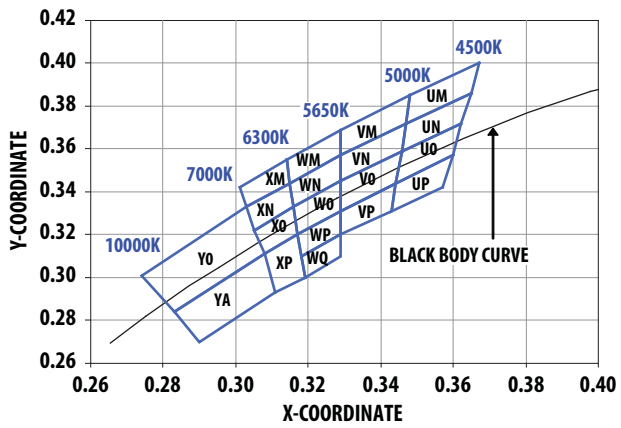

Figure 27. Color bin Structure for Cool White

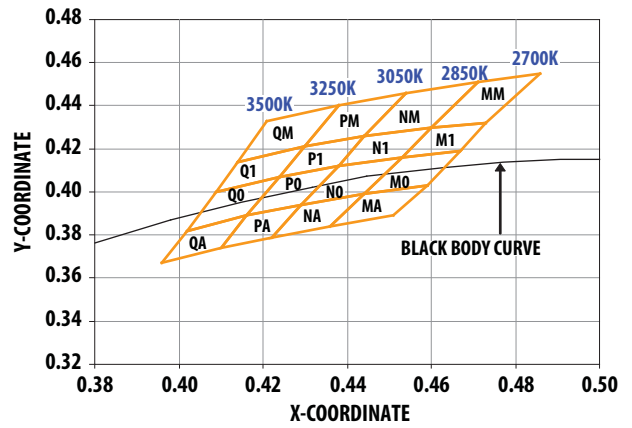

Figure 28. Color bin structure for Warm White

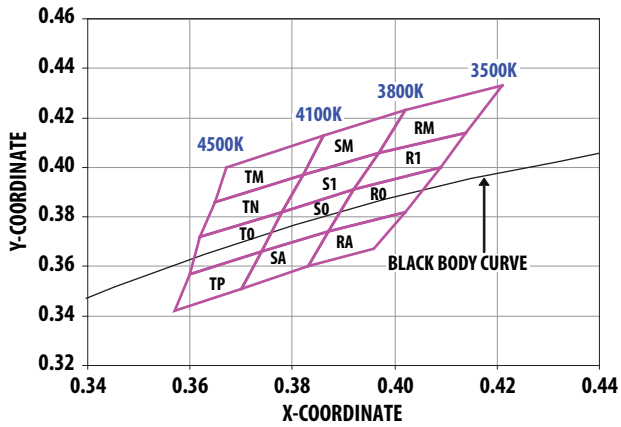

Figure 29. Color bin structure for Neutral White

Color Bin Limits

Cool White	Color Limits (Chromaticity Coordinates)				
		x	y		
Bin UM	x	0.365	0.348	0.347	0.367
	y	0.386	0.385	0.372	0.400
Bin UN	x	0.365	0.362	0.346	0.347
	y	0.386	0.372	0.359	0.372
Bin UO	x	0.362	0.360	0.344	0.346
	y	0.372	0.357	0.344	0.359
Bin UP	x	0.360	0.357	0.343	0.344
	y	0.357	0.342	0.331	0.344
Bin VM	x	0.329	0.329	0.348	0.347
	y	0.357	0.369	0.385	0.372
Bin VN	x	0.329	0.329	0.347	0.346
	y	0.345	0.357	0.372	0.359
Bin VO	x	0.329	0.329	0.346	0.344
	y	0.331	0.345	0.359	0.344
Bin VP	x	0.329	0.344	0.343	0.329
	y	0.331	0.344	0.331	0.320
Bin WM	x	0.329	0.329	0.315	0.314
	y	0.369	0.357	0.344	0.355
Bin WN	x	0.329	0.316	0.315	0.329
	y	0.345	0.333	0.344	0.357
Bin W0	x	0.329	0.329	0.317	0.316
	y	0.345	0.331	0.320	0.333
Bin WP	x	0.329	0.329	0.318	0.317
	y	0.331	0.320	0.310	0.320
Bin WQ	x	0.329	0.329	0.319	0.318
	y	0.320	0.310	0.300	0.310
Bin XM	x	0.301	0.314	0.315	0.303
	y	0.342	0.355	0.344	0.333
Bin XN	x	0.305	0.303	0.315	0.316
	y	0.322	0.333	0.344	0.333
Bin XO	x	0.308	0.305	0.316	0.317
	y	0.311	0.322	0.333	0.320
Bin XP	x	0.308	0.317	0.319	0.311
	y	0.311	0.320	0.300	0.293
Bin YO	x	0.308	0.283	0.274	0.303
	y	0.311	0.284	0.301	0.333
Bin YA	x	0.308	0.311	0.290	0.283
	y	0.311	0.293	0.270	0.284

Tolerance: ±0.01

Warm White	Color Limits (Chromaticity Coordinates)				
		x	y		
Bin MM	x	0.471	0.460	0.473	0.486
	y	0.451	0.430	0.432	0.455
Bin M1	x	0.460	0.453	0.467	0.473
	y	0.430	0.416	0.419	0.432
Bin M0	x	0.453	0.444	0.459	0.467
	y	0.416	0.399	0.403	0.419
Bin MA	x	0.459	0.444	0.436	0.451
	y	0.403	0.399	0.384	0.389
Bin NM	x	0.454	0.444	0.460	0.471
	y	0.446	0.426	0.430	0.451
Bin N1	x	0.444	0.438	0.453	0.460
	y	0.426	0.412	0.416	0.430
Bin N0	x	0.438	0.429	0.444	0.453
	y	0.412	0.394	0.399	0.416
Bin NA	x	0.444	0.429	0.422	0.436
	y	0.399	0.394	0.379	0.384
Bin PM	x	0.438	0.430	0.444	0.454
	y	0.440	0.421	0.426	0.446
Bin P1	x	0.430	0.424	0.438	0.444
	y	0.421	0.407	0.412	0.426
Bin P0	x	0.424	0.416	0.429	0.438
	y	0.407	0.389	0.394	0.412
Bin PA	x	0.429	0.416	0.410	0.422
	y	0.394	0.389	0.374	0.379
Bin QM	x	0.421	0.414	0.430	0.438
	y	0.433	0.414	0.421	0.440
Bin Q1	x	0.414	0.409	0.424	0.430
	y	0.414	0.400	0.407	0.421
Bin Q0	x	0.409	0.402	0.416	0.424
	y	0.400	0.382	0.389	0.407
Bin QA	x	0.416	0.402	0.396	0.410
	y	0.389	0.382	0.367	0.374

Tolerance: ±0.01

Neutral White	Color Limits (Chromaticity Coordinates)				
		x	y	z	u
Bin RM	x	0.421	0.414	0.397	0.402
	y	0.433	0.414	0.406	0.423
Bin R1	x	0.414	0.409	0.392	0.397
	y	0.414	0.400	0.391	0.406
Bin R0	x	0.392	0.387	0.402	0.409
	y	0.391	0.374	0.382	0.400
Bin RA	x	0.387	0.383	0.396	0.402
	y	0.374	0.360	0.367	0.382
Bin SM	x	0.402	0.397	0.382	0.386
	y	0.423	0.406	0.397	0.413
Bin S1	x	0.397	0.392	0.378	0.382
	y	0.406	0.391	0.382	0.397
Bin S0	x	0.392	0.387	0.374	0.378
	y	0.391	0.374	0.366	0.382
Bin SA	x	0.387	0.383	0.370	0.374
	y	0.374	0.360	0.351	0.366
Bin TM	x	0.386	0.382	0.365	0.367
	y	0.413	0.397	0.386	0.400
Bin TN	x	0.382	0.378	0.362	0.365
	y	0.397	0.382	0.372	0.386
Bin TO	x	0.378	0.374	0.360	0.362
	y	0.382	0.366	0.357	0.372
Bin TP	x	0.374	0.370	0.357	0.360
	y	0.366	0.351	0.342	0.357

Tolerance: ±0.01

Packaging Option [x₇]

Selection	Option
1	Tape and Reel

Example

ASMT-JY11-NST01

ASMT-JY11-Nxxxx – Warm White, InGaN,
Electrically isolated Heat Sink

- X₁ = S – Minimum Flux Bin S
- X₂ = T – Maximum Flux Bin T
- X₃ = 0 – Full Distribution
- X₄ = 1 – Tape and Reel Option

Color	Bin ID	Dominant Wavelength (nm) at 350 mA	
		Min.	Max.
Red	–	620.0	635.0
Red Orange	–	610.0	620.0
Amber	B	587.0	589.5
	C	589.5	592.0
	D	592.0	594.5
	E	594.5	597.0
Blue	A	455.0	460.0
	B	460.0	465.0
	C	465.0	470.0
	D	470.0	475.0
Cyan	C	490.0	495.0
	D	495.0	500.0
	E	500.0	505.0
	F	505.0	510.0
	G	510.0	515.0
	H	515.0	520.0
Green	A	515.0	520.0
	B	520.0	525.0
	C	525.0	530.0
	D	530.0	535.0

Tolerance: ± 1 nm

Color	Bin ID	Peak Wavelength (nm) at 350 mA	
		Min.	Max.
Royal Blue	C	440.0	445.0
	D	445.0	450.0
	E	450.0	455.0
	F	455.0	460.0

Tolerance: ±2 nm

Tape and Reel – Option 1

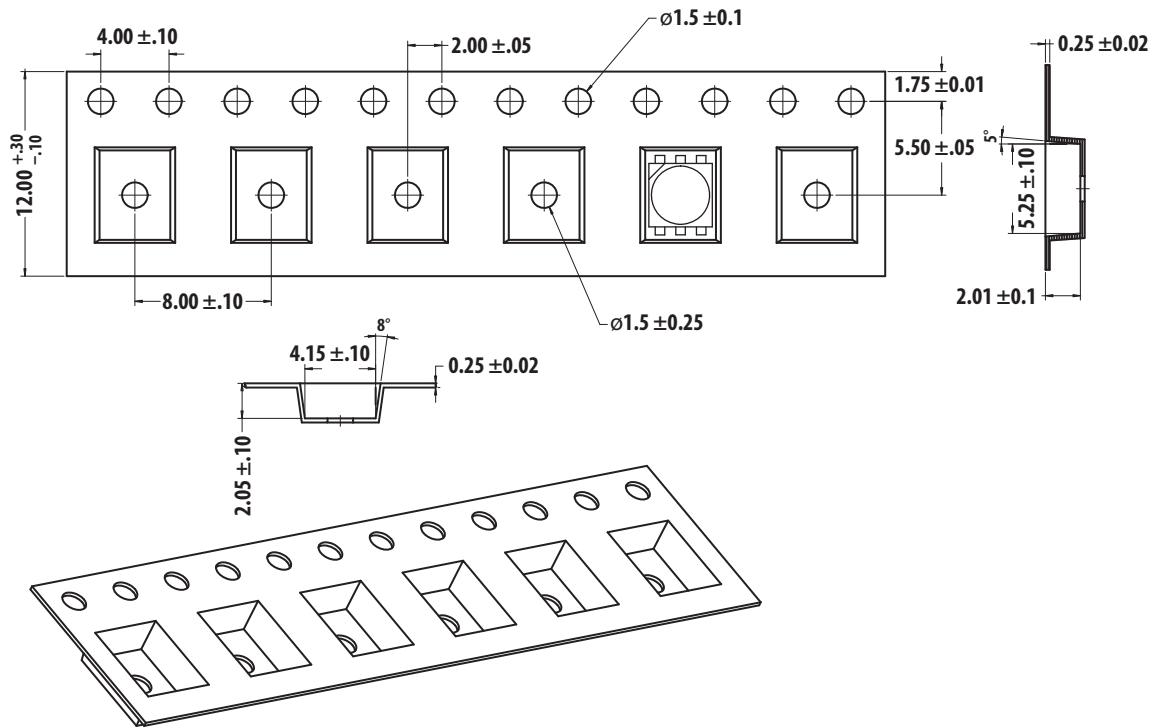
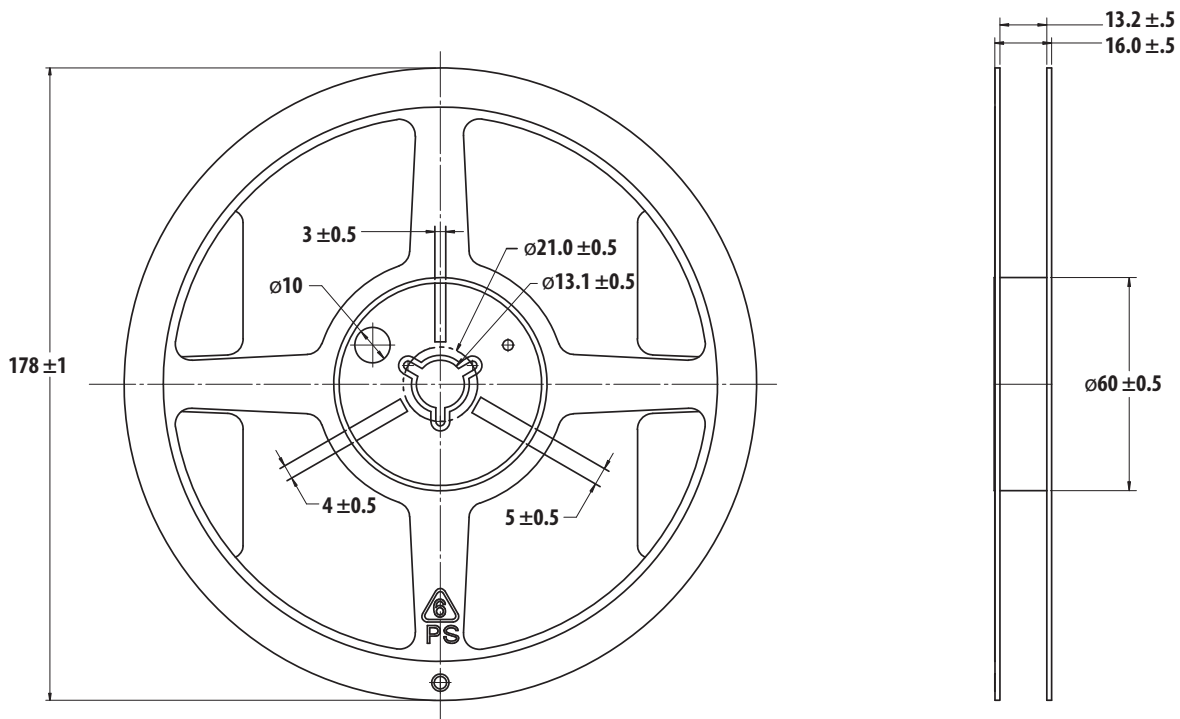

Figure 30. Carrier Tape Dimensions



Notes:

1. Empty component pockets sealed with top cover tape.
2. 250 or 500 pieces per reel.
3. Drawing not to scale.
4. All dimensions are in millimeters.

Figure 31. Reel dimensions

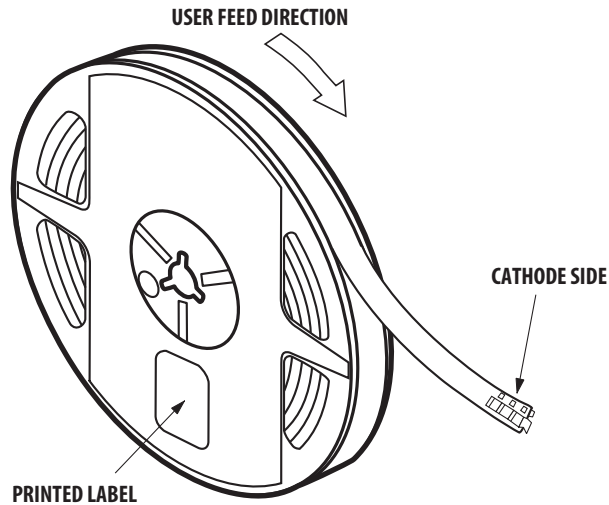

Figure 32. Reeling Orientation

DISCLAIMER: Avago's products and software are not specifically designed, manufactured or authorized for sale as parts, components or assemblies for the planning, construction, maintenance or direct operation of a nuclear facility or for use in medical devices or applications. Customer is solely responsible, and waives all rights to make claims against avago or its suppliers, for all loss, damage, expense or liability in connection with such use.

For product information and a complete list of distributors, please go to our web site: www.avagotech.com

Avago, Avago Technologies, and the A logo are trademarks of Avago Technologies in the United States and other countries. Data subject to change. Copyright © 2005-2012 Avago Technologies. All rights reserved.
AV02-1770EN - September 3, 2012

Avago
TECHNOLOGIES