



Technical Data Sheet

5.0mm 1pcs Circuit Board Indicator

A1479-1B/SURSYGW/S530-A3

Features :

- Low power consumption
- High efficiency and low cost
- Good control and free combinations on the colors of LED lamps
- Good lock and easy to assembly
- Stackable and easy to assembly
- Stackable vertically and easy to assembly
- Versatile mounting on P.C board or panel
- Stackable horizontally and easy to assembly
- Pb free
- The product itself will remain within RoHS compliant version.

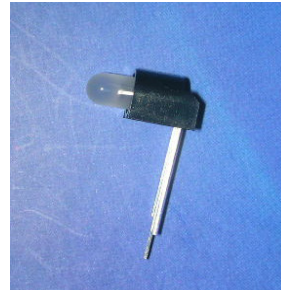

Descriptions :

- ARRAY=Plastic Holder+Combinations of Lamps
- The array will easily mount the applicable lamps on any panel up to

Applications :

- 1.Used as indicators of indicating the Degree, Functions, Positions etc, in electronic instruments.

PART NO.	Chip		Lens Color
	Material	Emitted Color	
339-1SURSYGW/S530-A3	AlGaInP	Hyper Red	White Diffused
	AlGaInP	Super Yellow Green	

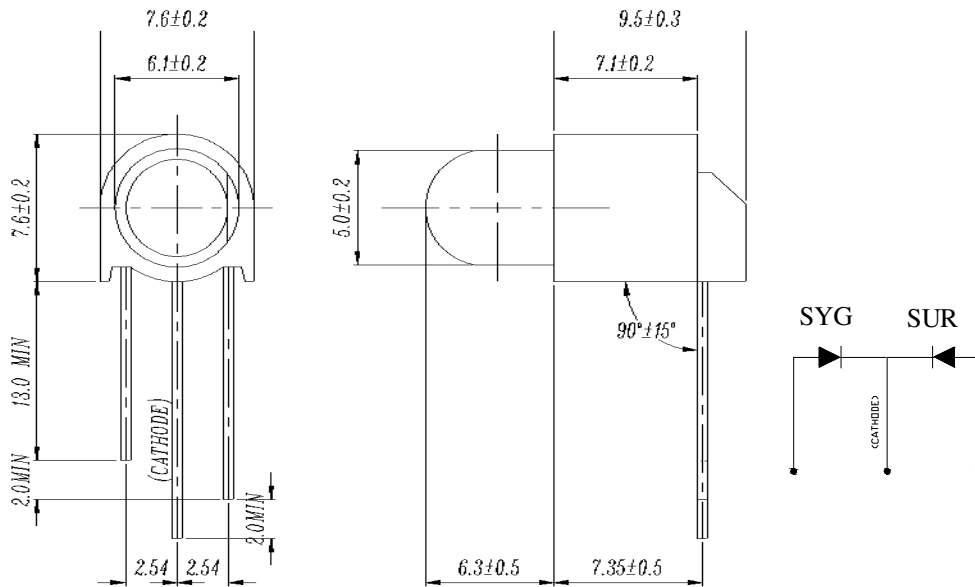
**Technical Data Sheet**
**5.0mm 1pcs Circuit Board Indicator**
**A1479-1B/SURSYGW/S530-A3**
**Package Dimensions**

- Notes:** 1.All dimensions are in millimeters, tolerance is 0.25mm except being specified  
 2.Lead spacing is measured where the lead emerge from the package

**Absolute Maximum Ratings at Ta = 25°C**

Parameter	Symbol	Rating	Unit	
Forward Current	IF	SUR/S530	25	mA
		SYG/S530	25	
Operating Temperature	Topr	-40 to +85	°C	
Storage Temperature	Tstg	-40 to +100	°C	
Soldering Temperature	Tsol	260 ± 5	°C	
Electrostatic Discharge	ESD	SUR/S530	2000	V
		SYG/S530	2000	
Power Dissipation	Pd	SUR/S530	60	mW
		SYG/S530	60	
Reverse Voltage	VR	5	V	

Note: \*1:IFP Conditions --Pulse Width ≤ 1msec and Duty ≤ 1/10.

\*2:Soldering time ≤ 5 seconds.



## Technical Data Sheet

## 5.0mm 1pcs Circuit Board Indicator

**A1479-1B/SURSYGW/S530-A3****Electro-Optical Characteristics (Ta=25°C)**

Parameter	Symbol		Min	Typ	Max	Unit	Condition
Luminous	I <sub>v</sub>	SUR/S530	25	50	/	mcd	I <sub>F</sub> = 20 mA
		SYG/S530	16	32	/		
Viewing Angle	2θ 1/2		/	100	/	deg	I <sub>F</sub> = 20 mA
Peak Wavelength	λ <sub>p</sub>	SUR/S530	/	632	/	nm	I <sub>F</sub> = 20 mA
		SYG/S530	/	575	/		
Dominant Wavelength	λ <sub>d</sub>	SUR/S530	/	624	/	nm	I <sub>F</sub> = 20 mA
		SYG/S530	/	573	/		
Spectrum Radiation Bandwidth	△λ	SUR/S530	/	20	/	nm	I <sub>F</sub> = 20 mA
		SYG/S530	/	20	/		
Forward Voltage	V <sub>F</sub>	SUR/S530	/	2.0	2.4	V	I <sub>F</sub> = 20 mA
		SYG/S530	/	2.0	2.4		
Reverse Current	I <sub>R</sub>	SUR/S530	/	/	10	μ A	V <sub>R</sub> = 5 V
		SYG/S530	/	/	10	μ A	

Technical Data Sheet

5.0mm 1pcs Circuit Board Indicator

**A1479-1B/SURSYGW/S530-A3**

■ Typical Electro-Optical Characteristic Curves:

( SUR )

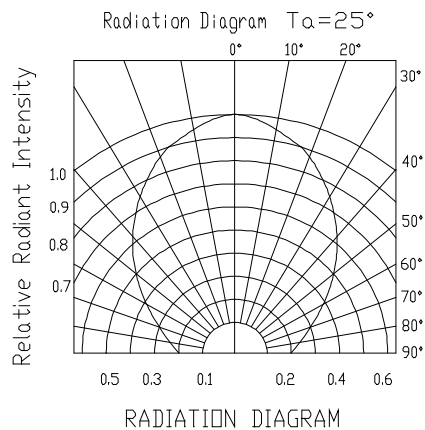
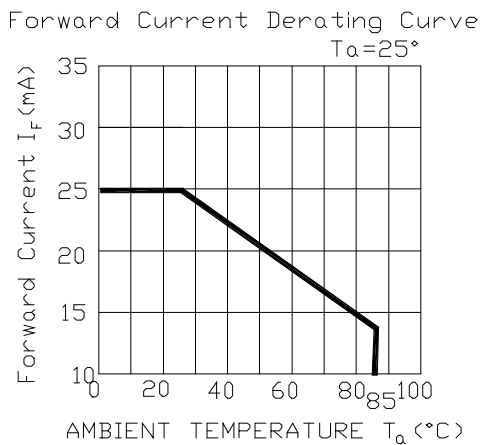
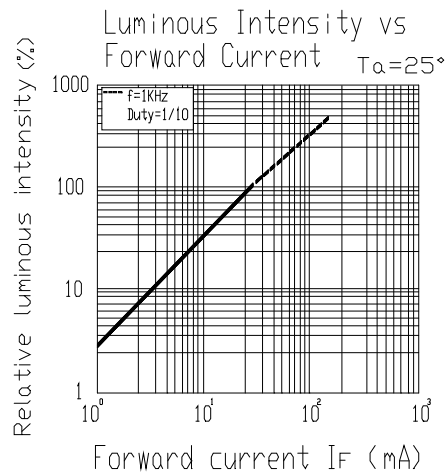
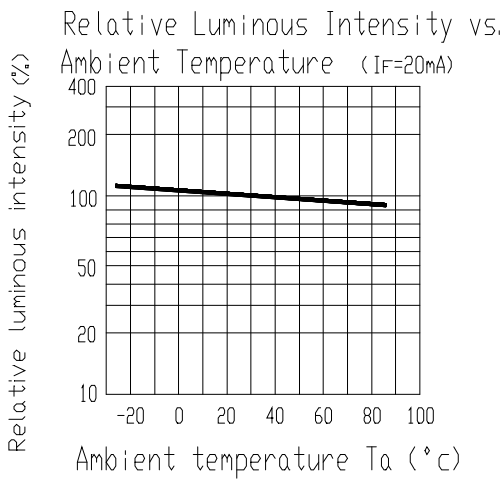
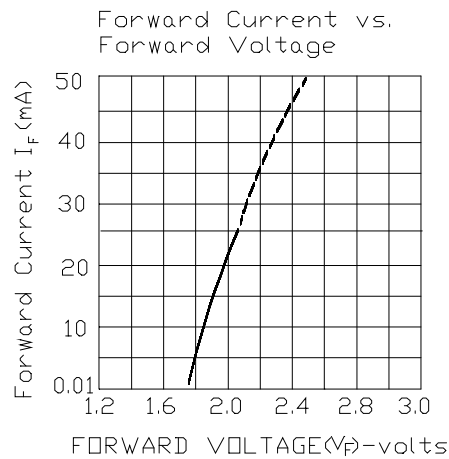
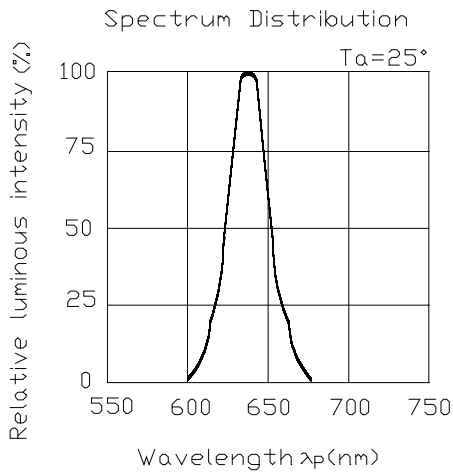



Technical Data Sheet

5.0mm 1pcs Circuit Board Indicator

**A1479-1B/SURSYGW/S530-A3**

■ Typical Electro-Optical Characteristic Curves:

(SYG)

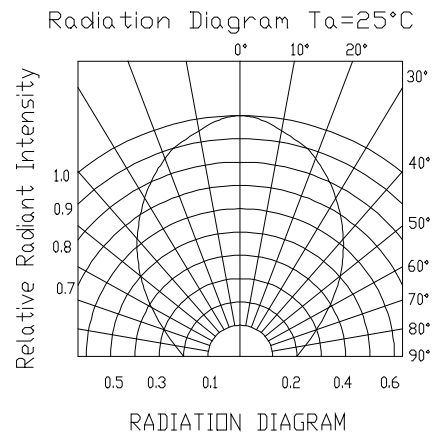
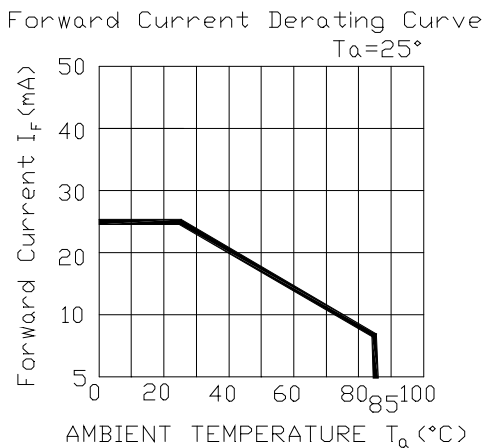
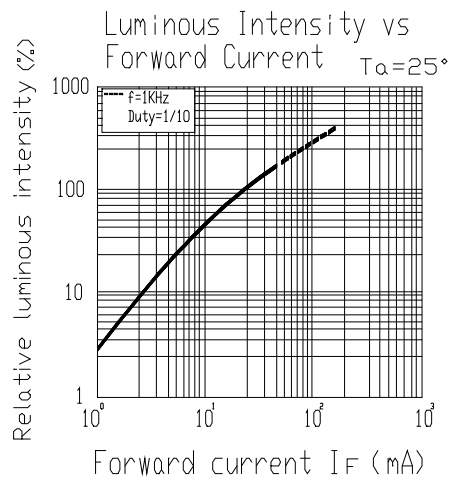
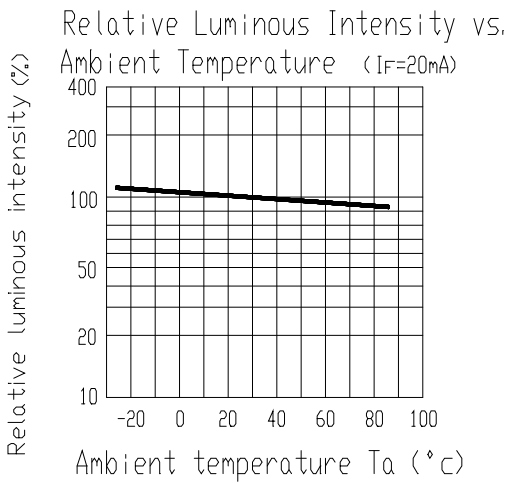
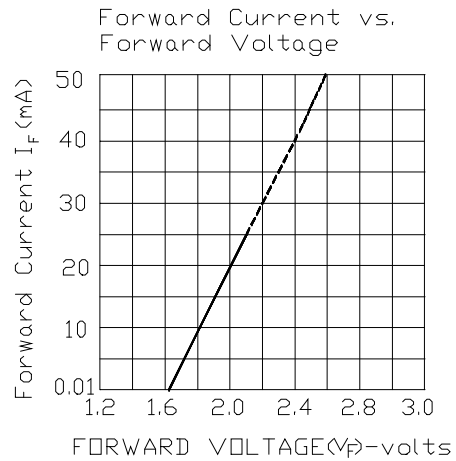
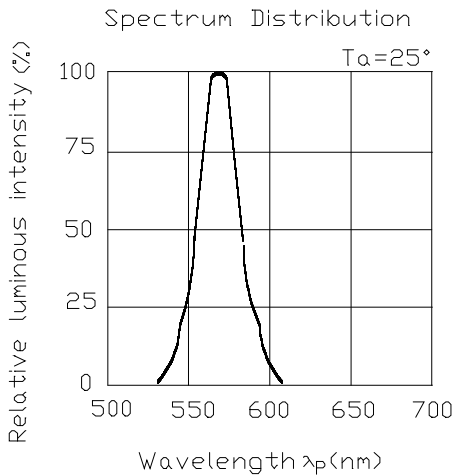



Technical Data Sheet

5.0mm 1pcs Circuit Board Indicator

A1479-1B/SURSYGW/S530-A3

■ Reliability test items and conditions:

The reliability of products shall be satisfied with items listed below.

Confidence level : 97%

LTPD : 3%

NO	Item	Test Conditions	Test Hours/Cycle	Sample Size	Failure Judgment Criteria	Ac/Re
1	Solder Heat	TEMP : 260°C ± 5 °C	10 SEC	76 PCS	$I_v \leq I_{vt} * 0.5$ or $V_f \geq U$ or $V_f \leq L$	0/1
2	Temperature Cycle	H : +100°C 15min ∩ 5 min L : -40°C 15min	300 CYCLES	76 PCS		0/1
3	Thermal Shock	H : +100°C 5min ∩ 10 sec L : -10°C 5min	300 CYCLES	76 PCS		0/1
4	High Temperature Storage	TEMP : 100°C	1000 HRS	76 PCS		0/1
5	Low Temperature Storage	TEMP : -40°C	1000 HRS	76 PCS		0/1
6	DC Operating Life	TEMP : 25°C I <sub>F</sub> = 20mA	1000 HRS	76 PCS		0/1
7	High Temperature / High Humidity	85°C / 85% RH	1000 HRS	76 PCS		0/1

Note : I<sub>vt</sub> : The test I<sub>v</sub> value of the chip before the reliability test

I<sub>v</sub> : The test value of the chip that has completed the reliability test

U : Upper Specification Limit

L : Lower Specification Limit



# EVERLIGHT ELECTRONICS CO.,LTD.

## Technical Data Sheet

### 5.0mm 1pcs Circuit Board Indicator

**A1479-1B/SURSYGW/S530-A3**

#### Packing Quantity Specification

1. 250pcs/1Bag , 4Bagss/1Box
2. 10Boxes/1Carton

#### Label Form Specification

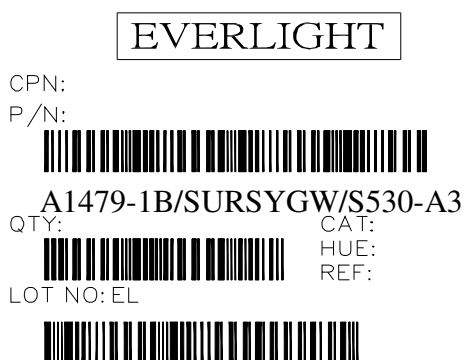

CPN: Customer' s Production Number  
P/N : Production Number  
QTY: Packing Quantity  
CAT: Ranks  
HUE: Peak Wavelength  
REF: Reference  
LOT No: Lot Number  
MADE IN TAIWAN: Production Place

MADE IN TAIWAN

#### Notes

1. Above specification may be changed without notice. EVERLIGHT will reserve authority on material change for above specification.
2. When using this product, please observe the absolute maximum ratings and the instructions for using outlined in these specification sheets. EVERLIGHT assumes no responsibility for any damage resulting from use of the product which does not comply with the absolute maximum ratings and the instructions included in these specification sheets.
3. These specification sheets include materials protected under copyright of EVERLIGHT corporation. Please don' t reproduce or cause anyone to reproduce them without EVERLIGHT' s consent.

<i>EVERLIGHT ELECTRONICS CO., LTD.</i>	<i>Tel: 886-2-2267-2000, 2267-9936</i>
<i>Office: No 25, Lane 76, Sec 3, Chung Yang Rd, Tucheng, Taipei 236, Taiwan, R.O.C</i>	<i>Fax: 886-2267-6244, 2267-6189, 2267-6306</i>
	<i>http://www.everlight.com</i>