



EVERLIGHT ELECTRONICS CO.,LTD.

DATA SHEET

PART NO. : 339-1SURSYGW/S530-A3/TR1®

DATE : 2002/8/29

DEPARTMENT : CHR&D1

REVISION : 1

RECEIVED			
<input checked="" type="checkbox"/> MASS PRODUCTION			
<input type="checkbox"/> PRELIMINARY			
<input type="checkbox"/> CUSTOMER DESIGN			
DEVICE NUMBER :		CDT1-033-055	
PAGE :		8	
CUSTOMER	DESIGNER	CHECKER	APPROVER

REV.	DESCRIPTION	RELEASE DATE

Office : 7C Building, Lian Hua Port Industrial District, Lian Hua Shan
 Bonded Processing Zone Pan Yu, Guang Zhou, China
 TEL. : (020)84860913,84860914
 FAX : (020)84860600
 http : //www.everlight.com



■ Package Dimensions:

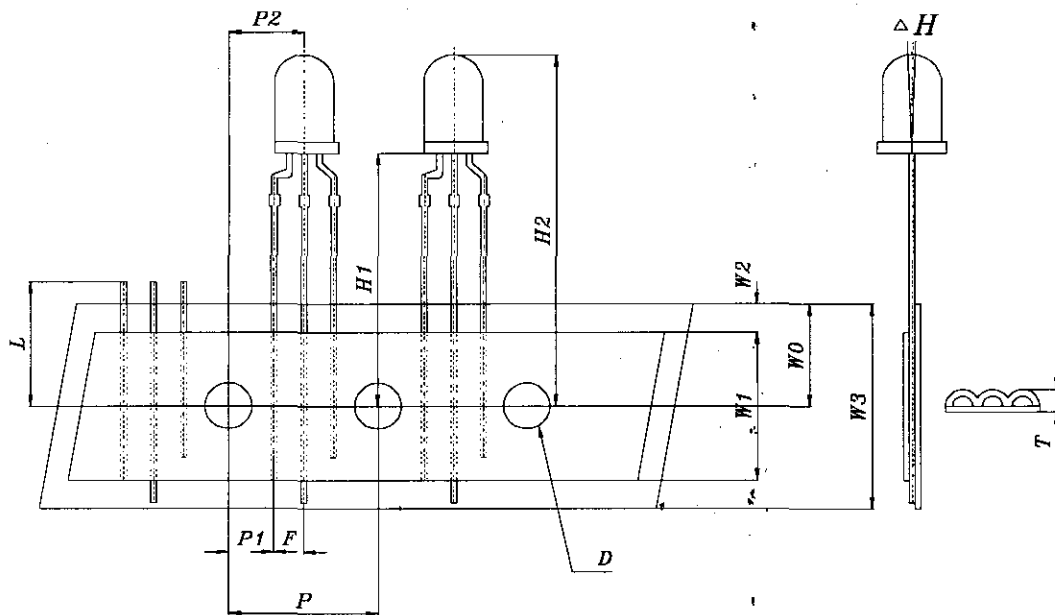

■ Notes:

- 1.All dimensions are in millimeters, tolerance is 0.25mm except being specified
- 2.Lead spacing is measured where the lead emerge from the package

OFFICE : NO. 25,Lane 76,Sec.3, Chung Yang Rd., Tucheng 236, Taipei, Taiwan, R.O.C.

TEL : 886-2-2267-2000,2267-9936

FAX : 886-2-2267-6244,22676189,22676306

<http://www.everlight.com>

T02632.R0208125



EVERLIGHT ELECTRONICS CO.,LTD.

Device Number : CDT1-033-055 REV.: 1

PART NO. : 339-1SURSYGW/S530-A3/TR1® ECN : _____ Page: 2/8

■ Package Dimensions:

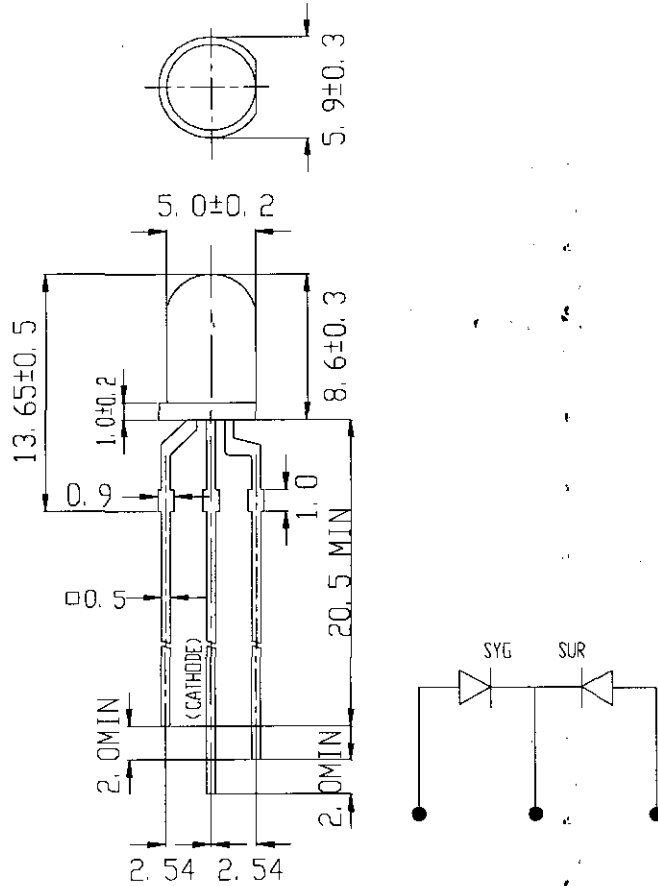

LED PART NO.	Chip		Lens Color
	Material	Emitted Color	
339-1SURSYGW/S530-A3	AlGaInP	Hyper Red	Water Clear
	AlGaInP	Super Yellow Green	

■ Notes:

1. All dimensions are in millimeters, tolerance is 0.25mm except being specified
2. Lead spacing is measured where the lead emerge from the package
3. Protuded resin under flange is 1.5 mm(0.059") Max LED.



EVERLIGHT ELECTRONICS CO.,LTD.

Device Number : CDT1-033-055 REV.: 1

PART NO. : 339-1SURSYGW/S530-A3/TR1® ECN : Page: 3/8

■ Descriptions:

- 1.The 339-1 lamp are made with AlGaN and AlGaN diodes, which emit Hyper Red and Super Yellow Geen light.
- 2.Automatically insertable with radial lead insertion equipmine.

■ Features:

- 1.Long life feature.
- 2.Low power consumption.
- 3.High emitting efficiency.
- 4.Most radial lead plastic LED lamp aailable packed in ape and reel.
- 5.Reel package simplifies handling and teating.

■ Applications:

- 1.Audio equipment
- 2.Monitor
- 3.Sign board
- 4.Computer peripheral
- 5.Air condition
- 6.Home appliance
- 7.Satellite receiver
- 8.Burglar alarm
- 9.Stop light

■ Preventing overcurrents:

- 1.Operating current can't be over DC forward current.
- 2.Circuit must be designed so that over voltage (overcurrent) is not applied the LED during ON/OFF switching. Transient or pulse current can damage the junction of the LED die.



EVERLIGHT ELECTRONICS CO.,LTD.

Device Number : CDT1-033-055 REV.: 1

PART NO. : 339-1SURSYGW/S530-A3/TR1® ECN : _____ Page: 4/8

Dimensions symbol informations (Ta=25°C)

Symbol Items	Sybmol	Specifications		
		Avg.		Tolerance
		mm	Inch	(mm)
Tape Feed Hole Diameter	D	4.0	0.157	±0.2
Component Lead Pitch	F	2.54	0.100	+0.8/-0.2
Front-to-Rear Deflection	ΔH	0°	0	±5°
Feed Hole to Button of Component	H1	18.50	0.728	±1.0
Feed Hole to Overall Component Height	H2	27.10	1.067	±1.0
Lead Length after Component Removal	L	11.00	0.433	MAX
Feed Hole Pitch	P	12.70	0.500	±0.3
Lead Location	P1	5.08	0.200	±0.7
Center of Component Location	P2	6.35	0.250	±1.2
Overall Taped Package Thickness	T	1.42	0.056	MAX
Feed Hole Location	W0	9.00	0.354	±0.5
Adhesive Tape Width	W1	13.00	0.512	±0.5
Adhesive Tape Position	W2	4.00	0.157	MAX
Tape Width	W3	18.00	0.709	±0.75

Package	Quantity/Reel	Order Increments
T-1	1000	1000

Package	Quantity/Ammo	Order Increments
T-1	2000	2000



EVERLIGHT ELECTRONICS CO.,LTD.

Device Number : CDT1-033-055 REV.: 1

PART NO. 339-1SURSYGW/S530-A3/TR1®

ECN : _____ Page: 5/8

Absolute Maximum Ratings at Ta = 25°C

Parameter	Symbol	Rating	Unit
Forward Current	IF	SUR 25	mA
		SYG 25	
Operating Temperature	Topr	-40 to +85	°C
Storage Temperature	Tstg	-40 to +100	°C
Soldering Temperature	Tsol	260 ± 5	°C
Electrostatic Discharge	ESD	2000	V
Power Dissipation	Pd	SUR 60	mW
		SYG 60	
Peak Forward Current (Duty 1/10 @ 1KHz)	IF(Peak)	SUR 160	mA
		SYG 160	
Reverse Voltage	VR	5	V

Electronic Optical Characteristics :

Parameter	Symbol	Min.	Typ.	Max.	Unit	Condition
Luminous Intensity	Iv	SUR 40.0	80.0	/	mcd	IF= 20 mA
		SYG 25.0				
Viewing Angle	2θ 1/2	/	70	/	deg	IF= 20 mA
Peak Wavelength	λ p	SUR /	632	/	nm	IF= 20 mA
		SYG /				
Dominant Wavelength	λ d	SUR /	624	/	nm	IF= 20 mA
		SUYG /				
Spectrum Radiation Bandwidth	Δ λ	SUR /	20	/	nm	IF= 20 mA
		SYG /				
Forward Voltage	VF	SUR /	2.0	2.4	V	IF= 20 mA
		SYG /				
Reverse Current	IR	/	/	10	μ A	VR= 5 V



EVERLIGHT ELECTRONICS CO.,LTD.

Device Number : CDT1-033-055 REV.: 1

PART NO. : 339-1SURSYGW/S530-A3/TR1® ECN : _____ Page: 6/8

■ Typical Electro-Optical Characteristic Curves:

(SUR)

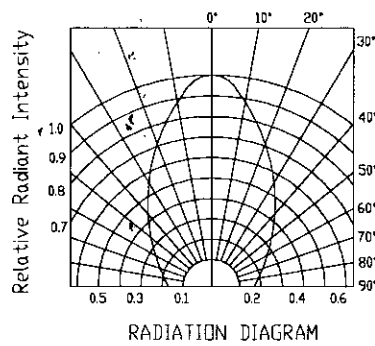
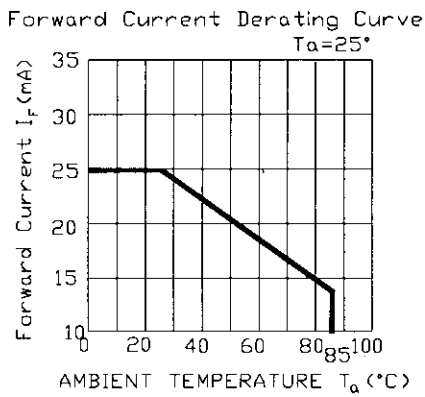
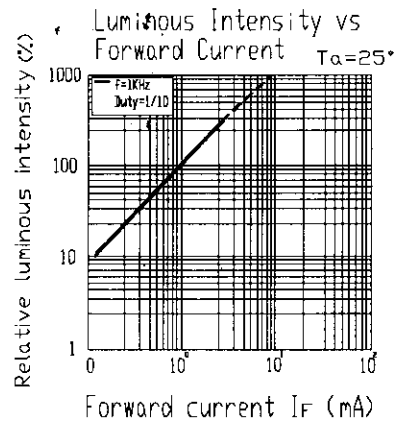
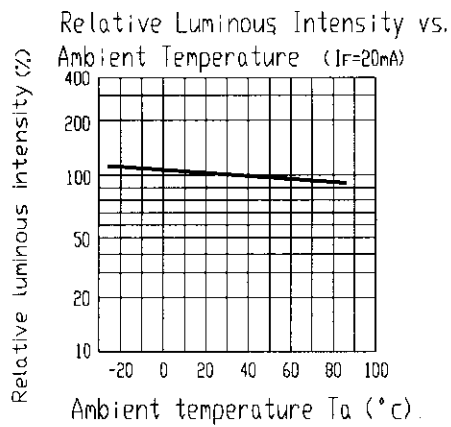
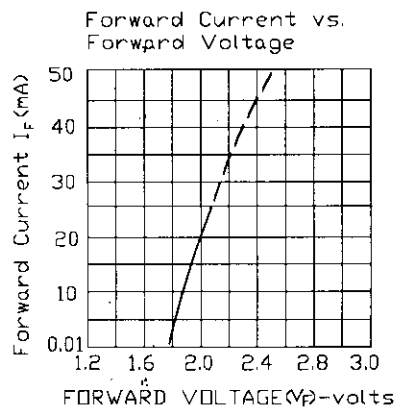
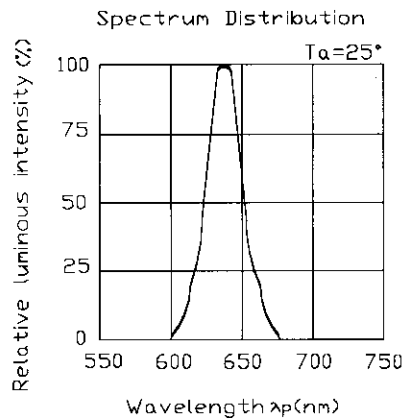



EVERLIGHT ELECTRONICS CO.,LTD.

Device Number : CDT1-033-055 REV.: 1

PART NO. : 339-1SURSYGW/S530-A3/TR1® ECN : _____ Page: 7/8

■ Typical Electro-Optical Characteristic Curves:

(SYG)

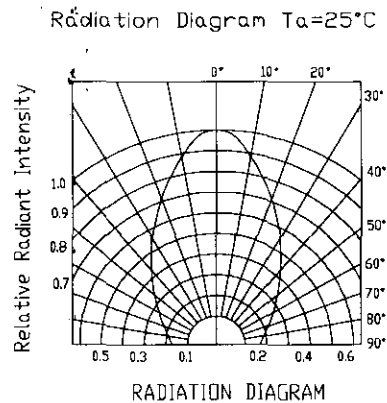
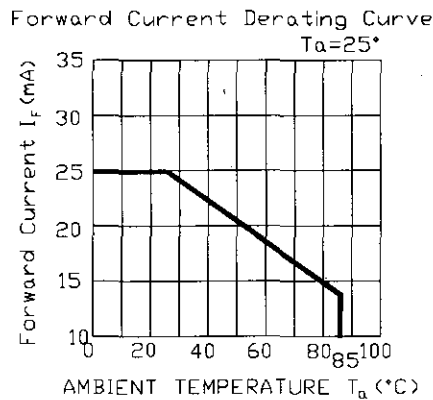
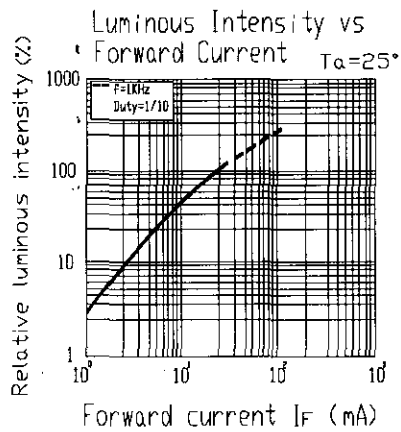
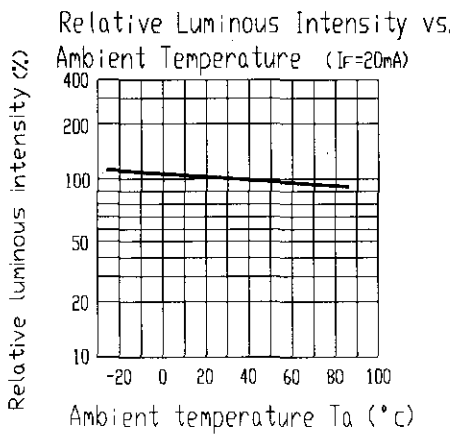
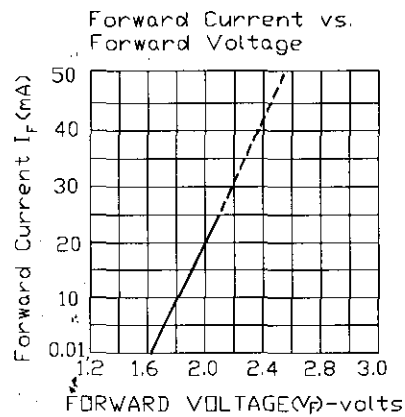
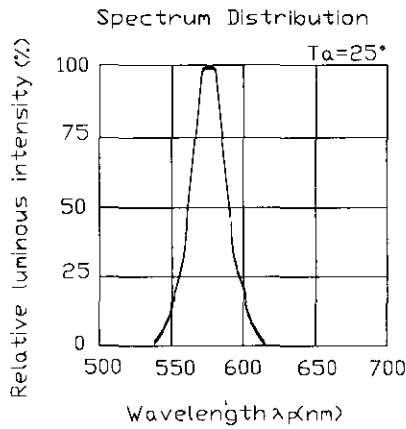



EVERLIGHT ELECTRONICS CO.,LTD.

Device Number : CDT1-033-055 REV.: 1

PART NO NO339-1SURSYGW/S530-A3/TR E CN : Page: 8/8

■ Reliability test items and conditions:

NO	Item	Test Conditions	Test Hours/Cycle	Sample Size	Ac/Re
1	Solder Heat	TEMP : 260°C ± 5 °C	5 SEC	76 PCS	0/1
2	Temperature Cycle	H : +85°C 30min ∫ 5 min L : -55°C 30min	50 CYCLES	76 PCS	0/1
3	Thermal Shock	H : +100°C 5min ∫ 10 sec L : -10°C 5min	50 CYCLES	76 PCS	0/1
4	High Temperature Storage	TEMP : 100°C	1000 HRS	100PCS	0/1
5	Low Temperature Storage	TEMP : -55°C	1000 HRS	76 PCS	0/1
6	DC Operating Life	TEMP : 25°C IF = 20 mA	1000 HRS	76 PCS	0/1
7	High Temperature / High Humidity	85°C/85% RH	1000 HRS	76 PCS	0/1