



Technical Data Sheet
3.0mm Multi-Color Round Type LED Lamps

209UYOSUGC/S530-A3

■ Features :

- Two chips are matched for uniform light output, wide viewing angle
- Long life-solid state reliability
- I.C. compatible/Low power consumption
- Pb free
- The product itself will remain within RoHS compliant version



■ Descriptions :

- The 209LED lamps contain two integral chips and is available as both bicolor and bipolar types.
- Super Yellow Orange and Super Green light is emitted by diodes of AlGaInP and InGaN/SiC
- Type of bicolor lamps are both white diffused and color diffused while the bicolor are water clear.

■ Applications :

- TV set
- Monitor
- Telephone
- Computer

PART NO.	Chip		Lens Color
	Material	Emitted Color	
209UYOSUGC/S530-A3	AlGaInP	Super Yellow Orange	Water Clear
	InGaN/SiC	Super Green	



Technical Data Sheet
3.0mm Multi-Color Round Type LED Lamps

209UYOSUGC/S530-A3

Package Dimensions

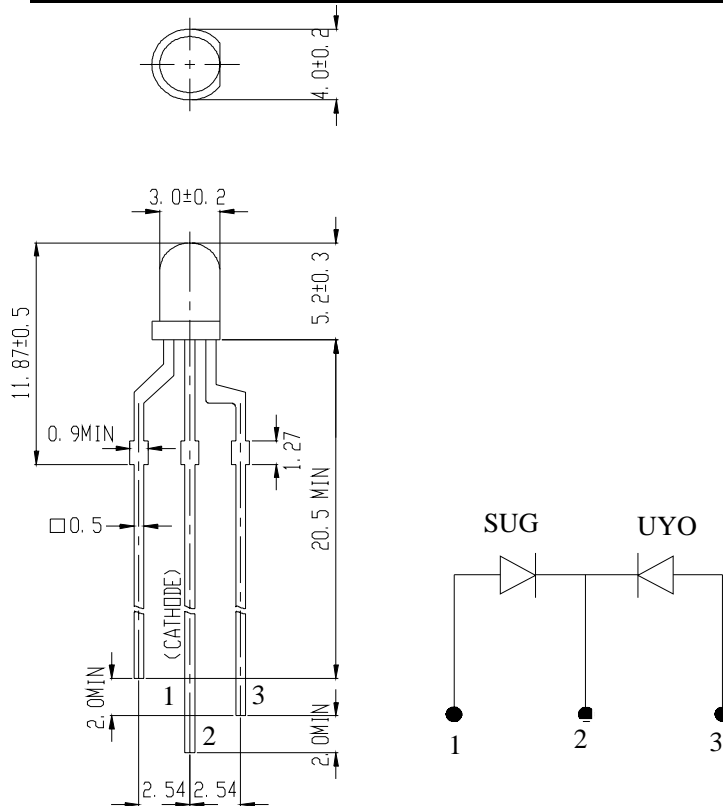

- Notes: 1. All dimensions are in millimetres
2. An epoxy meniscus may extend about 1.5mm(0.059") down to the lead.
3. Tolerances unless Dimension ± 0.25 mm.

■ Absolute Maximum Ratings at $T_a = 25^\circ\text{C}$

Parameter	Symbol	Rating		Unit
		UYO/S530	SUG/C525	
Forward Current	I_F	25	30	mA
Operating Temperature	T_{opr}	-40 to +85		$^\circ\text{C}$
Storage Temperature	T_{stg}	-40 to +100		$^\circ\text{C}$
Soldering Temperature	T_{sol}	260 ± 5		$^\circ\text{C}$
Electrostatic Discharge	ESD	UYO/S530	2000	V
		SUG/C525	1000	
Power Dissipation	P_d	UYO/S530	60	mW
		SUG/C525	130	
Reverse Voltage	V_R	5		V

Note: *1: Soldering time ≤ 5 seconds.



Technical Data Sheet
3.0mm Multi-Color Round Type LED Lamps

209UYOSUGC/S530-A3

Electro-Optical Characteristics (Ta=25°C)

Parameter	Symbol		Condition	Min.	Typ.	Max.	Unit
Forward Voltage	UYO/S530	V _F	I _F = 20 mA	/	2.0	2.4	V
	SUG/C525			/	3.5	4.3	
Reverse Current	UYO/S530	I _R	V _R = 5 V	/	/	10	μ A
	SUG/C525			/	/	50	
Luminous Intensity	UYO/S530	I _v	I _F = 20 mA	100	200	/	mcd
	SUG/C525			160	320	/	
Viewing Angle		2θ 1/2	I _F = 20 mA	/	50	/	deg
Peak Wavelength	UYO/S530	λ _p	I _F = 20 mA	/	611	/	nm
	SUG/C525			/	518	/	
Dominant Wavelength	UYO/S530	λ _d	I _F = 20 mA	/	605	/	nm
	SUG/C525			/	525	/	
Spectrum Radiation Bandwidth	UYO/S530	Δλ	I _F = 20 mA	/	17	/	nm
	SUG/C525			/	30	/	



Technical Data Sheet

3.0mm Multi-Color Round Type LED Lamps

209UYOSUGC/S530-A3

■ Typical Electro-Optical Characteristic Curves:

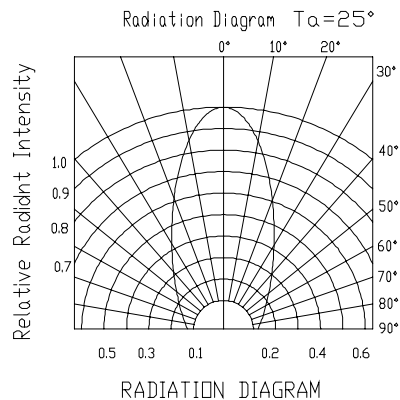
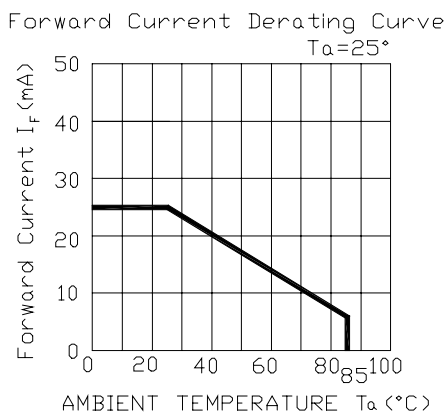
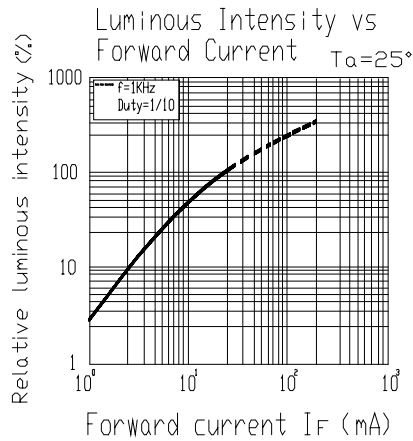
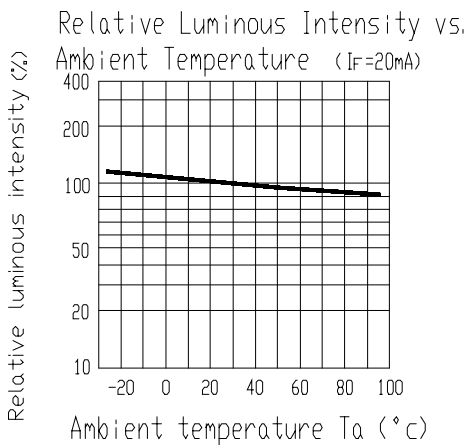
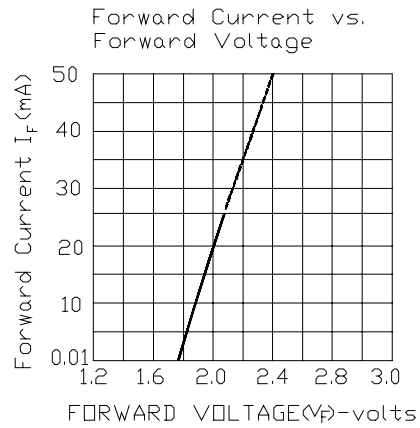
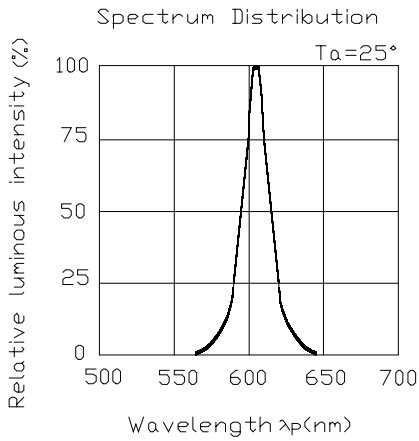



Technical Data Sheet

3.0mm Multi-Color Round Type LED Lamps

209UYOSUGC/S530-A3

Typical Electro-Optical Characteristic Curves:

SUG

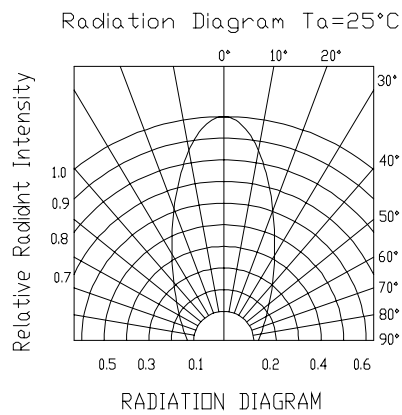
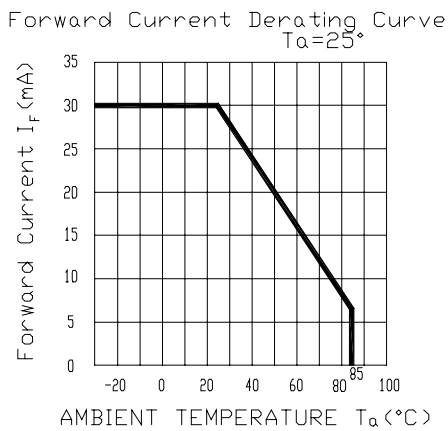
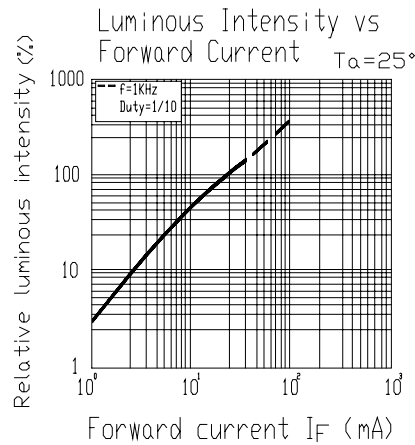
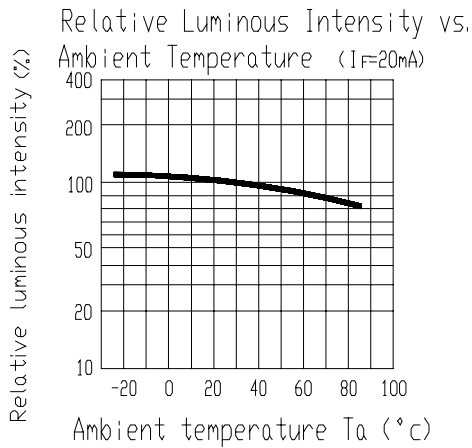
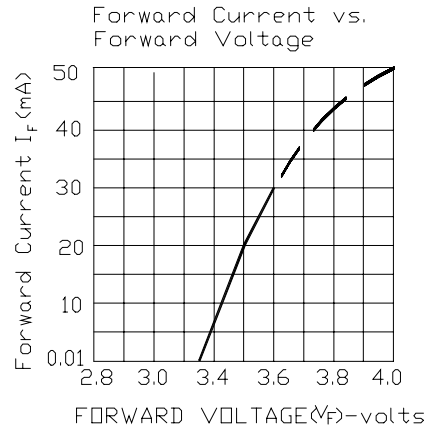
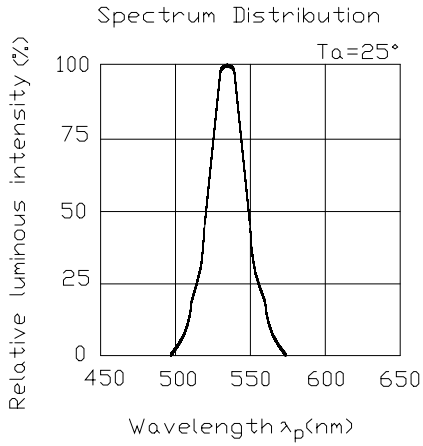



Technical Data Sheet

3.0mm Multi-Color Round Type LED Lamps

209UYOSUGC/S530-A3

■ Reliability test items and conditions:

The reliability of products shall be satisfied with items listed below.

Confidence level : 97%

LTPD : 3%

NO	Item	Test Conditions	Test Hours/Cycle	Sample Size	Failure Judgment Criteria	Ac/Re
1	Solder Heat	TEMP : 260°C ± 5 °C	10 SEC	76 PCS	Iv ≤ Ivt*0.5 or Vf ≥ U or Vf ≤ L	0/1
2	Temperature Cycle	H : +100°C 15min ∫ 5 min L : -40°C 15min	300 CYCLES	76 PCS		0/1
3	Thermal Shock	H : +100°C 5min ∫ 10 sec L : -10°C 5min	300 CYCLES	76 PCS		0/1
4	High Temperature Storage	TEMP : 100°C	1000 HRS	76 PCS		0/1
5	Low Temperature Storage	TEMP : -40°C	1000 HRS	76 PCS		0/1
6	DC Operating Life	TEMP : 25°C I _F = 20mA	1000 HRS	76 PCS		0/1
7	High Temperature / High Humidity	85°C / 85% RH	1000 HRS	76 PCS		0/1

Note : Ivt : To test Iv value of the chip before the reliability test
Iv : The test value of the chip that has completed the reliability test
U : Upper Specification Limit
L : Lower Specification Limit



Technical Data Sheet

3.0mm Multi-Color Round Type LED Lamps

209UYOSUGC/S530-A3

Packing Quantity Specification

1.1000PCS/1Bag , 4Bags/1Box

2.10Boxes/1Carton

Label Form Specification

EVERLIGHT

CPN:

P/N:



209UYOSUGC/S530-A3

QTY:



CAT:

HUE:

REF:

LOT NO: EL



CPN: Customer's Production Number

P/N : Production Number

QTY: Packing Quantity

CAT: Ranks

HUE: Dominant Wavelength

REF: Reference

LOT No: Lot Number

Notes

1. Above specification may be changed without notice. EVERLIGHT will reserve authority on material change for above specification.
2. When using this product, please observe the absolute maximum ratings and the instructions for using outlined in these specification sheets. EVERLIGHT assumes no responsibility for any damage resulting from use of the product which does not comply with the absolute maximum ratings and the instructions included in these specification sheets.
3. These specification sheets include materials protected under copyright of EVERLIGHT corporation. Please don't reproduce or cause anyone to reproduce them without EVERLIGHT's consent.

EVERLIGHT ELECTRONICS CO., LTD.

Office: No 25, Lane 76, Sec 3, Chung Yang Rd,

Tucheno Tainpei 236 Taiwan R O C

Tel: 886-2-2267-2000, 2267-9936

Fax: 886-2267-6244, 2267-6189, 2267-6306

http://www.everlight.com