



EVERLIGHT ELECTRONICS CO.,LTD.

# DATA SHEET

PART NO. : 209SURSYGC/S530-A3

DATE : 2003/7/2

DEPARTMENT : CHR&D1

REVISION : 2

<b>RECEIVED</b>			
<input checked="" type="checkbox"/> MASS PRODUCTION			
<input type="checkbox"/> PRELIMINARY			
<input type="checkbox"/> CUSTOMER DESIGN			
DEVICE NUMBER : CDLE-020-488			
PAGE : 7			
CUSTOMER	DESIGNER	CHECKER	APPROVER

2	Revision Update	2003/7/2
REV.	DESCRIPTION	RELEASE DATE

OFFICE: 7C BUILDING, LIAN HUA PORT INDUSTRIAL DISTRICT, LIAN HUA SHAN  
BONDED PRICESSING ZONE PAN YU, GUANG ZHU, CHINA

TEL. : (020)84860913,84860914

FAX : (020)84860600

[http : //www.everlight.com](http://www.everlight.com)



# Technical Data Sheet

## 3.0mm Multi-Color Round Type LED Lamps

**209SURSYGC/S530-A3**

### ■ Features :

- Two chips are matched for uniform light output, wide viewing angle
- Long life-solid state reliability
- I.C. compatible/Low power consumption

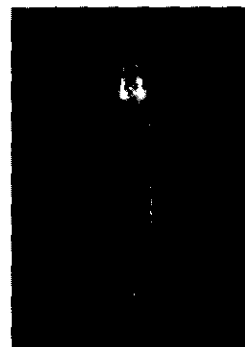

### ■ Descriptions :

- The 209 LED lamp contain two integral chips and is available as both bicolor and bipolar types.
- The Hyper Red and Super Yellow Green light is emitted by diodes of AlGaInP and AlGaInP respectively.
- Type of bipolar lamps are both White Diffused and Color Diffused while the bicolor are White Diffused

### ■ Applications :

- TV set
- Monitor
- Telephone
- Computer

PART NO.	Chip		Lens Color
	Material	Emitted Color	
209SURSYGC/S530-A3	AlGaInP	Hyper Red	Water Clear
	AlGaInP	Super Yellow Green	



# Technical Data Sheet

## 3.0mm Multi-Color Round Type LED Lamps

### 209SURSYGC/S530-A3

#### Package Dimensions

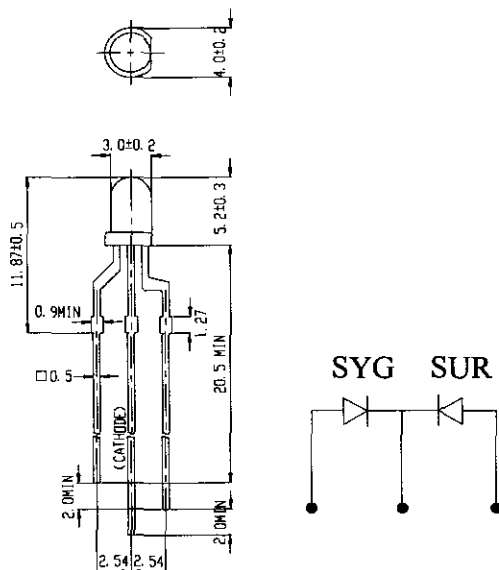

**Notes:** 1. All dimensions are in millimetres

2. An epoxy meniscus may extend about 1.5mm(0.059") down to the lead.
3. Tolerances unless Dimension  $\pm 0.25$ mm.

#### Absolute Maximum Ratings at $T_a = 25^\circ\text{C}$

Parameter	Symbol	Rating		Unit
Forward Current	I <sub>F</sub>	SUR/S530	25	mA
		SYG/S530	25	
Operating Temperature	T <sub>opr</sub>	-40 to +85		°C
Storage Temperature	T <sub>stg</sub>	-40 to +100		°C
Soldering Temperature	T <sub>sol</sub>	260 ± 5		°C
Electrostatic Discharge	ESD	2000		V
Power Dissipation	P <sub>d</sub>	SUR/S530	60	mW
		SYG/S530	60	
Peak Forward Current (Duty 1/10 @ 1KHz)	I <sub>F(Peak)</sub>	SUR/S530	160	mA
		SYG/S530	160	
Reverse Voltage	V <sub>R</sub>	5		V



## Technical Data Sheet

### 3.0mm Multi-Color Round Type LED Lamps

#### 209SURSYGC/S530-A3

#### Electro-Optical Characteristics (Ta=25°C)

Parameter	Symbol		Min.	Typ.	Max.	Unit	Condition
Luminous Intensity	I <sub>v</sub>	SUR/S530	63.0	125.0	/	mcd	I <sub>F</sub> = 20 mA
		SYG/S530	40.0	80.0	/		
Viewing Angle	2θ 1/2		/	60	/	deg	I <sub>F</sub> = 20 mA
Peak Wavelength	λ <sub>p</sub>	SUR/S530	/	632	/	nm	I <sub>F</sub> = 20 mA
		SYG/S530	/	575	/		
Dominant Wavelength	λ <sub>d</sub>	SUR/S530	/	624	/	nm	I <sub>F</sub> = 20 mA
		SYG/S530	/	573	/		
Spectrum Radiation Bandwidth	Δλ	SUR/S530	/	20	/	nm	I <sub>F</sub> = 20 mA
		SYG/S530	/	20	/		
Forward Voltage	V <sub>F</sub>	SUR/S530	/	2.0	2.4	V	I <sub>F</sub> = 20 mA
		SYG/S530	/	2.0	2.4		
Reverse Current	I <sub>R</sub>		/	/	10	μA	V <sub>R</sub> = 5 V



# Technical Data Sheet

## 3.0mm Multi-Color Round Type LED Lamps

### 209SURSYGC/S530-A3

#### Typical Electro-Optical Characteristic Curves:

(SUR)

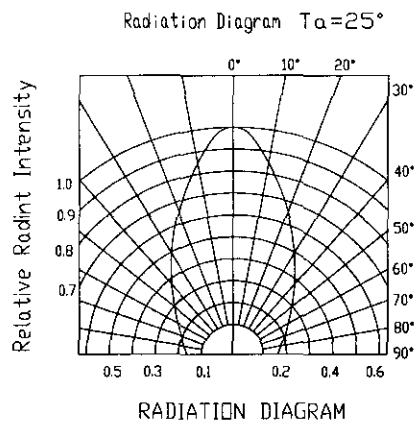
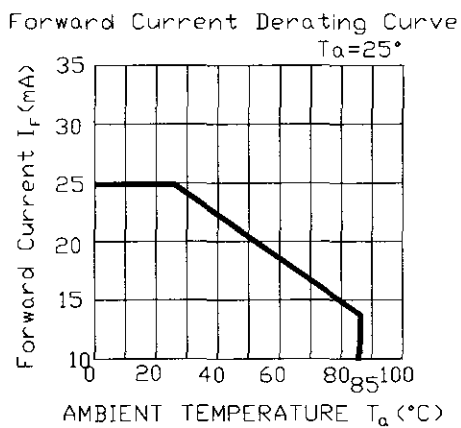
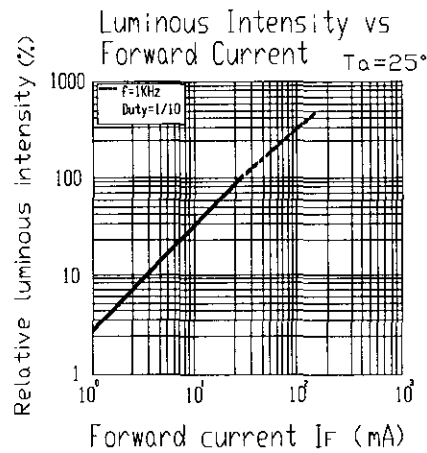
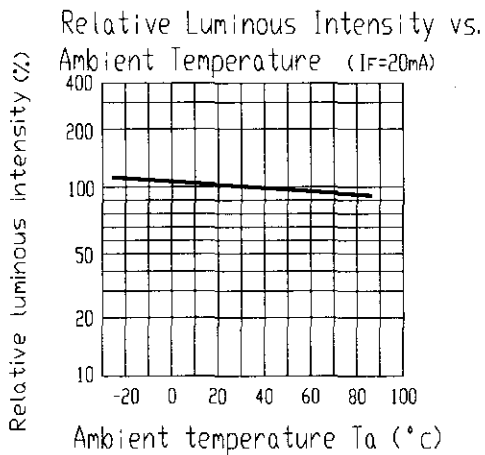
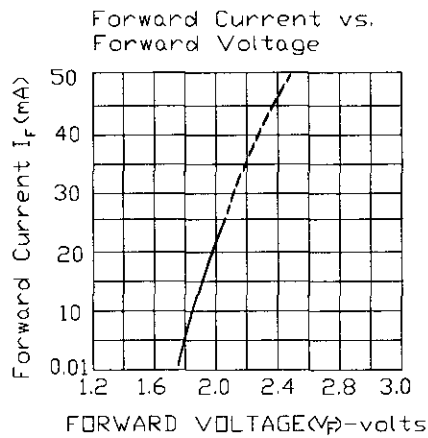
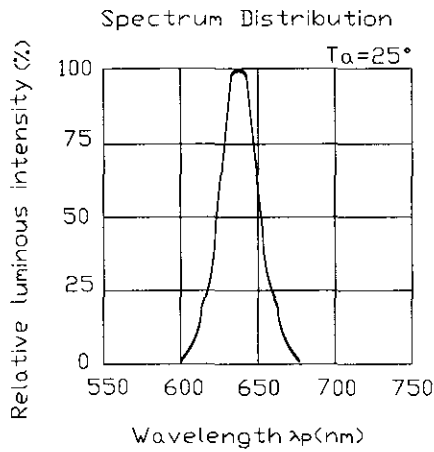



# Technical Data Sheet

## 3.0mm Multi-Color Round Type LED Lamps

### 209SURSYGC/S530-A3

#### Typical Electro-Optical Characteristic Curves:

(SYG)

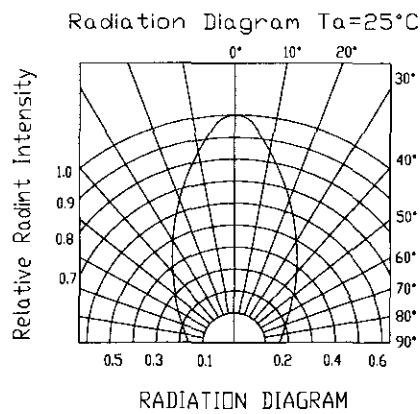
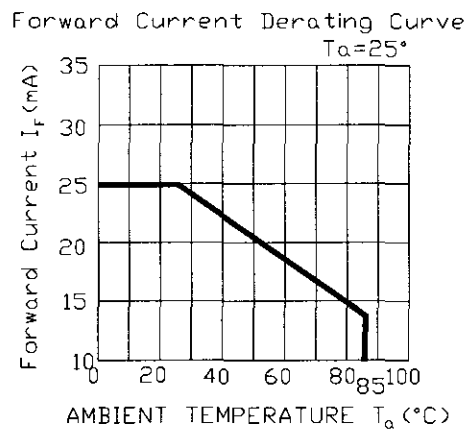
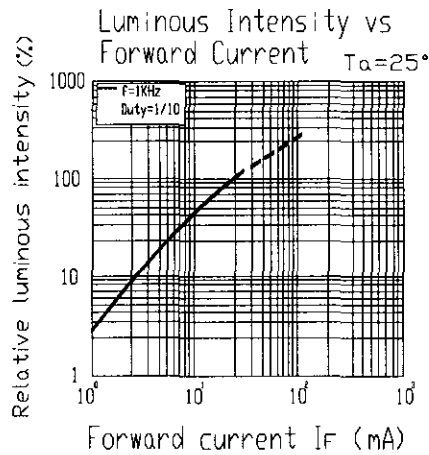
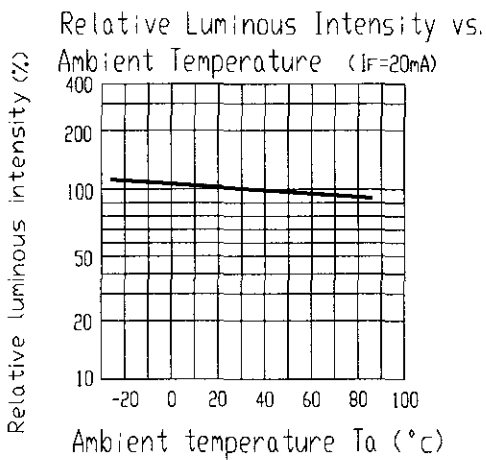
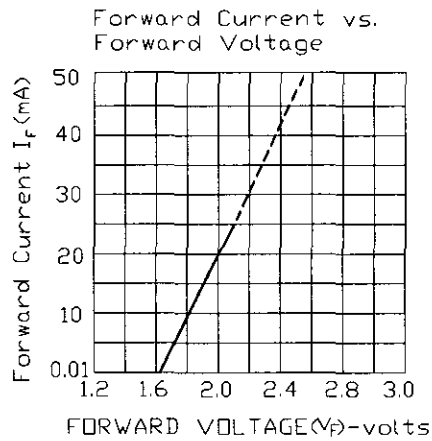
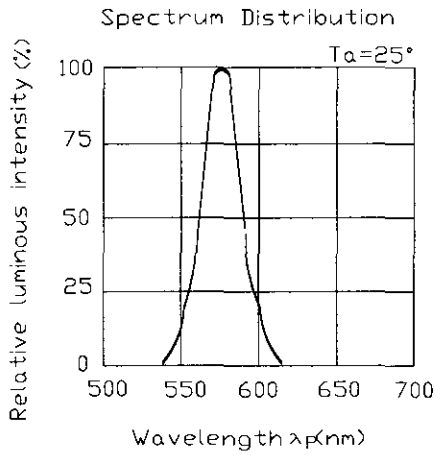

Technical Data Sheet  
3.0mm Multi-Color Round Type LED Lamps

**209SURSYGC/S530-A3**

## ■ Reliability test items and conditions:

NO	Item	Test Conditions	Test Hours/Cycle	Sample Size	Ac/Re
1	Solder Heat	TEMP : 260°C ± 5 °C	10 SEC	76 PCS	0/1
2	Temperature Cycle	H : +100°C 15min § 5 min L : -40°C 15min	300 CYCLES	76 PCS	0/1
3	Thermal Shock	H : +100°C 5min § 10 sec L : -10°C 5min	300 CYCLES	76 PCS	0/1
4	High Temperature Storage	TEMP : 100°C	1000 HRS	76 PCS	0/1
5	Low Temperature Storage	TEMP : -40°C	1000 HRS	76 PCS	0/1
6	DC Operating Life	TEMP : 25°C IF = 20mA	1000 HRS	76 PCS	0/1
7	High Temperature / High Humidity	85°C / 85% RH	1000 HRS	76 PCS	0/1



# Technical Data Sheet

## 3.0mm Multi-Color Round Type LED Lamps

**209SURSYGC/S530-A3**

### Packing Quantity Specification

1.500PCS/1Bag , 6Bags/1Box

2.10Boxes/1Carton

### Label Form Specification



CPN:

P/N:



209SURSYGC/S530-A3

QTY:



CAT:

HUE:

REF:

LOT NO: EL

MADE IN TAIWAN

CPN: Customer's Production Number

P/N : Production Number

QTY: Packing Quantity

CAT: Ranks

HUE: Peak Wavelength

REF: Reference

LOT No: Lot Number

MADE IN TAIWAN: Production Place

### Notes

1. Above specification may be changed without notice. EVERLIGHT will reserve authority on material change for above specification.
2. When using this product, please observe the absolute maximum ratings and the instructions for using outlined in these specification sheets. EVERLIGHT assumes no responsibility for any damage resulting from use of the product which does not comply with the absolute maximum ratings and the instructions included in these specification sheets.
3. These specification sheets include materials protected under copyright of EVERLIGHT corporation. Please don't reproduce or cause anyone to reproduce them without EVERLIGHT's consent.

EVERLIGHT ELECTRONICS CO., LTD.

Tel: 886-2-2267-2000, 2267-9936

Office: No 25, Lane 76, Sec 3, Chung Yang Rd,

Fax: 886-2267-6244, 2267-6189, 2267-6306

Tucheng, Taipei 236, Taiwan, R.O.C.

<http://www.everlight.com>