



Technical Data Sheet

3.0mm Multi-Color Round Type LED Lamps

1259-7SDRSYGW/S530-A3

■ Features :

- Two chips are matched for uniform light output, wide viewing angle
- Long life-solid state reliability
- I.C. compatible/Low power consumption
- Pb free
- The product itself will remain within RoHS compliant version

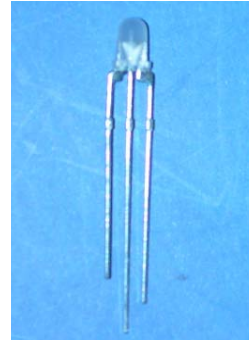

■ Descriptions :

- The 1259-7LED lamps contain two integral chips and is available as both bicolor and bipolar types.
- Super Deep-Red and Super Yellow Green light is emitted by diodes of AlGaInP and AlGaInP
- Type of bicolor lamps are both white diffused and color diffused while the bicolor are water clear.

■ Applications :

- TV set
- Monitor
- Telephone
- Computer

| PART NO. | Chip | | Lens Color |
|-----------------------|----------|--------------------|----------------|
| | Material | Emitted Color | |
| 1259-7SDRSYGW/S530-A3 | AlGaInP | Super Deep-Red | White Diffused |
| | AlGaInP | Super Yellow Green | |



Technical Data Sheet
3.0mm Multi-Color Round Type LED Lamps

1259-7SDRSYGW/S530-A3

Package Dimensions

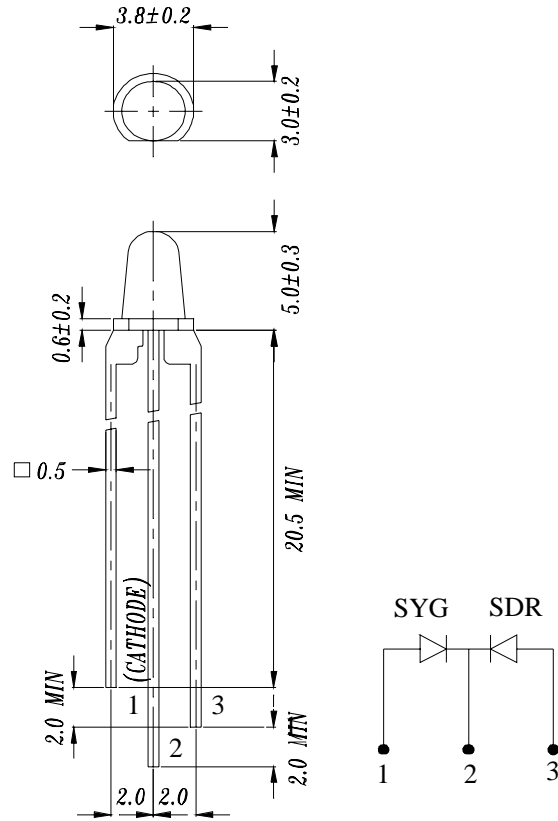

- Notes: 1. All dimensions are in millimetres
2. An epoxy meniscus may extend about 1.5mm(0.059") down to the lead.
3. Tolerances unless Dimension ± 0.25 mm.

■ Absolute Maximum Ratings at $T_a = 25^\circ\text{C}$

| Parameter | Symbol | Rating | | Unit |
|-------------------------|------------------|-------------|----------|------|
| | | SDR/S530 | SYG/S530 | |
| Forward Current | I _F | 25 | 25 | mA |
| | | | | |
| Operating Temperature | T _{opr} | -40 to +85 | | °C |
| Storage Temperature | T _{stg} | -40 to +100 | | °C |
| Soldering Temperature | T _{sol} | 260 ± 5 | | °C |
| Electrostatic Discharge | ESD | 2000 | 2000 | V |
| | | | | |
| Power Dissipation | P _d | 60 | 60 | mW |
| | | | | |
| Reverse Voltage | V _R | 5 | | V |

Note: *1: Soldering time ≤ 5 seconds.



Technical Data Sheet
3.0mm Multi-Color Round Type LED Lamps

1259-7SDRSYGW/S530-A3

Electro-Optical Characteristics (Ta=25°C)

| Parameter | Symbol | | Condition | Min. | Typ. | Max. | Unit |
|------------------------------|----------|----------------|------------------------|------|------|------|------|
| Forward Voltage | SDR/S530 | V _F | I _F = 20 mA | / | 2.0 | 2.4 | V |
| | SYG/S530 | | | / | 2.0 | 2.4 | |
| Reverse Current | SDR/S530 | I _R | V _R = 5 V | / | / | 10 | μ A |
| | SYG/S530 | | | / | / | 10 | |
| Luminous Intensity | SDR/S530 | I _v | I _F = 20 mA | 16 | 32 | / | mcd |
| | SYG/S530 | | | 25 | 50 | / | |
| Viewing Angle | | 2θ 1/2 | I _F = 20 mA | / | 50 | / | deg |
| Peak Wavelength | SDR/S530 | λ _p | I _F = 20 mA | / | 650 | / | nm |
| | SYG/S530 | | | / | 575 | / | |
| Dominant Wavelength | SDR/S530 | λ _d | I _F = 20 mA | / | 639 | / | nm |
| | SYG/S530 | | | / | 573 | / | |
| Spectrum Radiation Bandwidth | SDR/S530 | Δλ | I _F = 20 mA | / | 20 | / | nm |
| | SYG/S530 | | | / | 20 | / | |



Technical Data Sheet

3.0mm Multi-Color Round Type LED Lamps

1259-7SDRSYGW/S530-A3

Typical Electro-Optical Characteristic Curves:

(SDR)

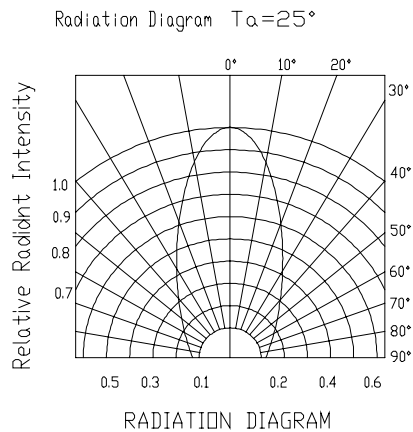
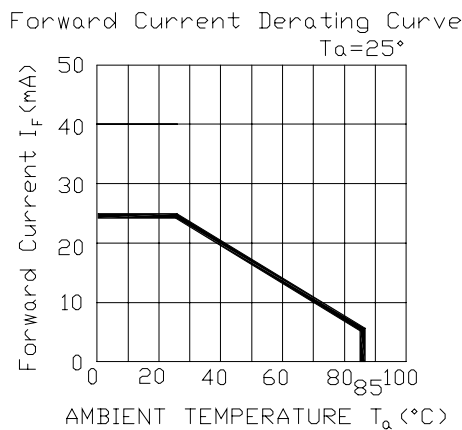
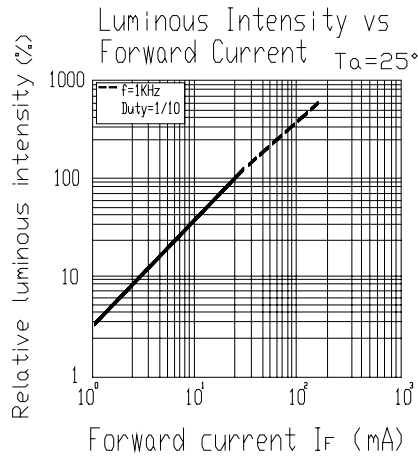
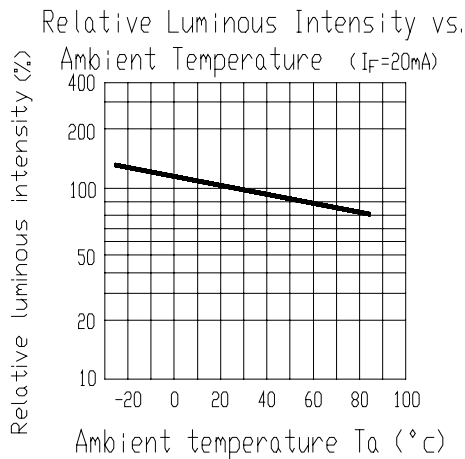
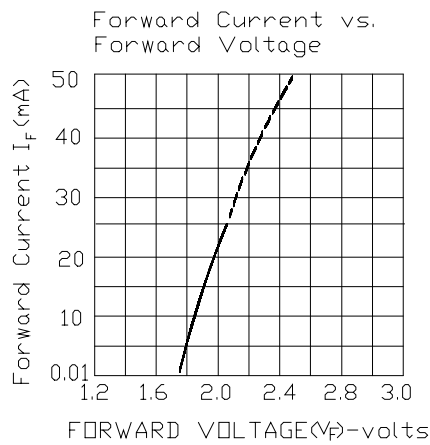
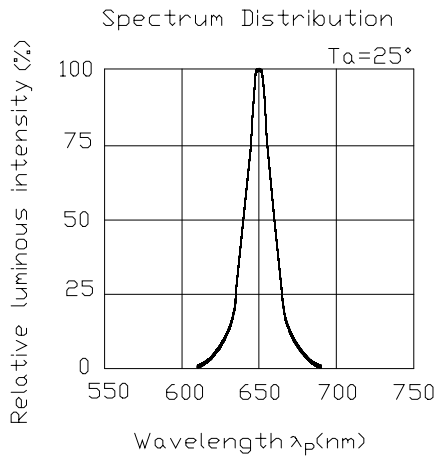



Technical Data Sheet

3.0mm Multi-Color Round Type LED Lamps

1259-7SDRSYGW/S530-A3

Typical Electro-Optical Characteristic Curves:

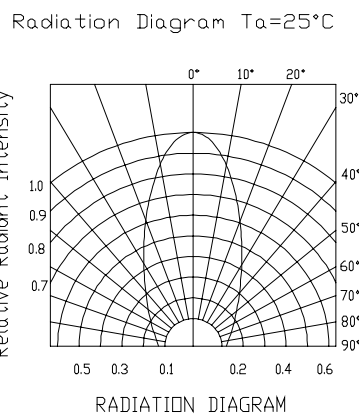
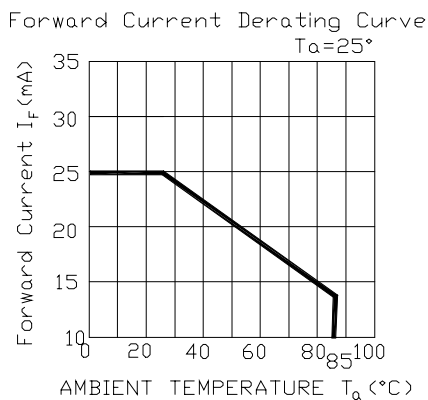
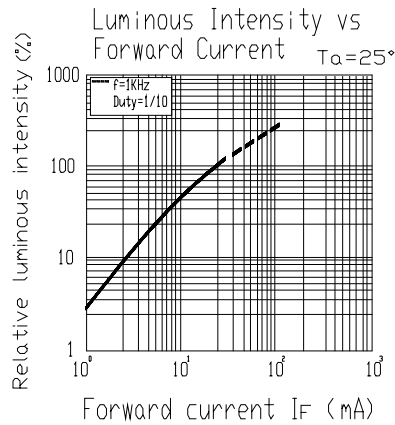
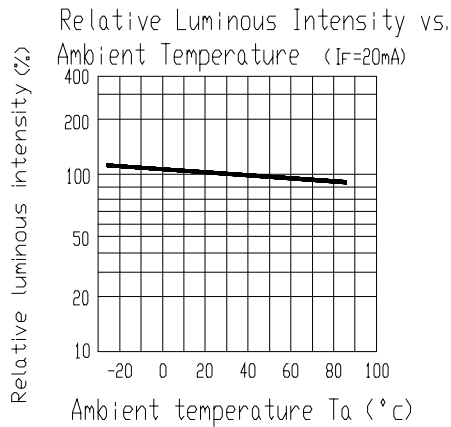
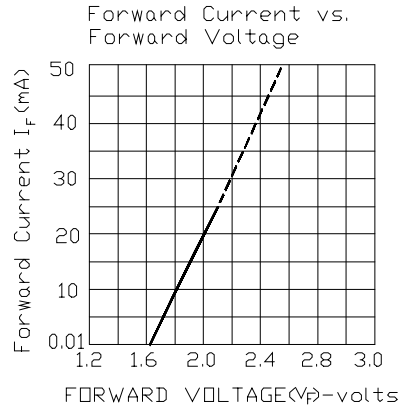
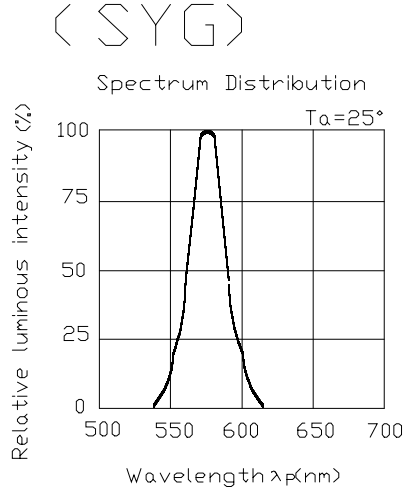



Technical Data Sheet

3.0mm Multi-Color Round Type LED Lamps

1259-7SDRSYGW/S530-A3

■ Reliability test items and conditions:

The reliability of products shall be satisfied with items listed below.

Confidence level : 97%

LTPD : 3%

| NO | Item | Test Conditions | Test Hours/Cycle | Sample Size | Failure Judgment Criteria | Ac/Re |
|----|----------------------------------|--|------------------|-------------|----------------------------------|-------|
| 1 | Solder Heat | TEMP : 260°C ± 5 °C | 10 SEC | 76 PCS | Iv ≤ Ivt*0.5 or Vf ≥ U or Vf ≤ L | 0/1 |
| 2 | Temperature Cycle | H : +100°C 15min ∫ 5 min L : -40°C 15min | 300 CYCLES | 76 PCS | | 0/1 |
| 3 | Thermal Shock | H : +100°C 5min ∫ 10 sec L : -10°C 5min | 300 CYCLES | 76 PCS | | 0/1 |
| 4 | High Temperature Storage | TEMP : 100°C | 1000 HRS | 76 PCS | | 0/1 |
| 5 | Low Temperature Storage | TEMP : -40°C | 1000 HRS | 76 PCS | | 0/1 |
| 6 | DC Operating Life | TEMP : 25°C I _F = 20mA | 1000 HRS | 76 PCS | | 0/1 |
| 7 | High Temperature / High Humidity | 85°C / 85% RH | 1000 HRS | 76 PCS | | 0/1 |

Note : Ivt : To test Iv value of the chip before the reliability test
Iv : The test value of the chip that has completed the reliability test
U : Upper Specification Limit
L : Lower Specification Limit



Technical Data Sheet

3.0mm Multi-Color Round Type LED Lamps

1259-7SDRSYGW/S530-A3

Packing Quantity Specification

1.1000PCS/1Bag , 4Bags/1Box

2.10Boxes/1Carton

Label Form Specification

EVERLIGHT

CPN:

P/N:



1259-7SDRSYGW/S530-A3

QTY:



CAT:

HUE:

REF:

LOT NO: EL



CPN: Customer's Production Number

P/N : Production Number

QTY: Packing Quantity

CAT: Ranks

HUE: Dominant Wavelength

REF: Reference

LOT No: Lot Number

Notes

1. Above specification may be changed without notice. EVERLIGHT will reserve authority on material change for above specification.
2. When using this product, please observe the absolute maximum ratings and the instructions for using outlined in these specification sheets. EVERLIGHT assumes no responsibility for any damage resulting from use of the product which does not comply with the absolute maximum ratings and the instructions included in these specification sheets.
3. These specification sheets include materials protected under copyright of EVERLIGHT corporation. Please don't reproduce or cause anyone to reproduce them without EVERLIGHT's consent.

EVERLIGHT ELECTRONICS CO., LTD.

Office: No 25, Lane 76, Sec 3, Chung Yang Rd,

Tucheno Tainpei 236 Taiwan R O C

Tel: 886-2-2267-2000, 2267-9936

Fax: 886-2267-6244, 2267-6189, 2267-6306

<http://www.everlight.com>