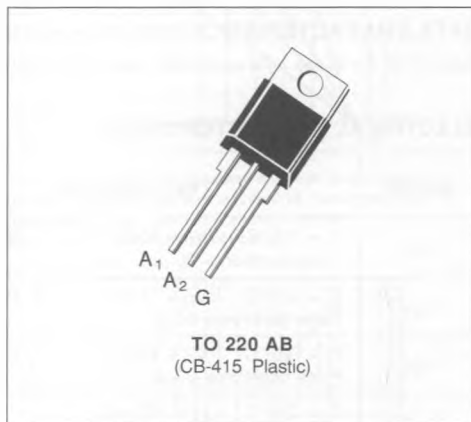

SNUBBERLESS TRIACS

- $I_{TRMS} = 6 \text{ A}$ at $T_c = 95 \text{ }^\circ\text{C}$.
- $V_{DRM} : 200 \text{ V}$ to 800 V .
- $I_{GT} = 50 \text{ mA}$ (QI-II-III).
- GLASS PASSIVATED CHIP.
- HIGH SURGE CURRENT : $I_{TSM} = 60 \text{ A}$.
- HIGH COMMUTATION CAPABILITY :
 $(di/dt)_c > 5 \text{ A / ms}$ without snubber.
- INSULATING VOLTAGE : $2500 V_{RMS}$.

DESCRIPTION
ABSOLUTE RATINGS (limiting values)

Symbol	Parameter		Value	Unit
I_{TRMS}	RMS on-state current (360 ° conduction angle)	$T_c = 95 \text{ }^\circ\text{C}$	6	A
I_{TSM}	Non repetitive surge peak on-state current (T_j initial = $25 \text{ }^\circ\text{C}$)	$t = 8.3 \text{ ms}$	63	A
		$t = 10 \text{ ms}$	60	
$I^2 t$	$I^2 t$ value	$t = 10 \text{ ms}$	18	$\text{A}^2 \text{ s}$
di/dt	Critical rate of rise of on-state current (1)	Repetitive $F = 50 \text{ Hz}$	20	A / μs
		Non Repetitive	100	
T_{stg} T_j	Storage and operating junction temperature range		- 40, + 150 - 40, + 125	$^\circ\text{C}$ $^\circ\text{C}$

Symbol	Parameter	BTA 06-					Unit
		200 BW	400 BW	600 BW	700 BW	800 BW	
V_{DRM}	Repetitive peak off-state voltage (2)	± 200	± 400	± 600	± 700	± 800	V

 (1) Gate supply : $I_G = 500 \text{ mA} - di_G / dt = 1 \text{ A / } \mu\text{s}$.

 (2) $T_j = 125 \text{ }^\circ\text{C}$.

THERMAL RESISTANCES

Symbol	Parameter	Value	Unit
$R_{th(j-a)}$	Junction to ambient	60	°C/W
$R_{th(j-c)}$ DC	Junction to case for DC	4.3	°C/W
$R_{th(j-c)}$ AC	Junction to case for 360° conduction angle (F = 50 Hz)	3.2	°C/W

GATE CHARACTERISTICS (maximum values)

$P_{GM} = 40\text{ W}$ ($t = 10\ \mu\text{s}$) $P_{G(AV)} = 1\text{ W}$ $I_{GM} = 4\text{ A}$ ($t = 10\ \mu\text{s}$) $V_{GM} = 16\text{ V}$ ($t = 10\ \mu\text{s}$).

ELECTRICAL CHARACTERISTICS

Symbol	Test Conditions			Quadrants	Min.	Typ.	Max.	Unit
I_{GT}	$T_j = 25\text{ °C}$ Pulse duration > 20 μs	$V_D = 12\text{ V}$ $R_L = 33\ \Omega$		I-II-III	2		50	mA
V_{GT}	$T_j = 25\text{ °C}$ Pulse duration > 20 μs	$V_D = 12\text{ V}$ $R_L = 33\ \Omega$		I-II-III			1.5	V
V_{GD}	$T_j = 125\text{ °C}$ Pulse duration > 20 μs	$V_D = V_{DRM}$ $R_L = 3.3\text{ k}\Omega$		I-II-III	0.2			V
I_H^*	$T_j = 25\text{ °C}$ Gate open	$I_T = 100\text{ mA}$ $R_L = 140\ \Omega$					50	mA
I_G	$T_j = 25\text{ °C}$ Pulse duration > 20 μs	$V_D = 12\text{ V}$ $I_G = 500\text{ mA}$		I-III		50		mA
				II		100		
V_{TM}^*	$T_j = 25\text{ °C}$	$I_{TM} = 8.5\text{ A}$	$t_p = 10\text{ ms}$				1.75	V
I_{DRM}^*	$T_j = 25\text{ °C}$	V_{DRM} rated	Gate open				0.01	mA
	$T_j = 125\text{ °C}$						2	
dv/dt^*	$T_j = 125\text{ °C}$ Linear slope up to 0.67 V_{DRM}	Gate open			500	750		V/ μs
$(di/dt)_c^*$	$T_j = 125\text{ °C}$ Without snubber	V_{DRM} rated			5	10		A/ms
t_{gt}	$T_j = 25\text{ °C}$ $I_T = 8.5\text{ A}$	$di_G/dt = 3.5\text{ A}/\mu\text{s}$ $V_D = V_{DRM}$	$I_G = 500\text{ mA}$	I-II-III		2		μs

* For either polarity of electrode A₂ voltage with reference to electrode A₁.

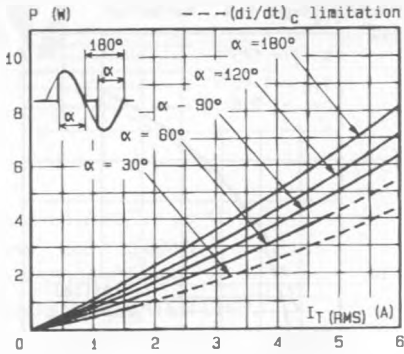

Fig. 1 - Maximum mean power dissipation versus RMS on-state current ($F = 60$ Hz).

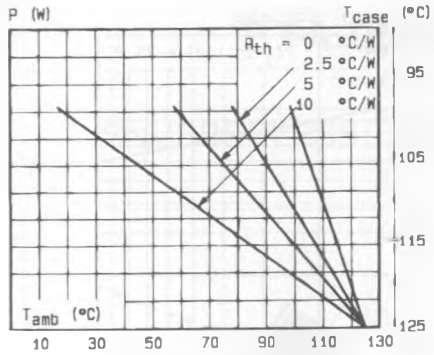

Fig. 2 - Correlation between maximum mean power dissipation and maximum allowable temperatures (T_{amb} and T_{case}) for different thermal resistances heatsink + contact.

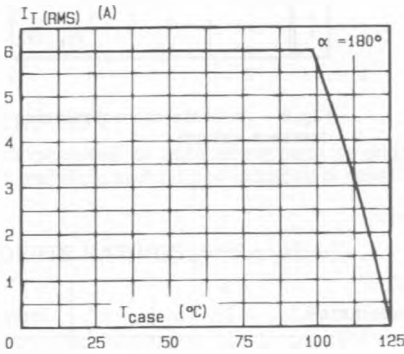

Fig. 3 - RMS on-state current versus case temperature.

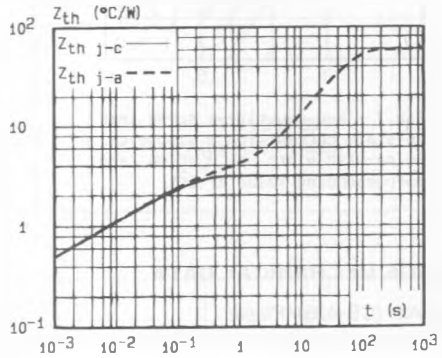

Fig. 4 - Thermal transient impedance junction to case and junction to ambient versus pulse duration.

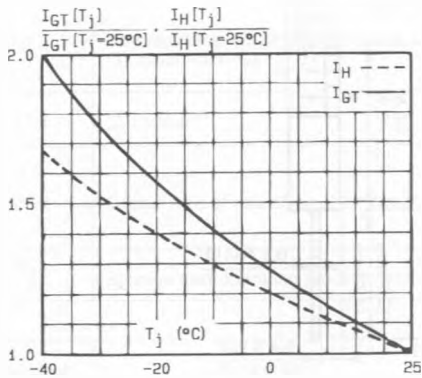

Fig. 5 - Relative variation of gate trigger current and holding current versus junction temperature.

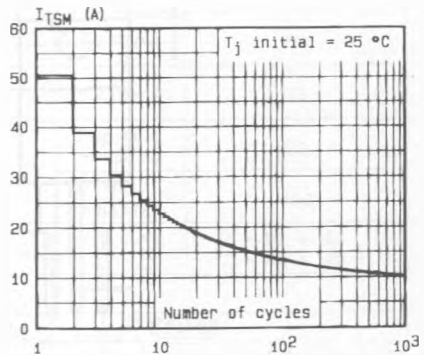

Fig. 6 - Non repetitive surge peak on-state current versus number of cycles.

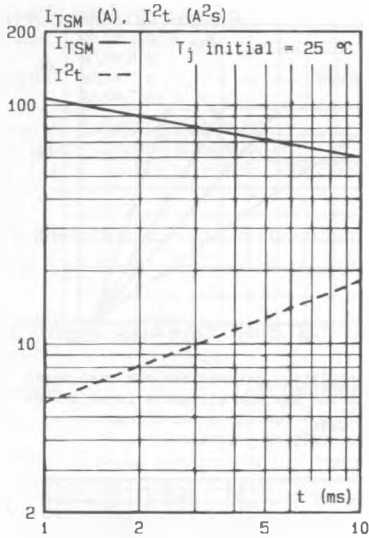

Fig.7 - Non repetitive surge peak on-state current for a sinusoidal pulse with width: $t \leq 10$ ms, and corresponding value of I^2t .

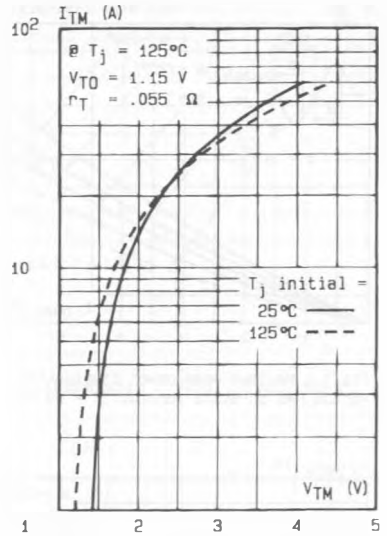
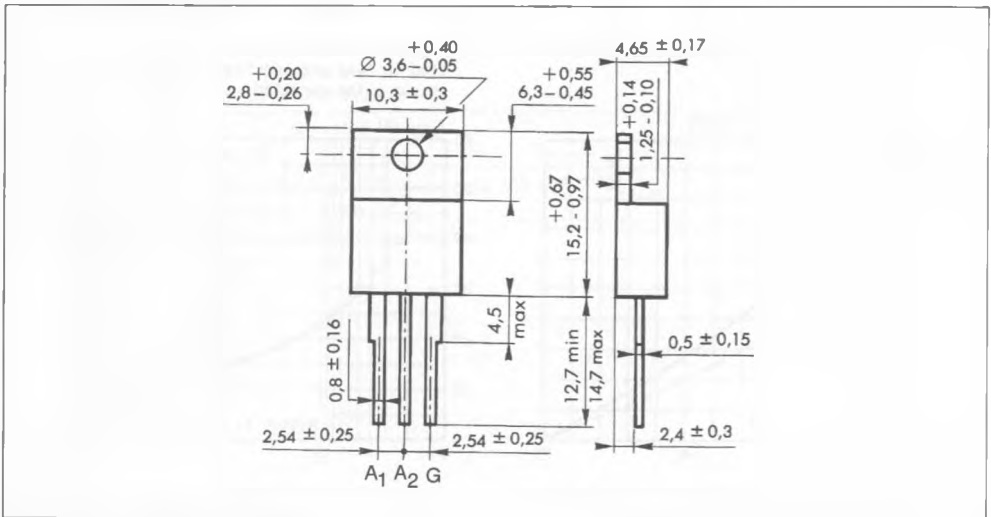

Fig.8 - On-state characteristics (maximum values).

PACKAGE MECHANICAL DATA

TO 220 AB (CB-415) Plastic



Cooling method : by conduction (method C)

Marking : type number

Weight : 2 g