

### Features

- Glass Passivated Die Construction
- Ultra-Fast Switching
- High Current Capability
- Low Reverse Leakage Current
- High Surge Current Capability
- Plastic Material has UL Flammability Classification 94V-O

### Mechanical Data

- Case: ITO-220 Full Molded Plastic
- Terminals: Plated Leads Solderable per MIL-STD-202, Method 208
- Polarity: See Diagram
- Weight: 2.24 grams (approx.)
- Mounting Position: Any
- Marking: Type Number

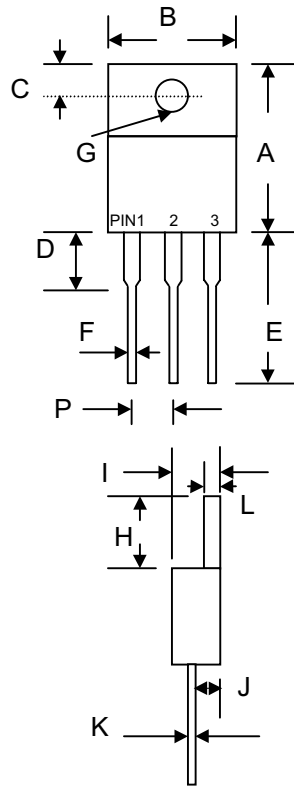

ITO-220		
Dim	Min	Max
A	14.9	15.1
B	—	10.5
C	2.62	2.87
D	3.56	4.06
E	13.46	14.22
F	0.68	0.94
G	3.74 Ø	3.91 Ø
H	5.84	6.86
I	4.44	4.70
J	2.54	2.79
K	0.35	0.64
L	1.14	1.40
P	2.41	2.67
All Dimensions in mm		

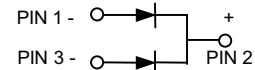

### Maximum Ratings and Electrical Characteristics @ $T_A=25^\circ\text{C}$ unless otherwise specified

Single Phase, half wave, 60Hz, resistive or inductive load.  
 For capacitive load, derate current by 20%.

Characteristic	Symbol	UF 1600FCT	UF 1601FCT	UF 1602FCT	UF 1603FCT	UF 1604FCT	UF 1606FCT	UF 1608FCT	Unit
Peak Repetitive Reverse Voltage	$V_{RRM}$	50	100	200	300	400	600	800	V
Working Peak Reverse Voltage	$V_{RWM}$								
DC Blocking Voltage	$V_R$								
RMS Reverse Voltage	$V_{R(RMS)}$	35	70	140	210	280	420	560	V
Average Rectified Output Current @ $T_C = 105^\circ\text{C}$	$I_O$	16							A
Non-Repetitive Peak Forward Surge Current 8.3ms Single half sine-wave superimposed on rated load (JEDEC Method)	$I_{FSM}$	125							A
Forward Voltage @ $I_F = 8.0\text{A}$	$V_{FM}$	1.0		1.3		1.7		V	
Peak Reverse Current @ $T_A = 25^\circ\text{C}$ At Rated DC Blocking Voltage @ $T_A = 125^\circ\text{C}$	$I_{RM}$	10 500							$\mu\text{A}$
Reverse Recovery Time (Note 1)	$t_{rr}$	50					100		nS
Typical Junction Capacitance (Note 2)	$C_j$	80					50		pF
Operating and Storage Temperature Range	$T_j, T_{STG}$	-65 to +150							$^\circ\text{C}$

Note: 1. Measured with  $I_F = 0.5\text{A}$ ,  $I_R = 1.0\text{A}$ ,  $IRR = 0.25\text{A}$ . See figure 5.  
 2. Measured at 1.0 MHz and applied reverse voltage of 4.0V D.C.

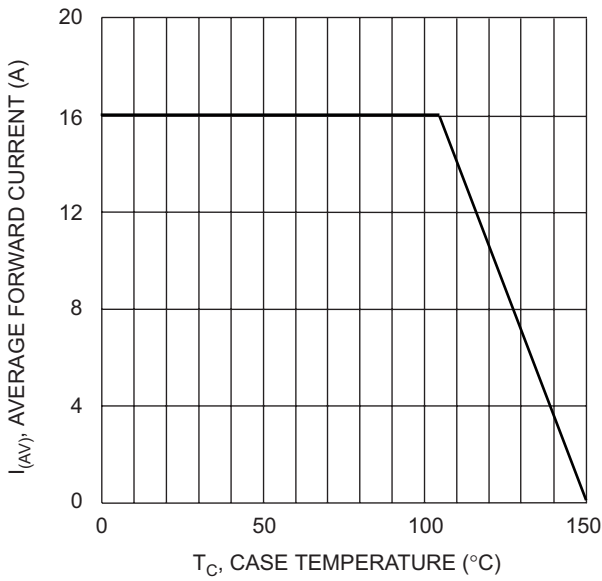

Fig. 1 Forward Current Derating Curve

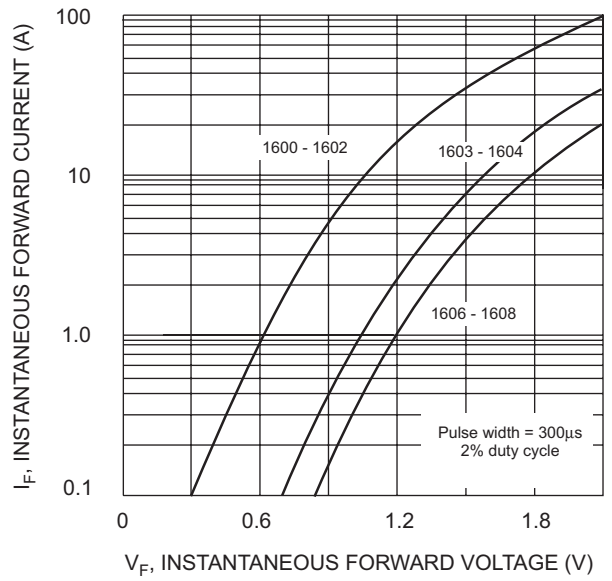

Fig. 2 Typical Forward Characteristics

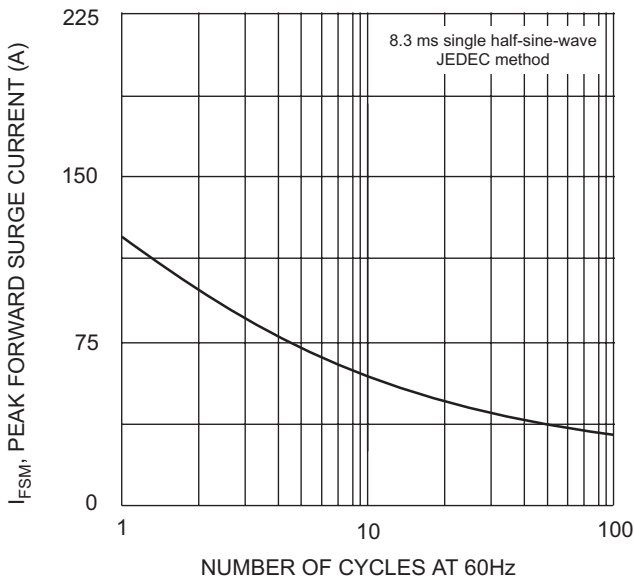

Fig. 3 Maximum Non-Repetitive Surge Current

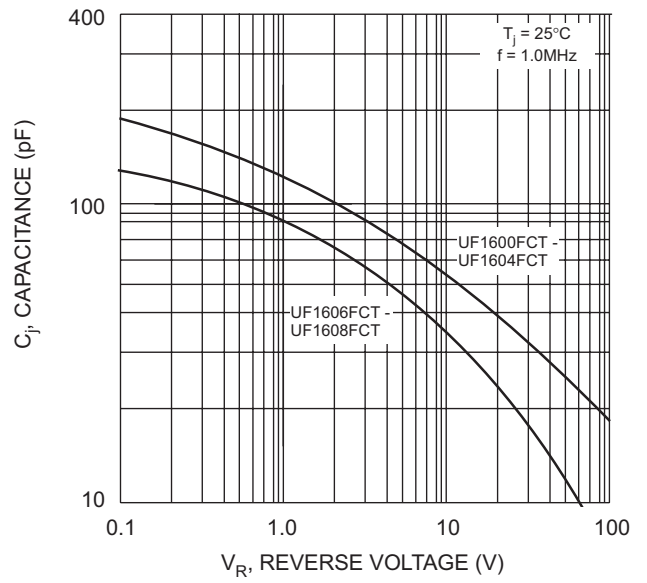
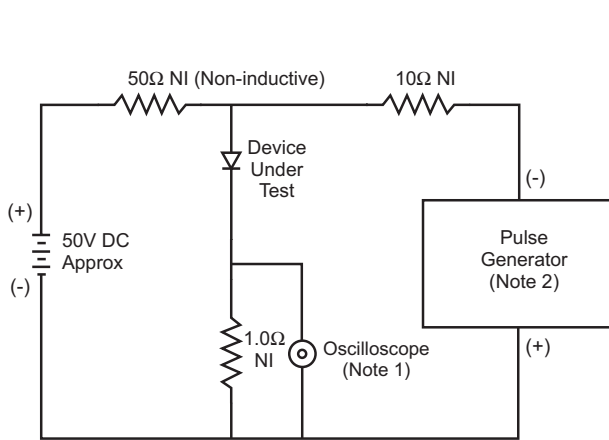
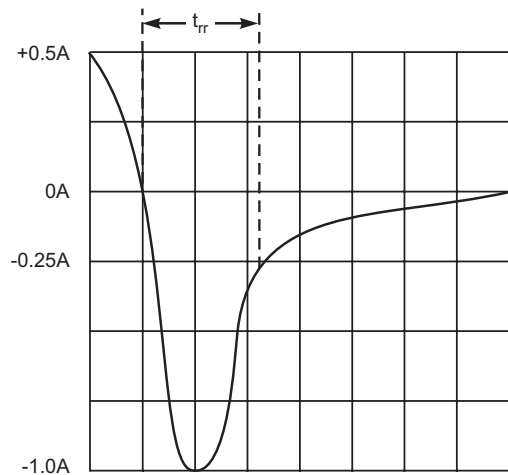

Fig. 4 Typical Junction Capacitance



- Notes:
1. Rise Time = 7.0ns max. Input Impedance = 1.0MΩ, 22pF.
  2. Rise Time = 10ns max. Input Impedance = 50Ω.



Set time base for 5/10ns/cm

Fig. 5 Reverse Recovery Time Characteristic and Test Circuit