



# STTH803D/G

## HIGH FREQUENCY SECONDARY RECTIFIER

### MAJOR PRODUCTS CHARACTERISTICS

<b>I<sub>F(AV)</sub></b>	<b>8 A</b>
<b>V<sub>RRM</sub></b>	<b>300 V</b>
<b>T<sub>j</sub> (max)</b>	<b>175 °C</b>
<b>V<sub>F</sub> (max)</b>	<b>1 V</b>
<b>trr (max)</b>	<b>35 ns</b>

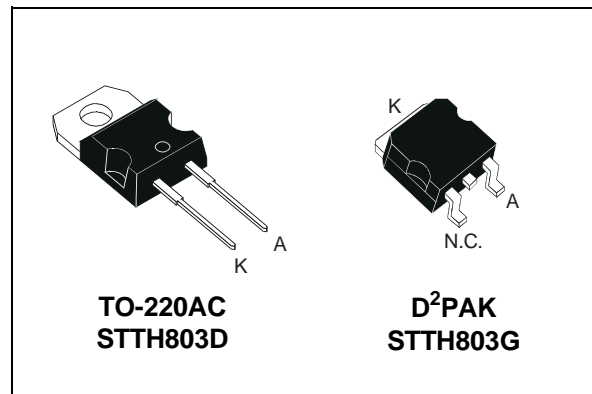
### FEATURES AND BENEFITS

- COMBINES HIGHEST RECOVERY AND REVERSE VOLTAGE PERFORMANCE
- ULTRAFAST, SOFT AND NOISE-FREE RECOVERY FOR LOW SIDE EFFECTS

### DESCRIPTION

Single Fast Recovery Epitaxial Diode suited for Switch Mode Power Supply and high frequency DC/DC converters.

Packaged in TO-220AC or D<sup>2</sup>PAK this device is especially intended for secondary rectification.



### ABSOLUTE RATINGS (limiting values)

Symbol	Parameter		Value	Unit
V <sub>RRM</sub>	Repetitive peak reverse voltage		300	V
I <sub>F(RMS)</sub>	RMS forward current		20	A
I <sub>F(AV)</sub>	Average forward current	T <sub>c</sub> = 150°C δ = 0.5	8	A
I <sub>FSM</sub>	Surge non repetitive forward current	t <sub>p</sub> = 10 ms sinusoidal	100	A
I <sub>RSM</sub>	Non repetitive avalanche current	t <sub>p</sub> = 20 μs square	4	A
T <sub>stg</sub>	Storage temperature range		-65 +175	°C
T <sub>j</sub>	Maximum operating junction temperature		+ 175	°C

## STTH803D/G

### THERMAL RESISTANCES

Symbol	Parameter	Value	Unit
$R_{th(j-c)}$	Junction to case	2.5	°C/W

### STATIC ELECTRICAL CHARACTERISTICS (per diode)

Symbol	Parameter	Tests conditions		Min.	Typ.	Max.	Unit
$I_R^*$	Reverse leakage current	$V_R = 300\text{ V}$	$T_j = 25^\circ\text{C}$			20	$\mu\text{A}$
			$T_j = 125^\circ\text{C}$		20	200	
$V_F^{**}$	Forward voltage drop	$I_F = 8\text{ A}$	$T_j = 25^\circ\text{C}$			1.25	V
		$I_F = 8\text{ A}$	$T_j = 125^\circ\text{C}$		0.85	1	

Pulse test : \*  $t_p = 5\text{ ms}$ ,  $\delta < 2\%$

\*\*  $t_p = 380\ \mu\text{s}$ ,  $\delta < 2\%$

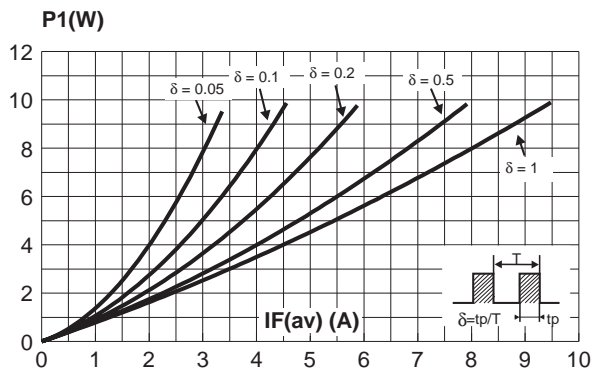
To evaluate the maximum conduction losses use the following equation :

$$P = 0.75 \times I_{F(AV)} + 0.031 I_{F(RMS)}^2$$

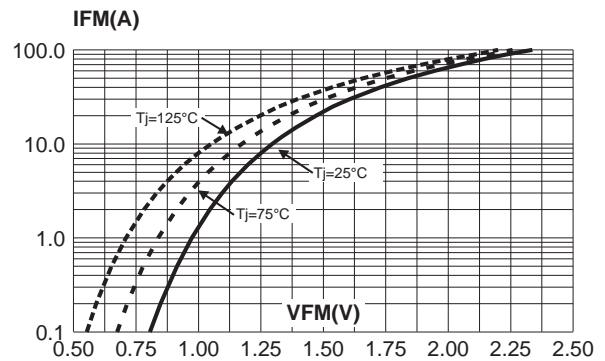
### RECOVERY CHARACTERISTICS

Symbol	Tests conditions			Min.	Typ.	Max.	Unit
trr	$I_F = 0.5\text{ A}$	$I_{rr} = 0.25\text{ A}$	$I_R = 1\text{ A}$	$T_j = 25^\circ\text{C}$		25	ns
	$I_F = 1\text{ A}$	$di_F/dt = -50\text{ A}/\mu\text{s}$	$V_R = 30\text{ V}$				
tfr	$I_F = 8\text{ A}$	$di_F/dt = 100\text{ A}/\mu\text{s}$		$T_j = 25^\circ\text{C}$		200	ns
$V_{FP}$	$V_{FR} = 1.1 \times V_F \text{ max.}$			$T_j = 25^\circ\text{C}$		3.5	V
$S_{factor}$	$V_{CC} = 200\text{ V}$	$I_F = 8\text{ A}$		$T_j = 125^\circ\text{C}$	0.3	8	-
$I_{RM}$	$di_F/dt = 200\text{ A}/\mu\text{s}$						

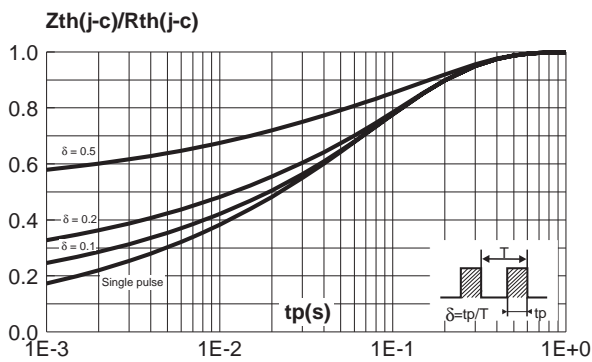
**Fig. 1:** Conduction losses versus average current.



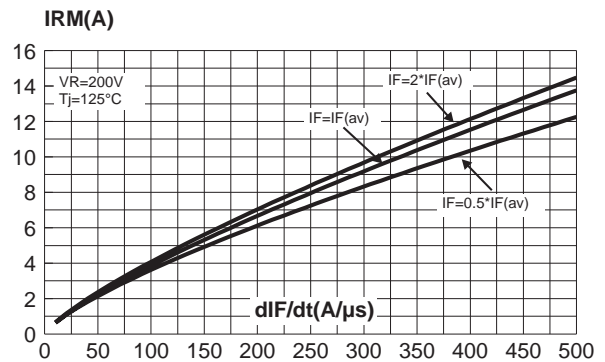
**Fig. 2:** Forward voltage drop versus forward current (maximum values).



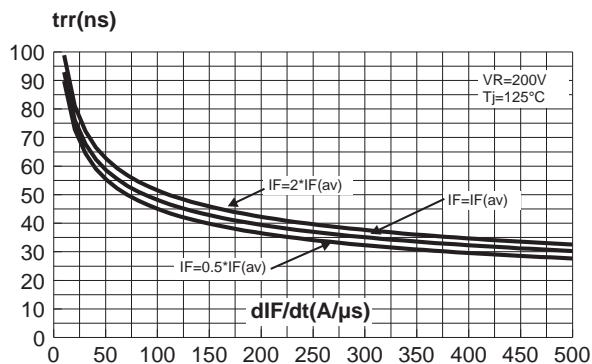
**Fig. 3:** Relative variation of thermal impedance junction to case versus pulse duration.



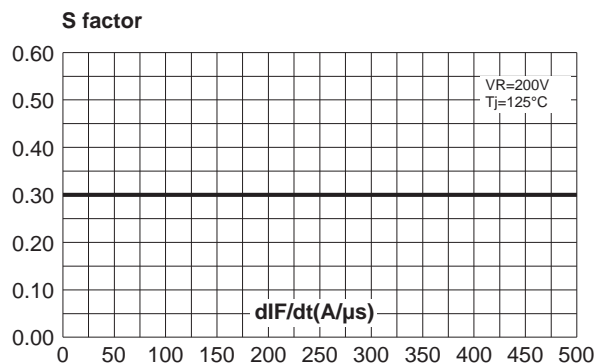
**Fig. 4:** Peak reverse recovery current versus dIF/dt (90% confidence).



**Fig. 5:** Reverse recovery time versus dIF/dt (90% confidence).

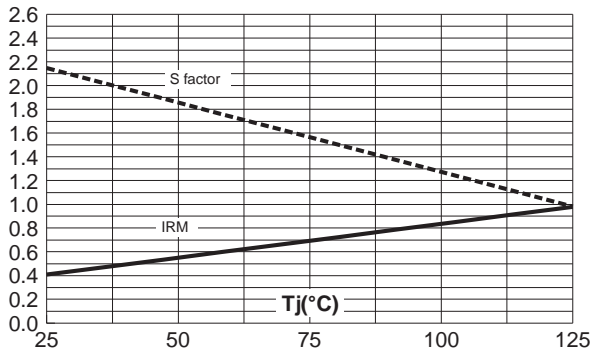


**Fig. 6:** Softness factor versus dIF/dt (typical values).

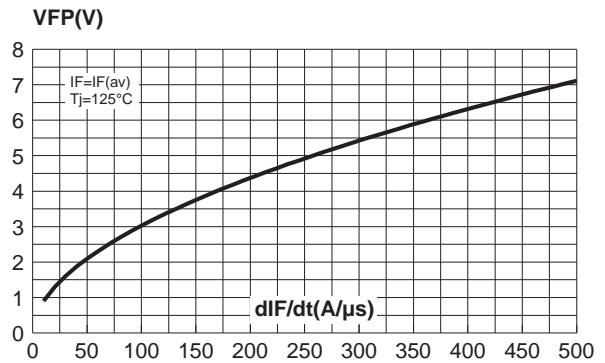


## STTH803D/G

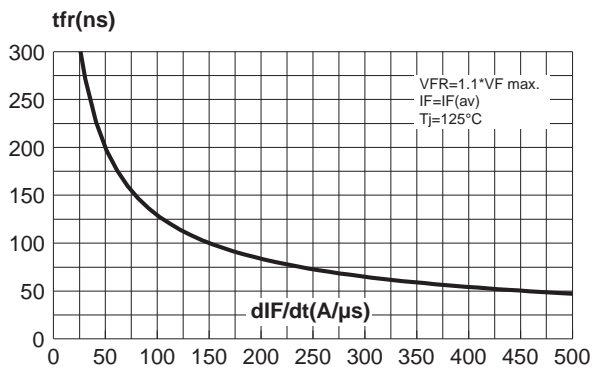
**Fig. 7:** Relative variation of dynamic parameters versus junction temperature (reference:  $T_j = 125^\circ\text{C}$ ).



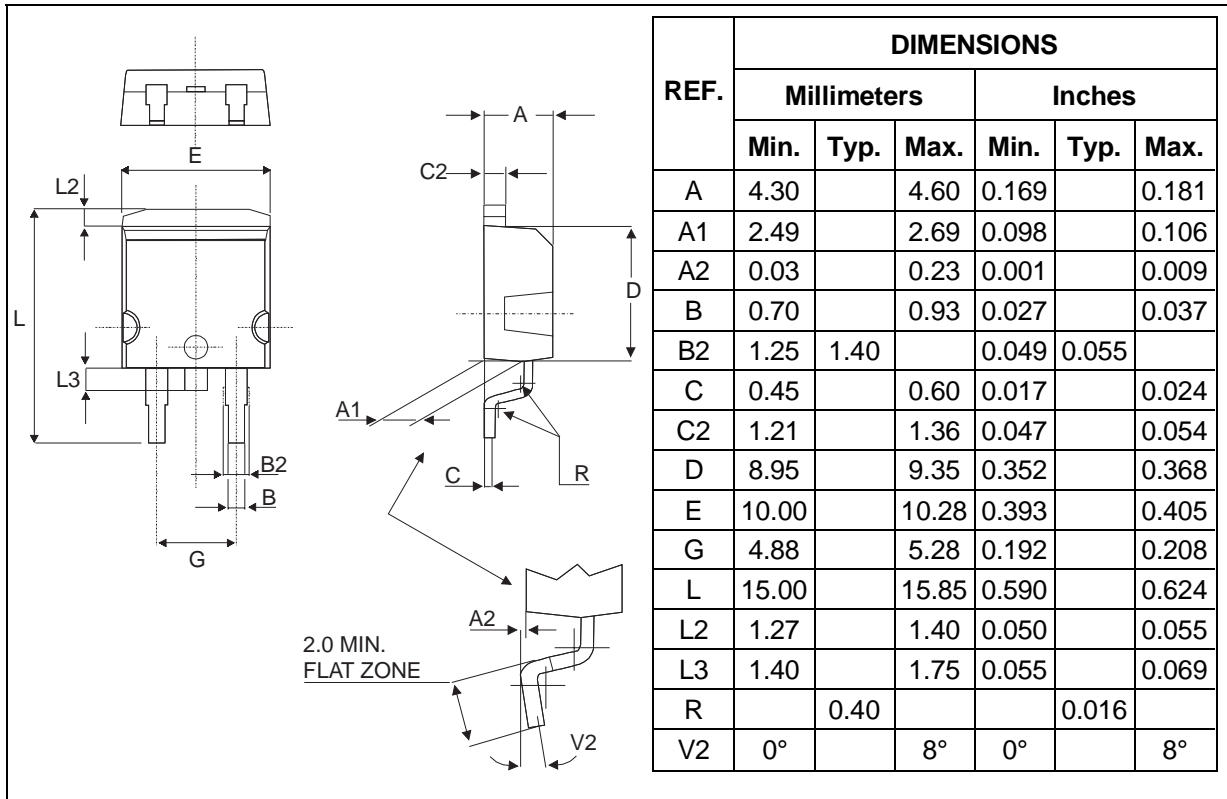
**Fig. 8:** Transient peak forward voltage versus  $dI_F/dt$  (90% confidence).



**Fig. 9:** Forward recovery time versus  $dI_F/dt$  (90% confidence).

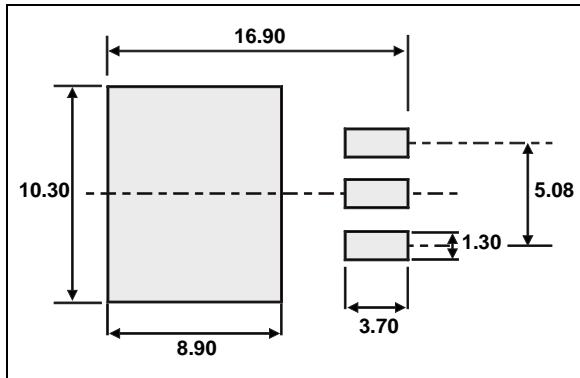


**PACKAGE MECHANICAL DATA**  
D<sup>2</sup>PAK



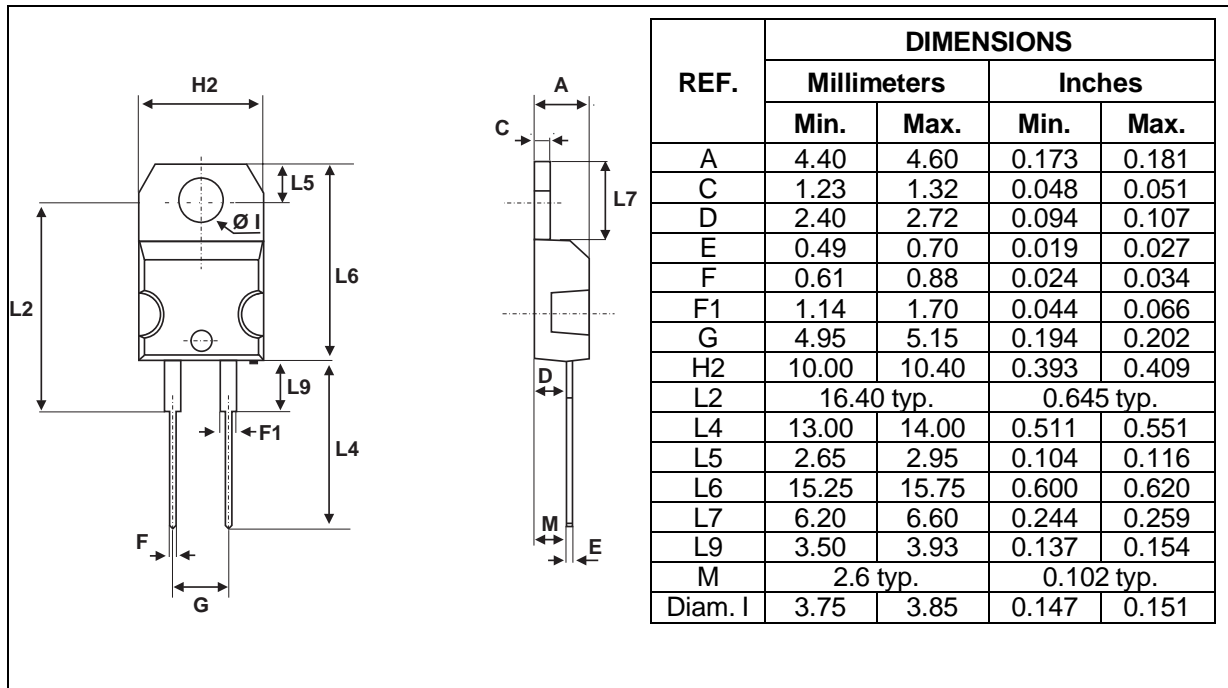
**FOOT PRINT DIMENSIONS (in millimeters)**  
D<sup>2</sup>PAK

■ Cooling method : C



## STTH803D/G

### PACKAGE MECHANICAL DATA TO-220AC



- Cooling method : by conduction (C)
- Recommended torque value : 0.55 m.N
- Maximum torque value : 0.70 m.N

Ordering code	Marking	Package	Weight	Base qty	Delivery mode
STTH803D	STTH803D	TO-220AC	1.86g	50	Tube
STTH803G	STTH803G	D <sup>2</sup> PAK	1.48g	50	Tube

- Epoxy meets UL 94,V0

Information furnished is believed to be accurate and reliable. However, STMicroelectronics assumes no responsibility for the consequences of use of such information nor for any infringement of patents or other rights of third parties which may result from its use. No license is granted by implication or otherwise under any patent or patent rights of STMicroelectronics. Specifications mentioned in this publication are subject to change without notice. This publication supersedes and replaces all information previously supplied. STMicroelectronics products are not authorized for use as critical components in life support devices or systems without express written approval of STMicroelectronics.

The ST logo is a registered trademark of STMicroelectronics

© 1998 STMicroelectronics - Printed in Italy - All rights reserved.

STMicroelectronics GROUP OF COMPANIES

Australia - Brazil - Canada - China - France - Germany - Italy - Japan - Korea - Malaysia - Malta - Mexico - Morocco - The Netherlands - Singapore - Spain - Sweden - Switzerland - Taiwan - Thailand - United Kingdom - U.S.A.

<http://www.st.com>