

Diode Modules

$I_{FRMS} = 2 \times 100 \text{ A}$
 $I_{FAVM} = 2 \times 64 \text{ A}$
 $V_{RRM} = 800-1800 \text{ V}$

V_{RSM} V	V_{RRM} V	Type
900	800	MDD 44-08N1 B
1300	1200	MDD 44-12N1 B
1500	1400	MDD 44-14N1 B
1700	1600	MDD 44-16N1 B
1900	1800	MDD 44-18N1 B

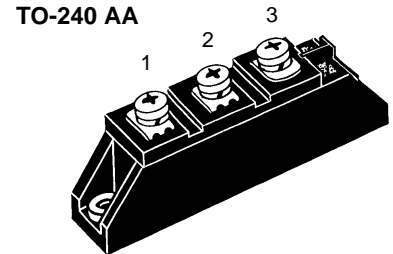
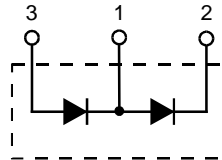

Symbol	Test Conditions	Maximum Ratings		
I_{FRMS} I_{FAVM}	$T_{VJ} = T_{VJM}$	100	A	
	$T_C = 92^\circ\text{C}; 180^\circ \text{ sine}$	64	A	
	$T_C = 100^\circ\text{C}; 180^\circ \text{ sine}$	59	A	
I_{FSM}	$T_{VJ} = 45^\circ\text{C};$ $V_R = 0$	t = 10 ms (50 Hz), sine	1150	A
		t = 8.3 ms (60 Hz), sine	1300	A
	$T_{VJ} = T_{VJM}$ $V_R = 0$	t = 10 ms (50 Hz), sine	1000	A
		t = 8.3 ms (60 Hz), sine	1200	A
$\int i^2 dt$	$T_{VJ} = 45^\circ\text{C}$ $V_R = 0$	t = 10 ms (50 Hz), sine	6600	A ² s
		t = 8.3 ms (60 Hz), sine	7000	A ² s
	$T_{VJ} = T_{VJM}$ $V_R = 0$	t = 10 ms (50 Hz), sine	5000	A ² s
		t = 8.3 ms (60 Hz), sine	5950	A ² s
T_{VJ}		-40...+150	°C	
T_{VJM}		150	°C	
T_{stg}		-40...+125	°C	
V_{ISOL}	50/60 Hz, RMS	t = 1 min	3000	V~
	$I_{ISOL} \leq 1 \text{ mA}$	t = 1 s	3600	V~
M_d	Mounting torque (M5)		2.5-4/22-35	Nm/lb.in.
	Terminal connection torque (M5)		2.5-4/22-35	Nm/lb.in.
Weight	Typical including screws		90	g

Features

- International standard package JEDEC TO-240 AA
- Direct copper bonded Al₂O₃ -ceramic base plate
- Planar passivated chips
- Isolation voltage 3600 V~
- UL registered, E 72873

Applications

- Supplies for DC power equipment
- DC supply for PWM inverter
- Field supply for DC motors
- Battery DC power supplies

Advantages

- Space and weight savings
- Simple mounting
- Improved temperature and power cycling
- Reduced protection circuits

Dimensions in mm (1 mm = 0.0394")

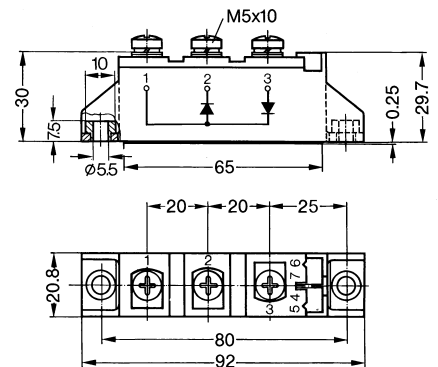

Symbol	Test Conditions	Characteristic Values		
I_R	$T_{VJ} = T_{VJM}; V_R = V_{RRM}$	10	mA	
V_F	$I_F = 200 \text{ A}; T_{VJ} = 25^\circ\text{C}$	1.60	V	
V_{T0}	For power-loss calculations only	0.8	V	
r_T	$T_{VJ} = T_{VJM}$	4.3	mΩ	
Q_S	$T_{VJ} = 125^\circ\text{C}; I_F = 50 \text{ A}, -di/dt = 0.64 \text{ A}/\mu\text{s}$	90	μC	
I_{RM}		11	A	
R_{thJC}	per diode; DC current per module	} other values see Fig. 6/7	0.59	K/W
			0.295	K/W
R_{thJK}	per diode; DC current per module	}	0.79	K/W
			0.395	K/W
d_s	Creepage distance on surface	12.7	mm	
d_A	Strike distance through air	9.6	mm	
a	Maximum allowable acceleration	50	m/s ²	

Data according to IEC 60747 and refer to a single diode unless otherwise stated. IXYS reserves the right to change limits, test conditions and dimensions

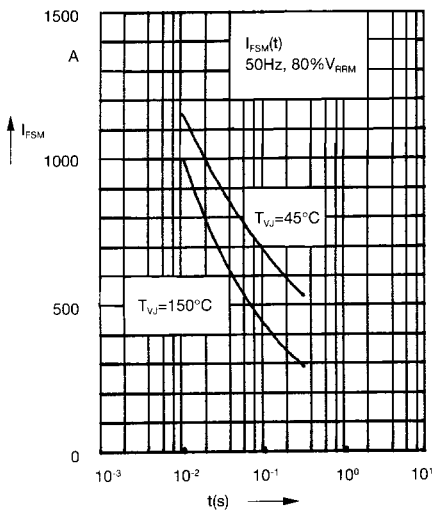

Fig. 1 Surge overload current
 I_{FSM} : Crest value, t : duration

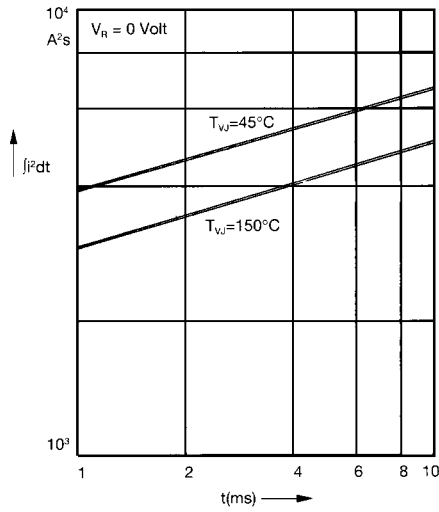

Fig. 2 $\int i^2 dt$ versus time (1-10 ms)

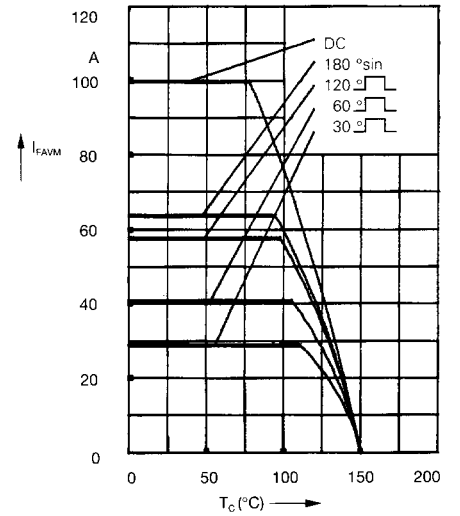

Fig. 2a Maximum forward current at case temperature

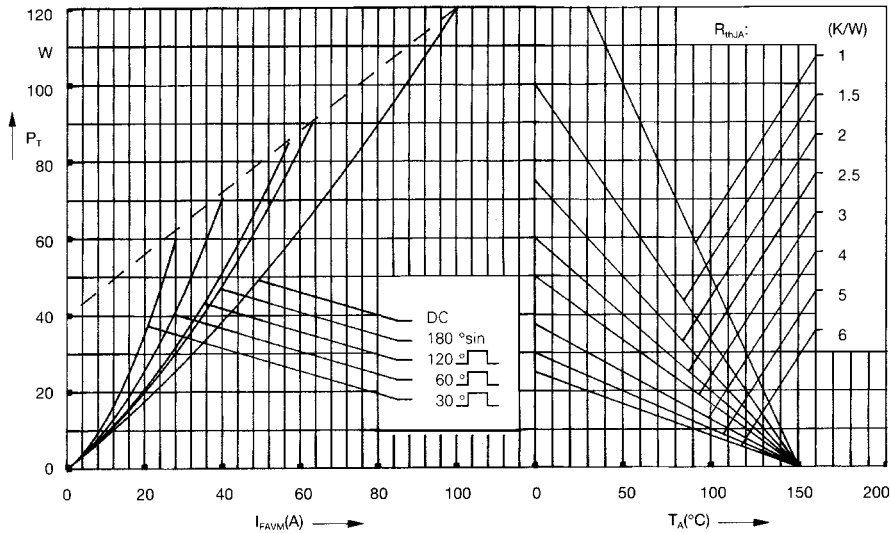

Fig. 3 Power dissipation versus forward current and ambient temperature (per diode)

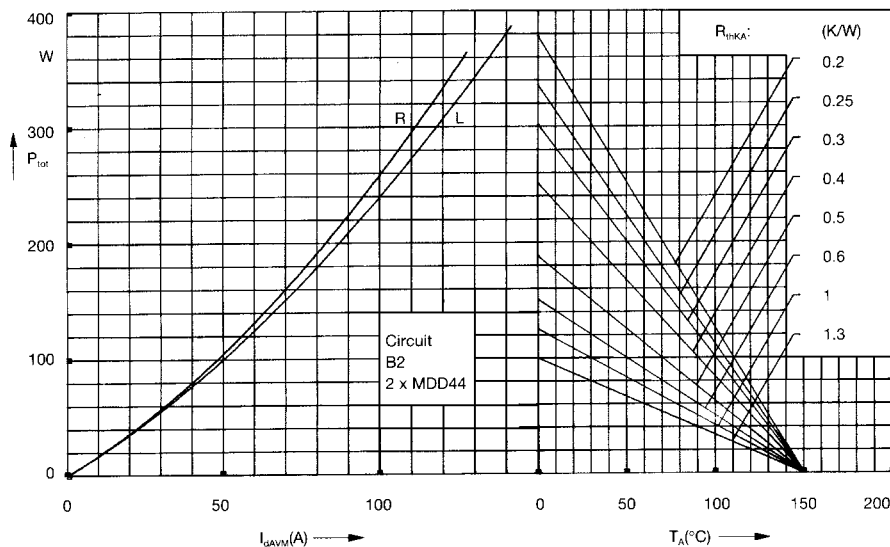

Fig. 4 Single phase rectifier bridge:
 Power dissipation versus direct output current and ambient temperature
 R = resistive load
 L = inductive load

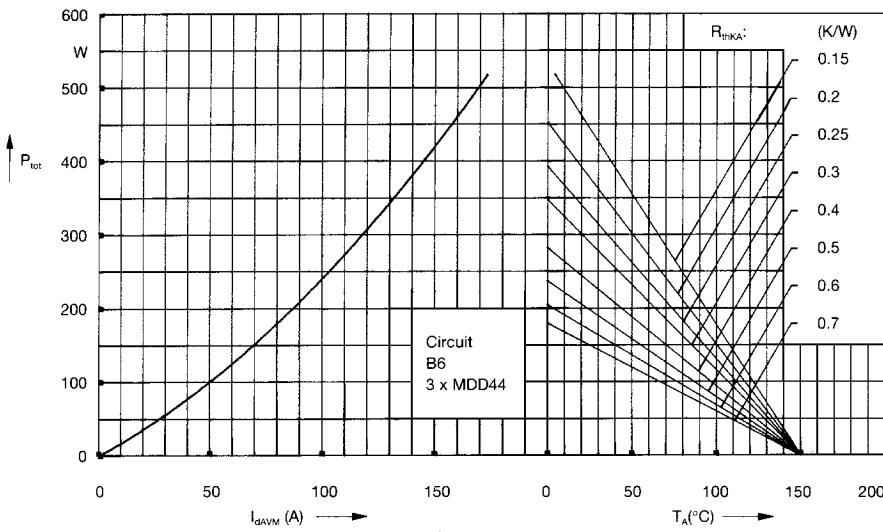

Fig. 5 Three phase rectifier bridge: Power dissipation versus direct output current and ambient temperature

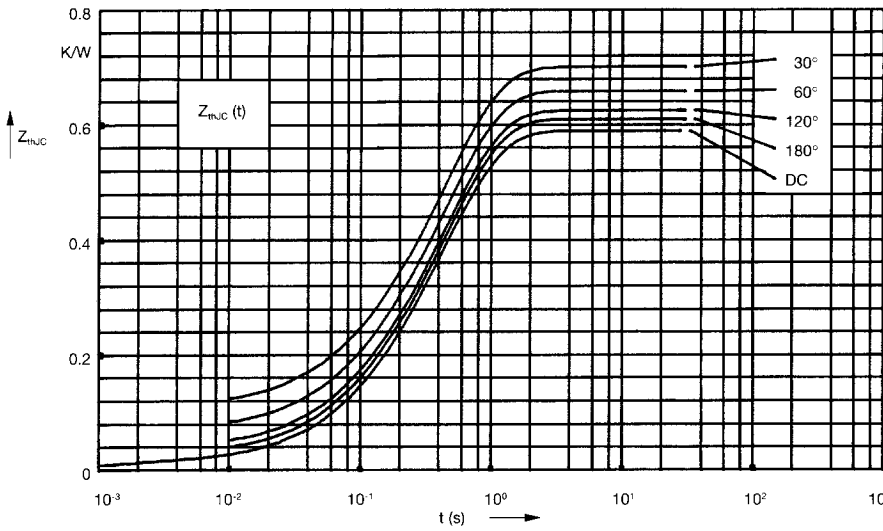

Fig. 6 Transient thermal impedance junction to case (per diode)

R_{thJC} for various conduction angles d:

d	R_{thJC} (K/W)
DC	0.59
180°	0.61
120°	0.63
60°	0.66
30°	0.70

Constants for Z_{thJC} calculation:

i	R_{thi} (K/W)	t_i (s)
1	0.012	0.0012
2	0.045	0.095
3	0.533	0.455

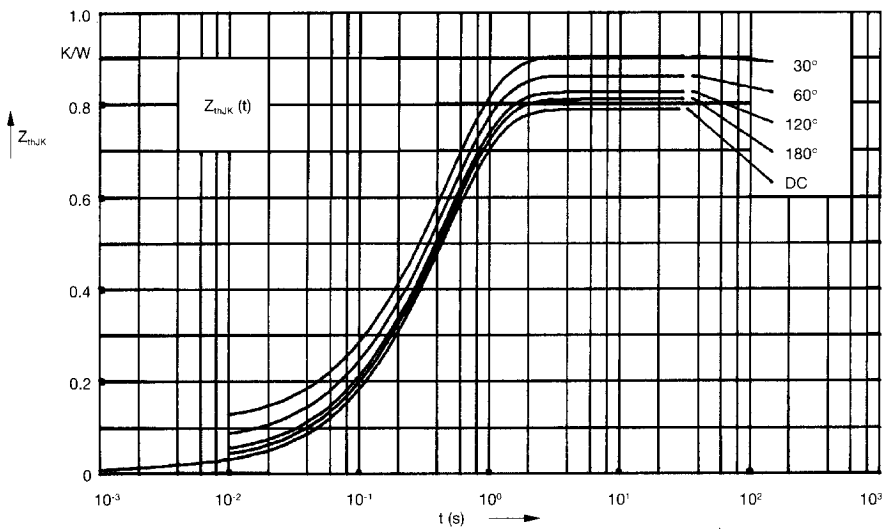

Fig. 7 Transient thermal impedance junction to heatsink (per diode)

R_{thJK} for various conduction angles d:

d	R_{thJK} (K/W)
DC	0.79
180°	0.81
120°	0.83
60°	0.86
30°	0.90

Constants for Z_{thJK} calculation:

i	R_{thi} (K/W)	t_i (s)
1	0.012	0.0012
2	0.045	0.095
3	0.533	0.455
4	0.2	0.495