

STANDARD RECOVERY DIODES

Stud Version

Features

- High surge current capability
- Designed for a wide range of applications
- Stud cathode and stud anode version
- Leaded version available
- Types up to 1600V V_{RRM}

70 A

Typical Applications

- Battery charges
- Converters
- Power supplies
- Machine tool controls

Major Ratings and Characteristics

Parameters	70HF(R)		Units
	10 to 120	140 to 160	
$I_{F(AV)}$	70	70	A
@ T_C	140	110	°C
$I_{F(RMS)}$	110		A
I_{FSM}	@ 50Hz	1200	A
	@ 60Hz	1250	A
I^2t	@ 50Hz	7100	A ² s
	@ 60Hz	6540	A ² s
V_{RRM} range	100 to 1200	1400 to 1600	V
T_J range	- 65 to 180	- 65 to 150	°C

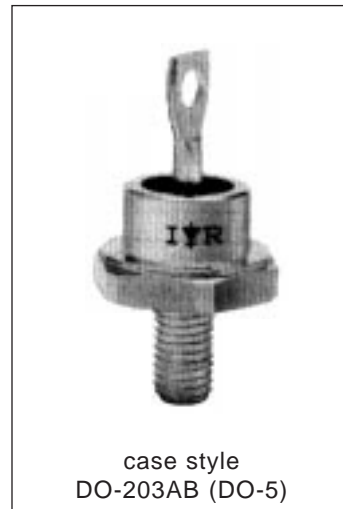

70HF(R) Series

Bulletin I20202 rev. A 05/98

International
 Rectifier

ELECTRICAL SPECIFICATIONS

Voltage Ratings

Type number	Voltage Code	V_{RRM} : maximum repetitive peak reverse voltage V	V_{RSM} : maximum non-repetitive peak reverse voltage V	$V_{R(BR)}$: minimum avalanche voltage V (1)	I_{RRM} max. @ $T_J = T_J$ max. mA
70HF(R)	10	100	200	--	15
	20	200	300	--	
	40	400	500	500	
	60	600	720	725	9
	80	800	960	950	
	100	1000	1200	1150	
	120	1200	1440	1350	
	140	1400	1650	1550	4.5
160	1600	1900	1750		

(1) Avalanche version only available from V_{RRM} 400V to 1600V.

Forward Conduction

Parameter	70HF(R)		Units	Conditions	
	10 to 120	140 to 160			
$I_{F(AV)}$ Max. average forward current @ Case temperature	70	70	A	180° conduction, half sine wave	
	140	110	°C		
$I_{F(RMS)}$ Max. RMS forward current	110		A	DC @ $T_C = 25^\circ\text{C}$	
P_R Maximum non-repetitive peak reverse power	20		K · W	10µs square pulse, $T_J = T_J$ max. see note (2)	
I_{FSM} Max. peak, one-cycle forward, non-repetitive surge current	1200		A	t = 10ms	Sinusoidal half wave, Initial $T_J = T_J$ max.
	1250			No voltage reappplied	
	1000			100% V_{RRM} reappplied	
	1050			100% V_{RRM} reappplied	
I^2t Maximum I^2t for fusing	7100		A ² s	t = 10ms	Initial $T_J = T_J$ max.
	6450			No voltage reappplied	
	5000			100% V_{RRM} reappplied	
	4550			100% V_{RRM} reappplied	
$I^2\sqrt{t}$ Maximum $I^2\sqrt{t}$ for fusing	71000		A ² √s	t = 0.1 to 10ms, no voltage reappplied	
$V_{F(TO)1}$ Low level value of threshold voltage	0.79		V	(16.7% × π × $I_{F(AV)}$ < I < π × $I_{F(AV)}$), $T_J = T_J$ max.	
$V_{F(TO)2}$ High level value of threshold voltage	1.00			(I > π × $I_{F(AV)}$), $T_J = T_J$ max.	
r_{f1} Low level value of forward slope resistance	2.33		mΩ	(16.7% × π × $I_{F(AV)}$ < I < π × $I_{F(AV)}$), $T_J = T_J$ max.	
r_{f2} High level value of forward slope resistance	1.53			(I > π × $I_{F(AV)}$), $T_J = T_J$ max.	
V_{FM} Max. forward voltage drop	1.35		V	$I_{pk} = 220\text{A}$, $T_J = 25^\circ\text{C}$, $t_p = 10\text{ms}$ sinusoidal wave	

(2) Available only for Avalanche version, all other parameters the same as 70HF.

Thermal and Mechanical Specifications

Parameter	70HF(R)		Units	Conditions
	10 to 120	140 to 160		
T _J Max. junction operating temperature range	-65 to 180	-65 to 150	°C	
T _{stg} Max. storage temperature range	-65 to 180	-65 to 150		
R _{thJC} Max. thermal resistance, junction to case	0.45		K/W	DC operation
R _{thCS} Max. thermal resistance, case to heatsink	0.25			Mounting surface, smooth, flat and greased
T Max. allowed mounting torque ±10%	2.3 - 3.4		Nm	Not lubricated threads
	20 - 30		lbf·in	
wt Approximate weight	17 (0.6)		g (oz)	
Case style	DO-203AB (DO5)			See Outline Table

ΔR_{thJC} Conduction

(The following table shows the increment of thermal resistance R_{thJC} when devices operate at different conduction angles than DC)

Conduction angle	Sinusoidal conduction	Rectangular conduction	Units	Conditions
180°	0.08	0.06	K/W	T _J = T _J max.
120°	0.10	0.11		
90°	0.13	0.14		
60°	0.19	0.20		
30°	0.30	0.30		

Ordering Information Table

Device Code											
	<table border="1" style="margin: auto;"> <tr> <td style="padding: 5px;">70</td> <td style="padding: 5px;">HF</td> <td style="padding: 5px;">R</td> <td style="padding: 5px;">160</td> <td style="padding: 5px;">M</td> </tr> <tr> <td style="text-align: center;">①</td> <td style="text-align: center;">②</td> <td style="text-align: center;">③</td> <td style="text-align: center;">④</td> <td style="text-align: center;">⑤</td> </tr> </table>	70	HF	R	160	M	①	②	③	④	⑤
70	HF	R	160	M							
①	②	③	④	⑤							
<p>1 - 70 = Standard device 71 = Not isolated lead 72 = Isolated lead with silicone sleeve (Red = Reverse polarity) (Blue = Normal polarity)</p>											
<p>2 - HF = Standard diode HA = Avalanche diode</p>											
<p>3 - None = Stud Normal Polarity (Cathode to Stud) R = Stud Reverse Polarity (Anode to Stud)</p>											
<p>4 - Voltage code: Code x 10 = V_{RRM} (See Voltage Ratings table)</p>											
<p>5 - None = Stud base DO-203AB (DO-5) 1/4" 28UNF-2A M = Stud base DO-203AB (DO-5) M6 X 1 - (Not available for Avalanche diodes)</p>											

70HF(R) Series

Bulletin I20202 rev. A 05/98

Outlines Table

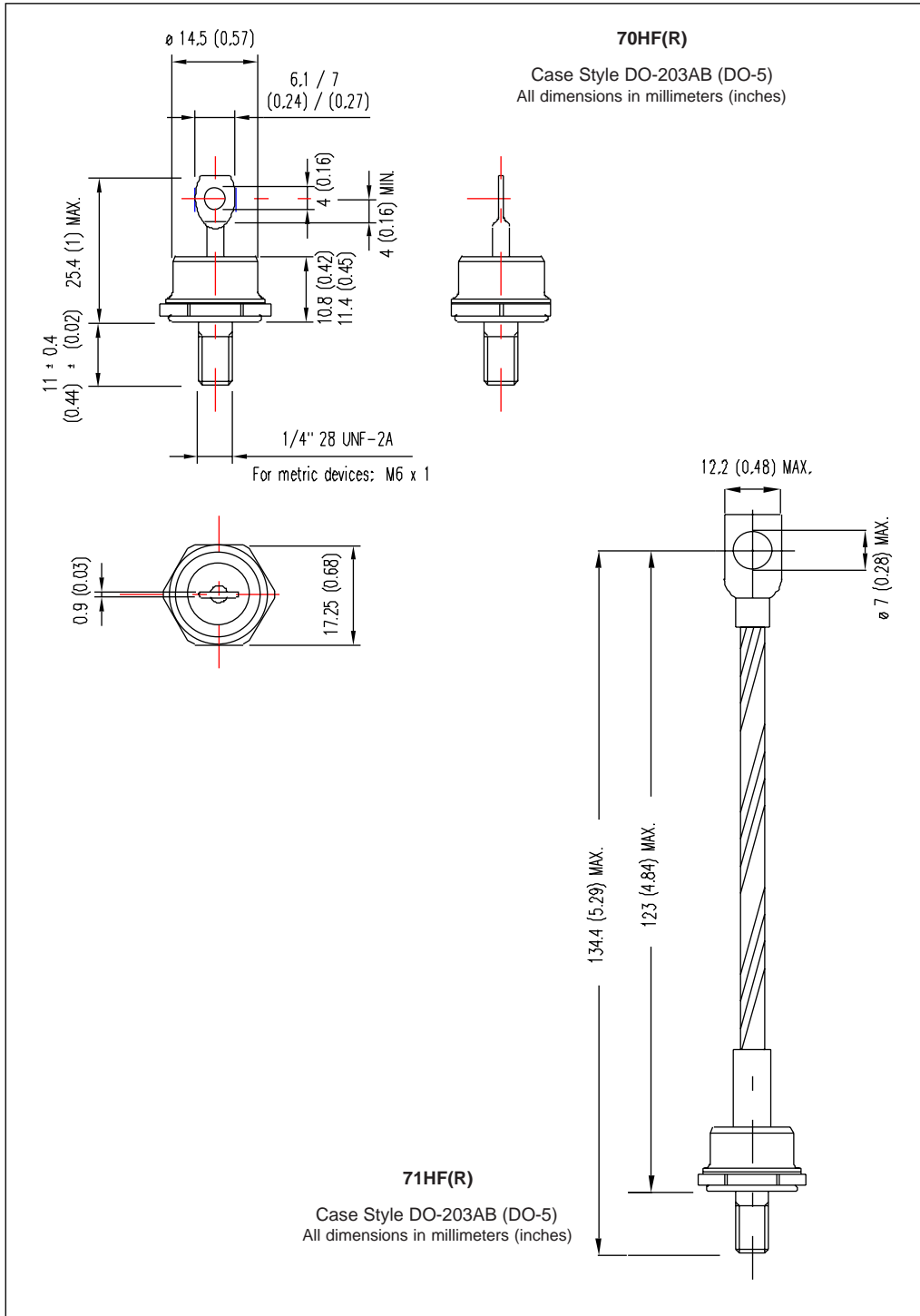

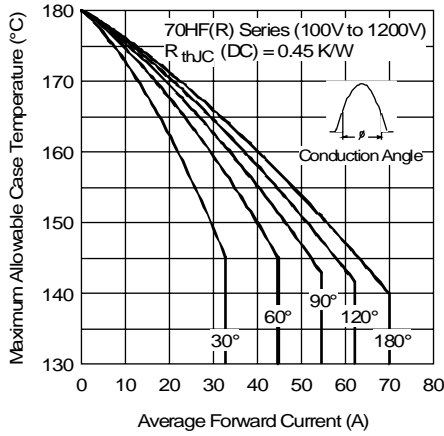

Fig. 1 - Current Ratings Characteristics

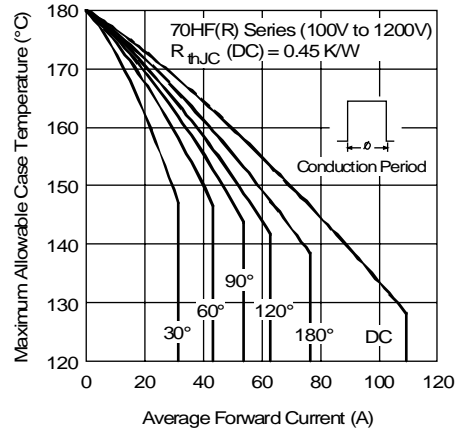

Fig. 2 - Current Ratings Characteristics

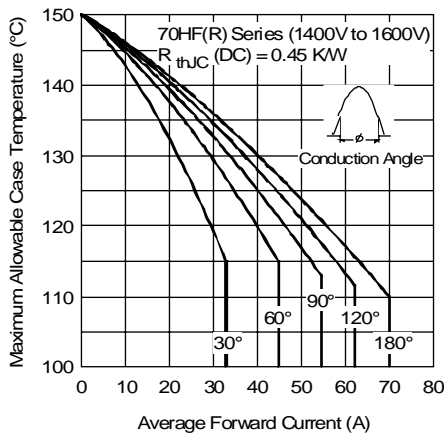

Fig. 3 - Current Ratings Characteristics

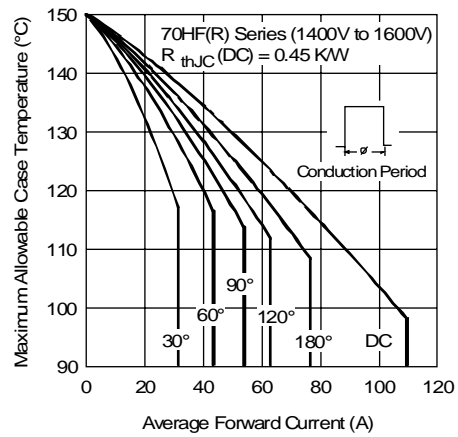

Fig. 4 - Current Ratings Characteristics

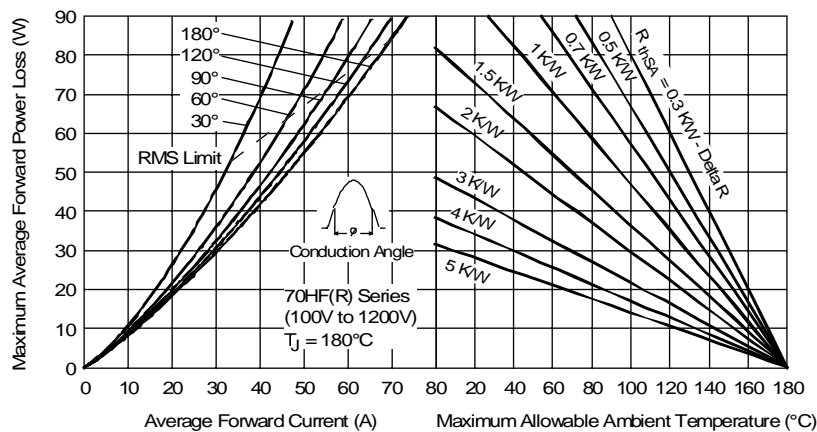

Fig. 5 - Forward Power Loss Characteristics

70HF(R) Series

Bulletin I20202 rev. A 05/98

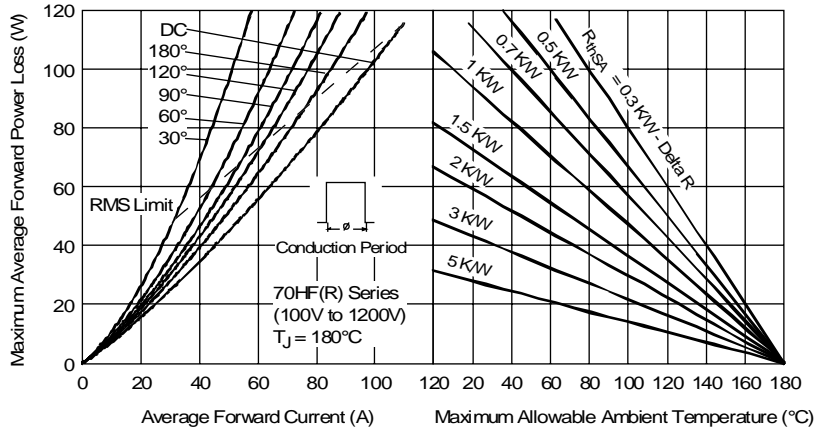

Fig. 6 - Forward Power Loss Characteristics

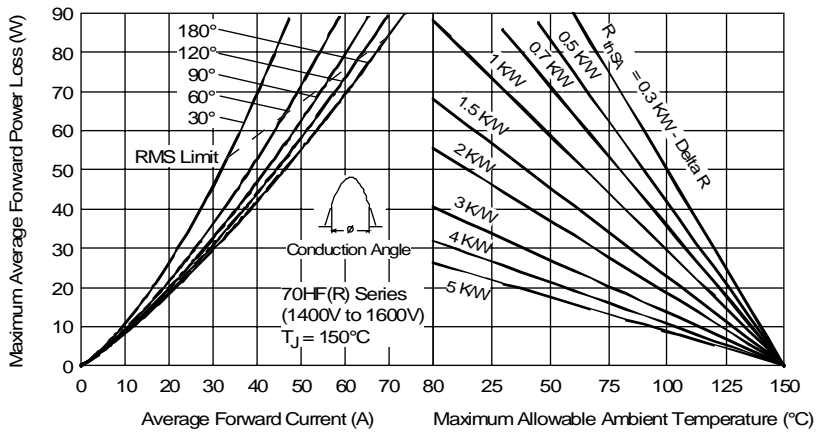

Fig. 7 - Forward Power Loss Characteristics

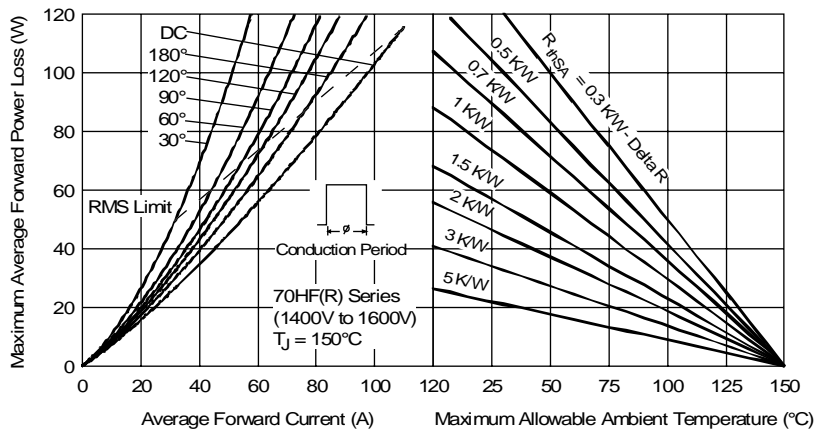

Fig. 8 - Forward Power Loss Characteristics

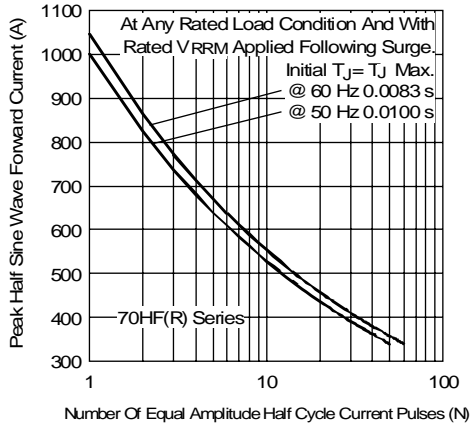

Fig. 9 - Maximum Non-Repetitive Surge Current

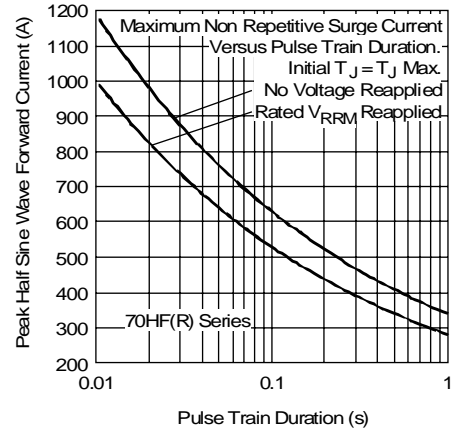

Fig. 10 - Maximum Non-Repetitive Surge Current

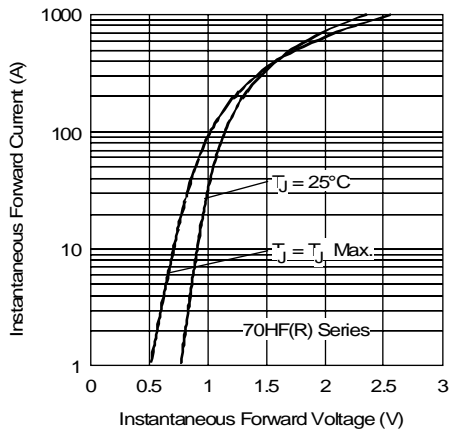

Fig. 11 - Forward Voltage Drop Characteristics

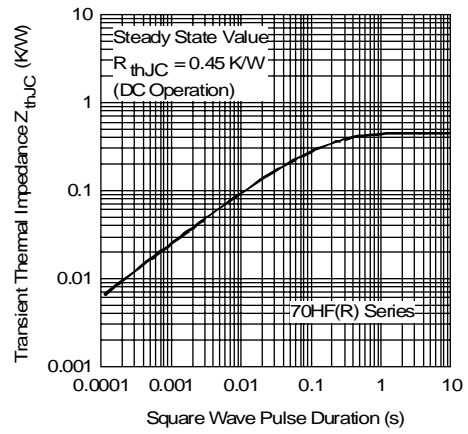

Fig. 12 - Thermal Impedance Z_{thJC} Characteristics