

DATA SHEET

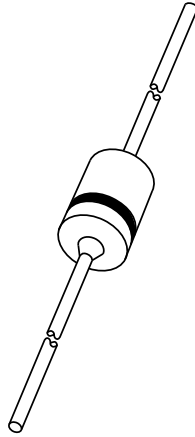

1N4150; 1N4151; 1N4153 High-speed diodes

Product specification
Supersedes data of April 1992
File under Discrete Semiconductors, SC01

1996 Apr 19

High-speed diodes

1N4150; 1N4151; 1N4153

FEATURES

- Hermetically sealed leaded glass SOD27 (DO-35) package
- High switching speed: max. 4 ns
- General application
- Continuous reverse voltage: max. 50 V
- Repetitive peak reverse voltage: max. 75 V
- Repetitive peak forward current: max. 600 mA and 450 mA respectively
- Forward voltage: max. 1 V.

APPLICATIONS

- High-speed switching
- 1N4150: general purpose use in computer and industrial applications
- 1N4151 and 1N4153: military and industrial applications.

DESCRIPTION

The 1N4150, 1N4151, 1N4153 are high-speed switching diodes fabricated in planar technology, and encapsulated in hermetically sealed leaded glass SOD27 (DO-35) packages.

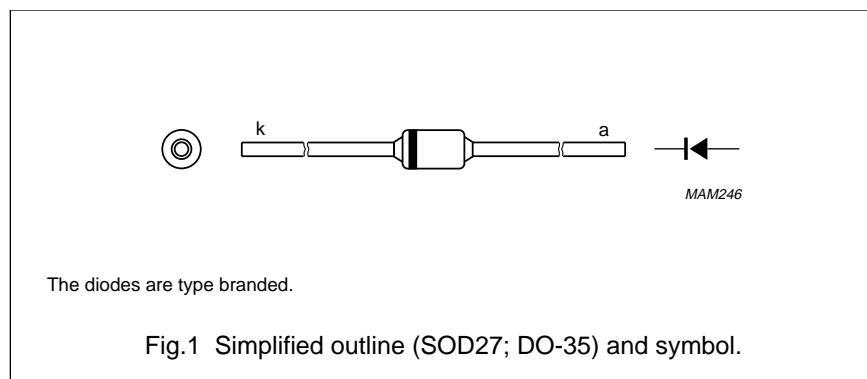

Fig.1 Simplified outline (SOD27; DO-35) and symbol.

High-speed diodes

1N4150; 1N4151; 1N4153

LIMITING VALUES

In accordance with the Absolute Maximum Rating System (IEC 134).

SYMBOL	PARAMETER	CONDITIONS	MIN.	MAX.	UNIT
V_{RRM}	repetitive peak reverse voltage				
	1N4151		–	75	V
	1N4153		–	75	V
V_R	continuous reverse voltage		–	50	V
I_F	continuous forward current	see Fig.2; note 1			
	1N4150		–	300	mA
	1N4151		–	200	mA
	1N4153		–	200	mA
I_{FRM}	repetitive peak forward current				
	1N4150		–	600	mA
	1N4151		–	450	mA
	1N4153		–	450	mA
I_{FSM}	non-repetitive peak forward current	square wave; $T_j = 25\text{ °C}$ prior to surge; see Fig.4			
		$t = 1\ \mu\text{s}$	–	4	A
		$t = 1\ \text{ms}$	–	1	A
		$t = 1\ \text{s}$	–	0.5	A
P_{tot}	total power dissipation	$T_{amb} = 25\text{ °C}$; note 1	–	500	mW
T_{stg}	storage temperature		–65	+200	°C
T_j	junction temperature		–	200	°C

Note

1. Device mounted on an FR4 printed-circuit board; lead length 10 mm.

High-speed diodes

1N4150; 1N4151; 1N4153

ELECTRICAL CHARACTERISTICS $T_j = 25\text{ °C}$; unless otherwise specified.

SYMBOL	PARAMETER	CONDITIONS	MIN.	MAX.	UNIT
V_F	forward voltage 1N4150 1N4151 1N4153	see Fig.3			
		$I_F = 1\text{ mA}$	540	620	mV
		$I_F = 10\text{ mA}$	660	740	mV
		$I_F = 50\text{ mA}$	760	860	mV
		$I_F = 100\text{ mA}$	820	920	mV
		$I_F = 200\text{ mA}$	870	1000	mV
		$I_F = 50\text{ mA}$	–	1000	mV
		$I_F = 0.1\text{ mA}$	490	550	mV
		$I_F = 0.25\text{ mA}$	530	590	mV
		$I_F = 1\text{ mA}$	590	670	mV
		$I_F = 2\text{ mA}$	620	700	mV
		$I_F = 10\text{ mA}$	700	810	mV
$I_F = 50\text{ mA}$	740	880	mV		
I_R	reverse current 1N4150 1N4151 1N4153	$V_R = 50\text{ V}$; see Fig.5	–	0.1	μA
			–	0.05	μA
			–	0.05	μA
I_R	reverse current 1N4150 1N4151 1N4153	$V_R = 50\text{ V}$; $T_j = 150\text{ °C}$; see Fig.5	–	100	μA
			–	50	μA
			–	50	μA
C_d	diode capacitance 1N4150 1N4151 1N4153	$f = 1\text{ MHz}$; $V_R = 0$; see Fig.6	–	2.5	pF
			–	2	pF
			–	2	pF

High-speed diodes

1N4150; 1N4151; 1N4153

SYMBOL	PARAMETER	CONDITIONS	MIN.	MAX.	UNIT
t_{rr}	reverse recovery time 1N4150	when switched from $I_F = 10$ mA to $I_R = 1$ mA; $R_L = 100 \Omega$; measured at $I_R = 0.1$ mA; see Fig.7	–	6	ns
		when switched from $I_F = 10$ mA to 200 mA to $I_R = 10$ mA to 200 mA; $R_L = 100 \Omega$; measured at $I_R = 0.1 \times I_F$; see Fig.7	–	4	ns
		when switched from $I_F = 200$ mA to 400 mA to $I_R = 200$ mA to 400 mA; $R_L = 100 \Omega$; measured at $I_R = 0.1 \times I_F$; see Fig.7	–	6	ns
t_{rr}	reverse recovery time 1N4151	when switched from $I_F = 10$ mA to $I_R = 10$ mA; $R_L = 100 \Omega$; measured at $I_R = 1$ mA; see Fig.7	–	4	ns
		when switched from $I_F = 10$ mA to $I_R = 60$ mA; $R_L = 100 \Omega$; measured at $I_R = 1$ mA; see Fig.7	–	2	ns
t_{rr}	reverse recovery time 1N4153	when switched from $I_F = 10$ mA to $I_R = 10$ mA; $R_L = 100 \Omega$; measured at $I_R = 1$ mA; see Fig.7	–	4	ns
		when switched from $I_F = 10$ mA to $I_R = 60$ mA; $R_L = 100 \Omega$; measured at $I_R = 1$ mA; see Fig.7	–	2	ns
t_{fr}	forward recovery time	when switched to $I_F = 200$ mA; $t_r = 0.4$ ns; measured at $V_F = 1$ V; see Fig.8	–	10	ns

THERMAL CHARACTERISTICS

SYMBOL	PARAMETER	CONDITIONS	VALUE	UNIT
$R_{th\ j-tp}$	thermal resistance from junction to tie-point	lead length 10 mm	240	K/W
$R_{th\ j-a}$	thermal resistance from junction to ambient	lead length 10 mm; note 1	350	K/W

Note

1. Device mounted on a printed circuit-board without metallization pad.

High-speed diodes

1N4150; 1N4151; 1N4153

GRAPHICAL DATA

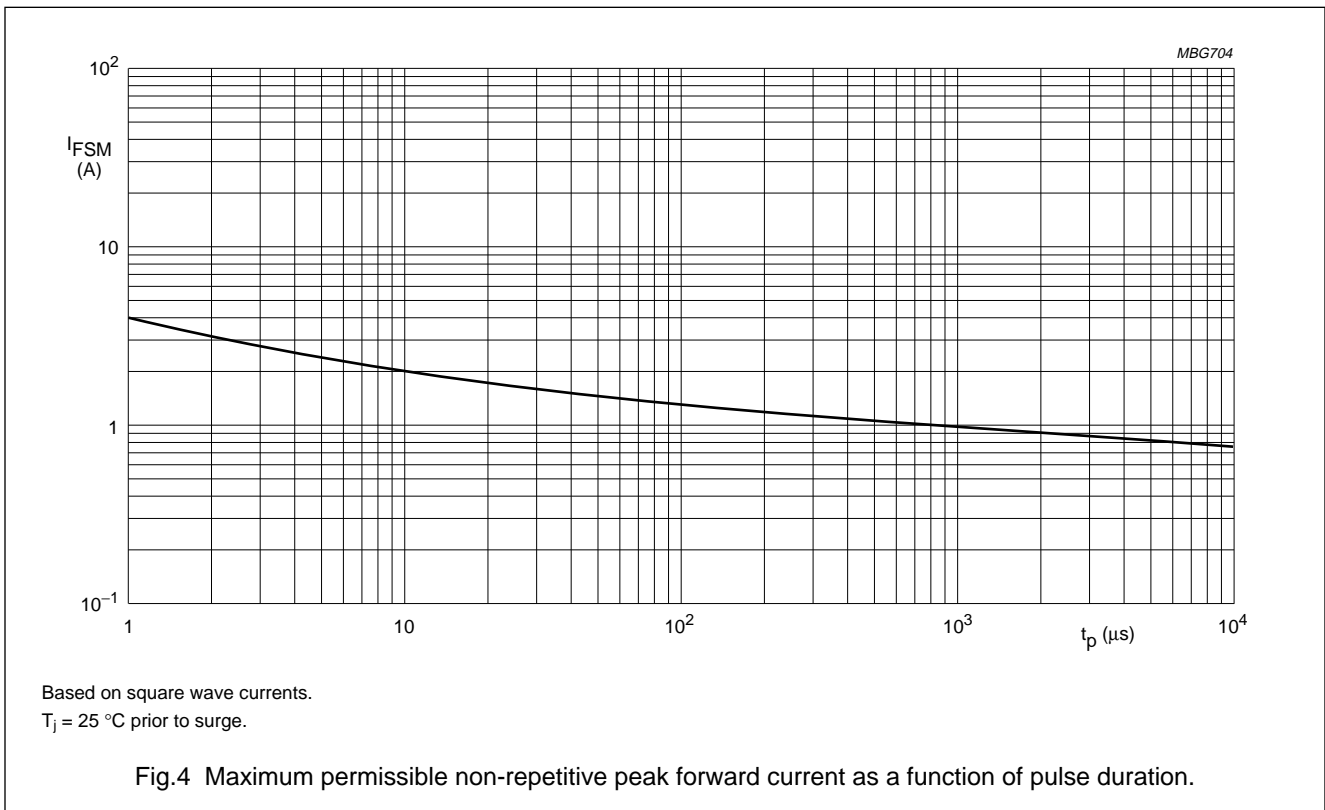
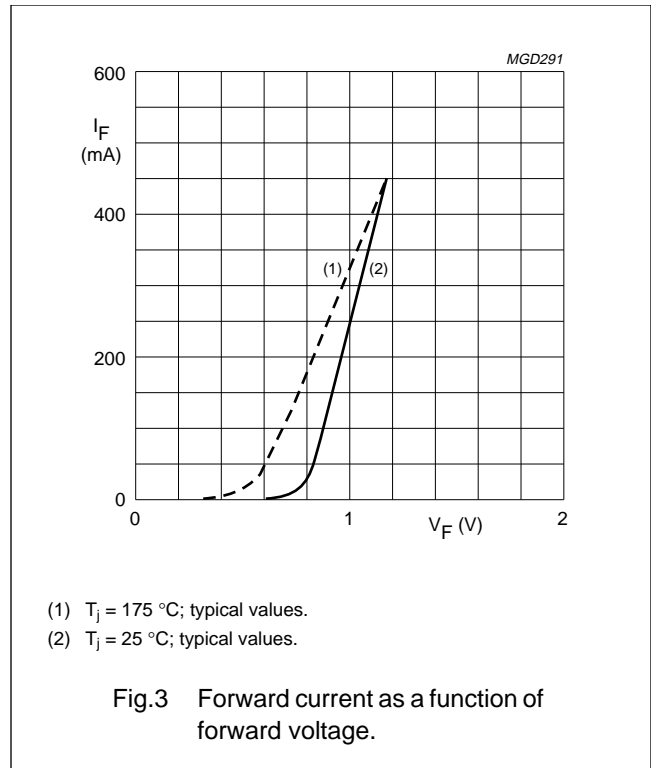
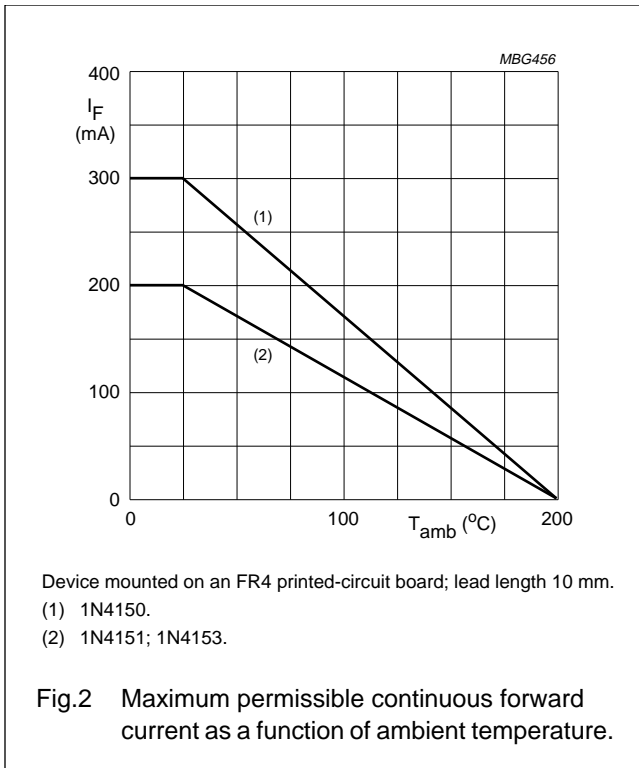

High-speed diodes

1N4150; 1N4151; 1N4153

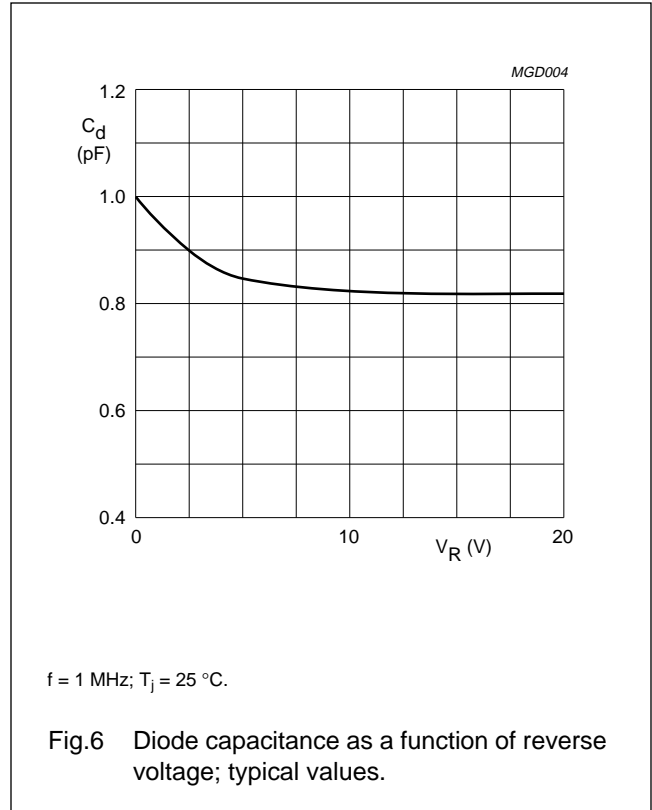
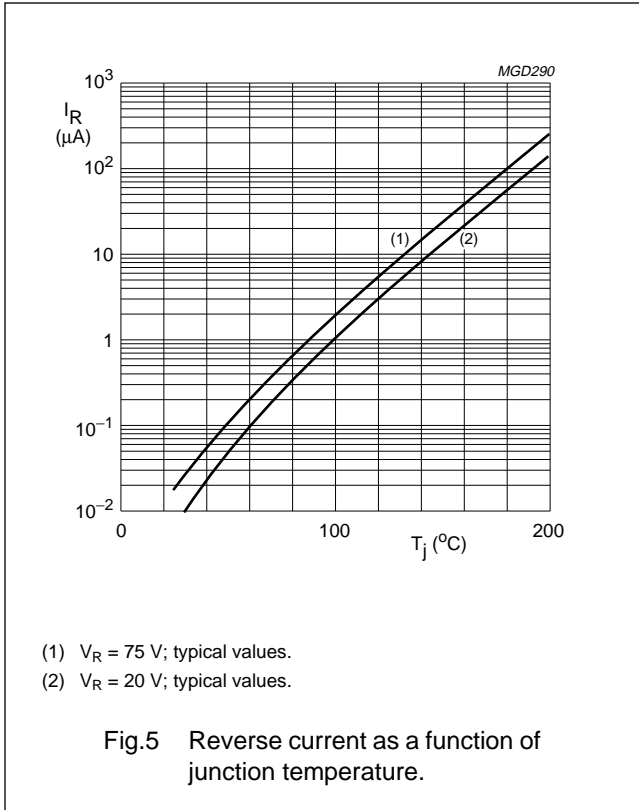

High-speed diodes

1N4150; 1N4151; 1N4153

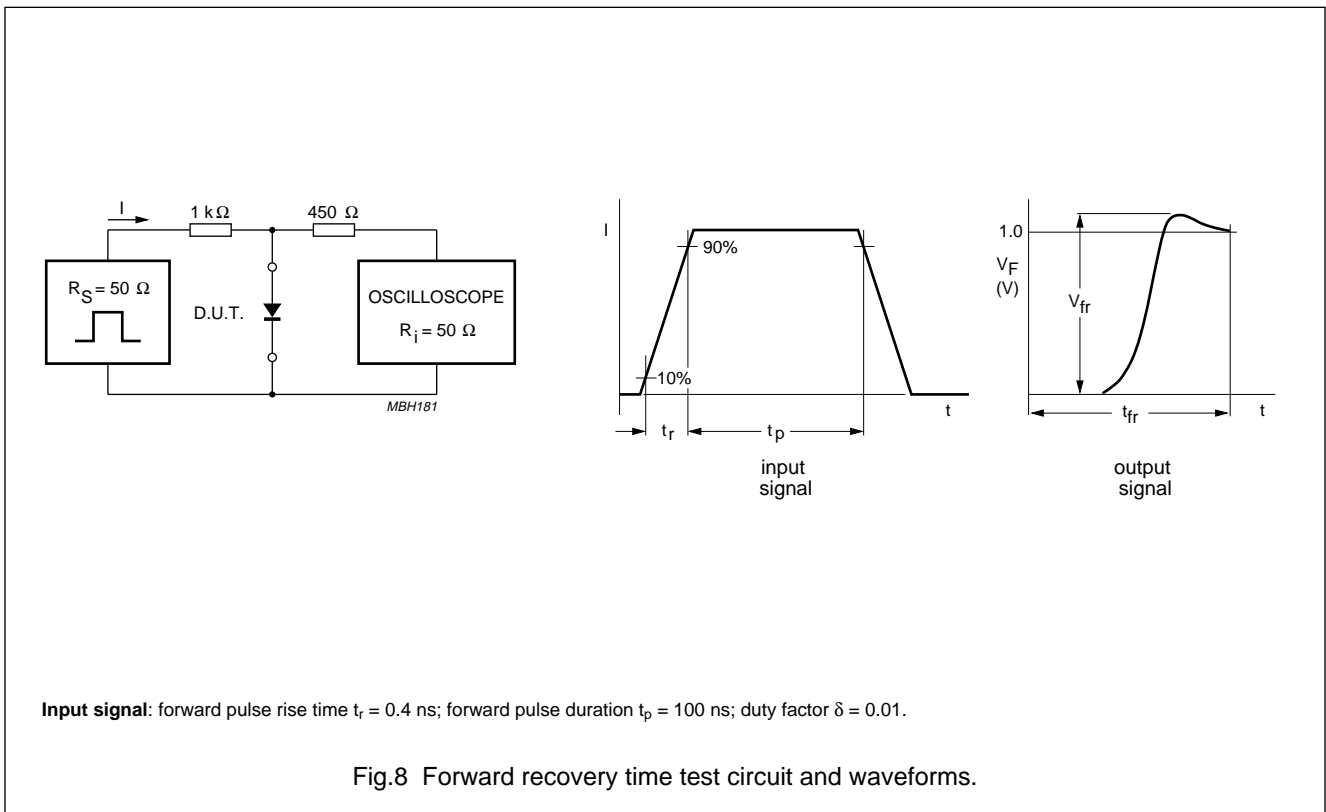
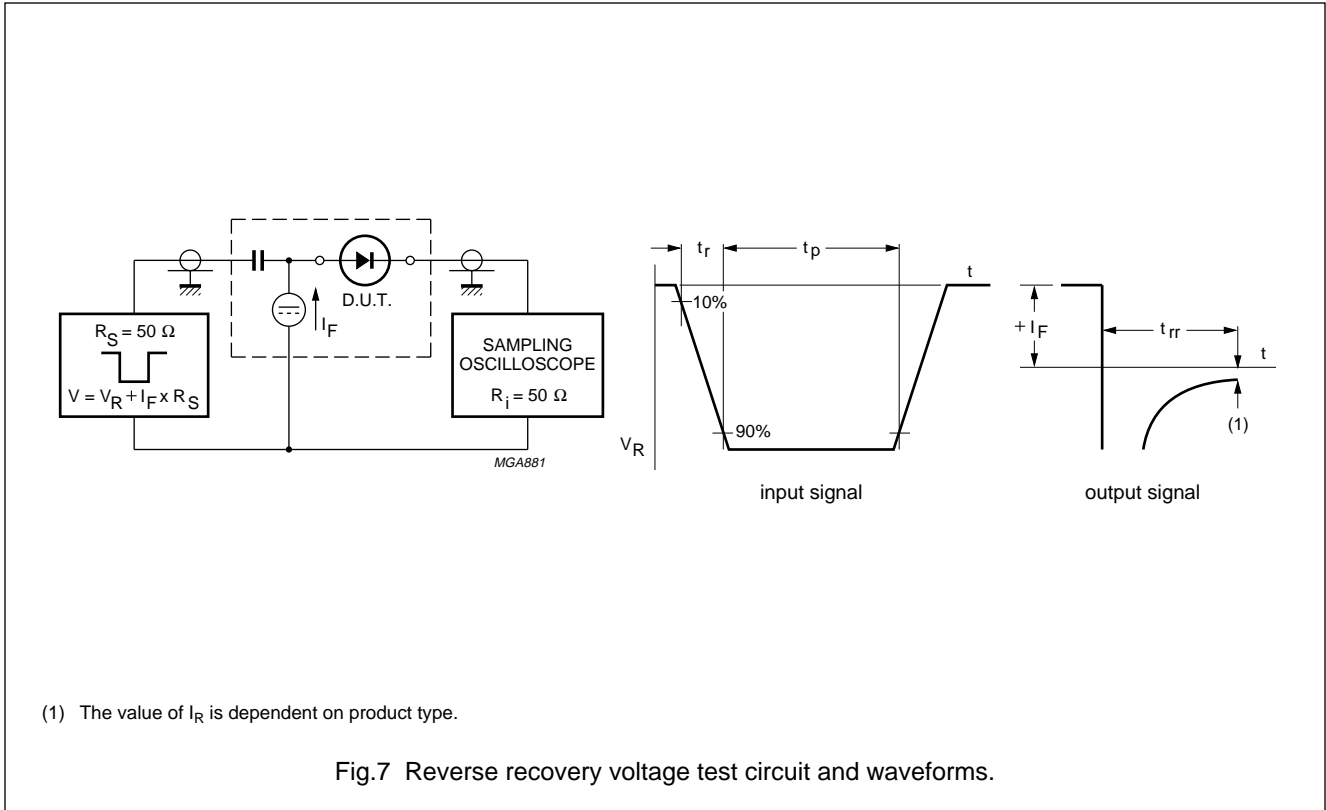

High-speed diodes

1N4150; 1N4151; 1N4153

PACKAGE OUTLINE

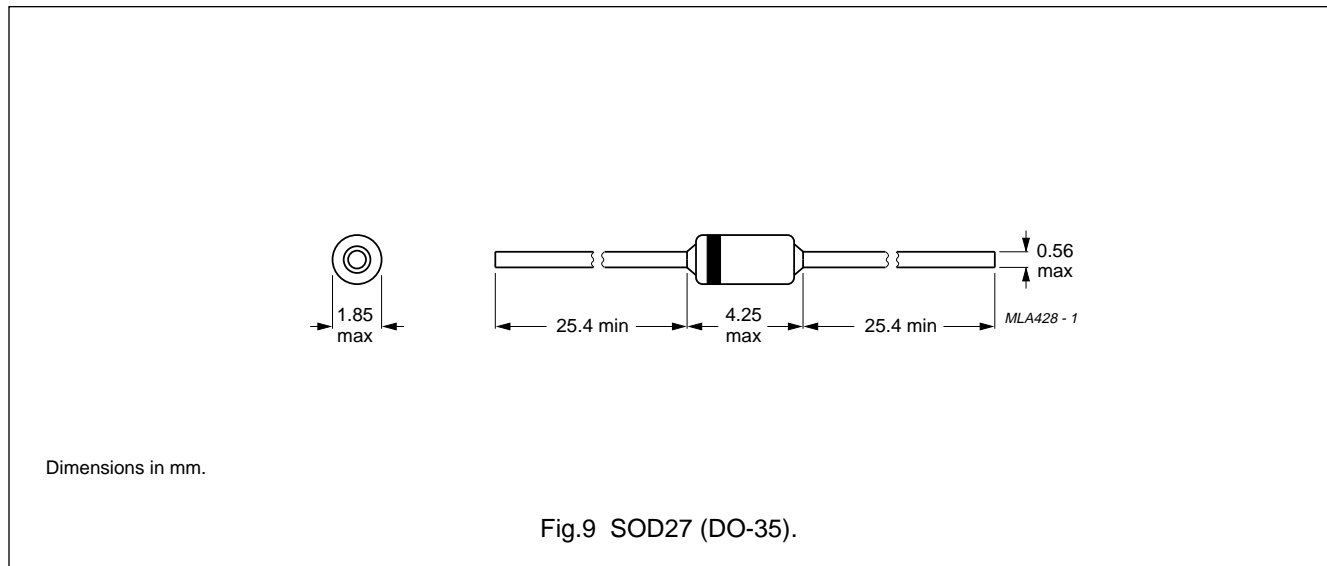

DEFINITIONS

Data Sheet Status	
Objective specification	This data sheet contains target or goal specifications for product development.
Preliminary specification	This data sheet contains preliminary data; supplementary data may be published later.
Product specification	This data sheet contains final product specifications.
Limiting values	
Limiting values given are in accordance with the Absolute Maximum Rating System (IEC 134). Stress above one or more of the limiting values may cause permanent damage to the device. These are stress ratings only and operation of the device at these or at any other conditions above those given in the Characteristics sections of the specification is not implied. Exposure to limiting values for extended periods may affect device reliability.	
Application information	
Where application information is given, it is advisory and does not form part of the specification.	

LIFE SUPPORT APPLICATIONS

These products are not designed for use in life support appliances, devices, or systems where malfunction of these products can reasonably be expected to result in personal injury. Philips customers using or selling these products for use in such applications do so at their own risk and agree to fully indemnify Philips for any damages resulting from such improper use or sale.