

***USER'S MANUAL***  
***Of***  
***VIA P4M890 Chipset***  
***&***  
***VIA VT8237R Plus Chipset***  
***M/B For LGA775 Conroe & Dual Core Ready***  
***Intel Pentium-D Processor***

***NO. G03-P4M9MP-FR111***

***Rev:3.0***

***Release date: September 2006***

**Trademark:**

\* Specifications and Information contained in this documentation are furnished for information use only, and are subject to change at any time without notice, and should not be construed as a commitment by manufacturer.

## Environmental Protection Announcement

Do not dispose this electronic device into the trash while discarding. To minimize pollution and ensure environment protection of mother earth, please recycle.



---

---

# TABLE OF CONTENT

---

---

USER'S NOTICE .....	iii
MANUAL REVISION INFORMATION .....	iii
COOLING SOLUTIONS .....	iii
<b>CHAPTER 1 INTRODUCTION OF VIA P4M890 CHIPSET MOTHERBOARD</b>	
1-1 FEATURE OF MOTHERBOARD.....	1
1-2 SPECIFICATION.....	2
1-3 PERFORMANCE LIST .....	3
1-4 LAYOUT DIAGRAM & JUMPER SETTING.....	4
<b>CHAPTER 2 HARDWARE INSTALLATION</b>	
2-1 HARDWARE INSTALLATION STEPS .....	6
2-2 CHECKING MOTHERBOARD'S JUMPER SETTING .....	6
2-3 INSTALL CPU.....	7
2-3-1 GLOSSARY .....	7
2-3-2 ABOUT INTEL PENTIUM4 LGA 775 CPU .....	8
2-3-3 LGA 775 CPU INSTALLATION GUIDE .....	9
2-4 INSTALL MEMORY .....	18
2-5 EXPANSION CARD.....	19
2-5-1 PROCEDURE FOR EXPANSION CARD INSTALLATION.....	19
2-5-2 ASSIGNING IRQ FOR EXPANSION CARD .....	19
2-5-3 PCI EXPRESS SLOT.....	20
2-6 CONNECTORS, HEADERS.....	21
2-6-1 CONNECTORS.....	21
2-6-2 HEADERS.....	25
2-7 STARTING UP YOUR COMPUTER.....	28
<b>CHAPTER 3 INTRODUCING BIOS</b>	
3-1 ENTERING SETUP.....	29
3-2 GETTING HELP .....	29
3-3 THE MAIN MENU .....	30
3-4 STANDARD CMOS FEATURES.....	31
3-5 ADVANCED BIOS FEATURES .....	32
3-6 ADVANCED CHIPSET FEATURES.....	34
3-6-1 CLOCK/DRIVE CONTROL .....	35
3-6-2 AGP&P2P BRIDGE CONTROL.....	36
3-6-3 CPU&PCI BUS CONTROL .....	36
3-7 INTEGRATED PERIPHERALS.....	37
3-7-1 VIA ONCHIP IDE DEVICE .....	37
3-7-2 VIA ONCHIP PCI DEVICE.....	38
3-7-3 SUPER I/O DEVICE.....	39
3-8 POWER MANAGEMENT SETUP .....	40
3-8-1 IRQ/EVENT ACTIVITY DETECT.....	41
3-8-1.1 IRQS ACTIVITIES .....	42
3-9 MISCELLANEOUS CONTROL.....	42
3-9-1 IRQ RESOURCES .....	43
3-10 PC HEALTH STATUS .....	44
3-11 THERMAL THROTTLING OPTION.....	45
3-12 POWER USER OVERCLOCK SETTINGS.....	45
3-13 PASSWORD SETTINGS.....	48
3-14 LOAD OPTIMIZED/FAIL-SAFE DEFAULTS.....	48
<b>CHAPTER 4 DRIVER &amp; FREE PROGRAM INSTALLATION</b>	
MAGIC INSTALL SUPPORTS WINDOWS 9X/ME/NT4.0/2000/XP .....	49
4-1 VIA 4 IN 1       INSTALL VIA SERVICE PACK 4 IN 1 DRIVER .....	50
4-2 VGA             INSTALL VIA P4M890 VGA DRIVER .....	51
4-3 SOUND          INSTALL VIA AC97 CODEC AUDIO DRIVER .....	51
4-4 LAN             INSTALL VIA LAN CONTROLLER DRIVER.....	52
4-5 PC-HEALTH       INSTALL MYGUARD HARDWARE MONITOR UTILITY.....	53
4-6 PC-CILLIN       INSTALL PC-CILLIN2006 ANTI-VIRUS PROGRAM .....	54
4-7 USB2.0          INSTALL VIA USB2.0 DEVICE DRIVER .....	55
4-8 SATA            INSTALL VIA SERIAL ATA.....	56
4-9 HOW TO DISABLE ON-BOARD SOUND .....	57
4-10 HOW TO UPDATE BIOS.....	57

---

---

## USER'S NOTICE

**COPYRIGHT OF THIS MANUAL BELONGS TO THE MANUFACTURER. NO PART OF THIS MANUAL, INCLUDING THE PRODUCTS AND SOFTWARE DESCRIBED IN IT MAY BE REPRODUCED, TRANSMITTED OR TRANSLATED INTO ANY LANGUAGE IN ANY FORM OR BY ANY MEANS WITHOUT WRITTEN PERMISSION OF THE MANUFACTURER.**

**THIS MANUAL CONTAINS ALL INFORMATION REQUIRED TO USE VIA P4M890 CHIPSET MOTHER-BOARD AND WE DO ASSURE THIS MANUAL MEETS USER'S REQUIREMENT BUT WILL CHANGE, CORRECT ANY TIME WITHOUT NOTICE. MANUFACTURER PROVIDES THIS MANUAL "AS IS" WITHOUT WARRANTY OF ANY KIND, AND WILL NOT BE LIABLE FOR ANY INDIRECT, SPECIAL, INCIDENTAL OR CONSEQUENTIAL DAMAGES (INCLUDING DAMAGES FOR LOSS OF PROFIT, LOSS OF BUSINESS, LOSS OF USE OF DATA, INTERRUPTION OF BUSINESS AND THE LIKE).**

**PRODUCTS AND CORPORATE NAMES APPEARING IN THIS MANUAL MAY OR MAY NOT BE REGISTERED TRADEMARKS OR COPYRIGHTS OF THEIR RESPECTIVE COMPANIES, AND THEY ARE USED ONLY FOR IDENTIFICATION OR EXPLANATION AND TO THE OWNER'S BENEFIT, WITHOUT INTENT TO INFRINGE.**

## Manual Revision Information

Reversion	Revision History	Date
2.0	Third Edition	September 2006

## Item Checklist

- VIA P4M890 Chipset motherboard
- Cable for IDE
- CD for motherboard utilities
- Cable for Serial ATA IDE Port
- VIA P4M890 Chipset motherboard User's Manual

## Intel Pentium 4 Processor Family

### Cooling Solutions

As processor technology pushes to faster speeds and higher performance, thermal management becomes increasingly crucial while building computer systems. Maintaining the proper thermal environment is the key to reliable, long-term system operation. The overall goal in providing the proper thermal environment is keeping the processor below its specified maximum case temperature. Heat sinks induce improved processor heat dissipation through increased surface area and concentrated airflow from attached fans. In addition, interface materials allow effective transfers of heat from the processor to the heat sink. For optimum heat transfer, Intel recommends the use of thermal grease and mounting clips to attach the heat sink to the processor.

When selecting a thermal solution for your system, please refer to the website below for collection of heat sinks evaluated and recommended by Intel for use with Intel processors. Note, those heat sinks are recommended for maintaining the specified Maximum T case requirement. In addition, this collection is not intended to be a comprehensive listing of all heat sinks that support Intel processors.

For vendor list of certified heat sinks and cooling fans, please visit :

<http://developer.intel.com/design/Pentium4/components/index>

---

---

# Chapter 1

## Introduction of VIA P4M890 Chipset Motherboards

### 1-1 Feature of motherboard

The VIA P4M890 chipset motherboard series are designed for the innovative 65nm and 90nm Dual-Core Intel® Pentium® D Processor 8 and 9 Series, Intel® Pentium® D Processor, and Intel® Core 2 Duo® (Code Name: Conroe) Processor with Intel® Hyper-Threading Technology. With the cost-effective VIA P4M890 chipset that delivers a high performance and professional desktop platform solution.

The VIA P4M890 chipset motherboard series implement VIA P4M890 chipset which supports 400MHz/ 533MHz /800MHz/1066MHz system bus of data transfer rate and Hyper Threading technology. The VIA P4M890 chipset motherboard series provide 133MHz / 100MHz memory clock frequency for DDR2 533/400 system RAM Modules. The motherboard series are embedded with VIA VT8237R Plus South Bridge offers **ULTRA ATA 133** and **Serial ATA with RAID 0, 1, JBOD** functions to provide speedier HDD throughout that boosts overall system performance. The VIA P4M890 Chipset motherboard series implement the VIA VT6103L LAN PHY chip Support Fast Ethernet LAN function provide 10/100 Mb/s data transfer rate.

The motherboard series also have an integrated 6-channel AC'97 CODEC on board which is fully compatible with Sound Blaster Pro® that gives you the best sound quality and compatibility.

The VIA P4M890 Chipset motherboard series are integrated with S3 Graphics UniChrome Pro Integrated Graphics Processor with high performance & high quality 3D accelerator that supports Ultra-AGP II with 2GB/s bandwidth; the built-in MPEG-2/1 Video Decoder and Video Accelerator fully supports VCD DVD HDTV decoding and playback, it also supports graphic and video overlay function. Built-in programmable 24-bit true-color RAMDAC up to 250MHz pixel clock. Programmable frame buffer size which is from 16MB and up to 64MB for those who asking for even greater graphic performance. The VIA P4M890 chipset motherboard series provide one PCI-Express x16 graphics slot of 4Gbyte/sec data transfer rate at each relative direction which gets 3.5 times of bandwidth more than AGP8X and it's up to a peak concurrent bandwidth of 8Gbyte/sec at full speed to guarantee the fully operational GPU graphics power; one PCI Express x1 I/O slot offers 512Mbyte/sec concurrently which is 3.5 times bandwidth more than PCI at 133Mbyte/sec.

With USB controller as well as capability of expanding to 8x USB2.0 function ports delivering 480Mb/s bandwidth and rich connectivity, the motherboards meet future USB demand also have built-in hardware monitor function to monitor and protect your computer.

The motherboards provide high performance & meet future specification demand of the next generation operation system. It is a wise choice for your none stop business computing.

## 1-2 Specification

Spec	Description
<b>Design</b>	* Micro ATX form factor 4 layers PCB size: 24.5x21.0cm
<b>Chipset</b>	* VIA P4M890 North Bridge Chipset * VIA VT8237R Plus South Bridge Chipset
<b>CPU Socket (LGA 775 Socket)</b>	* Support Intel Pentium 4, Celeron D, Pentium D, and Core 2 Duo 775-Land LGA Package utilizes Flip-Chip Land Grid Array (FCLGA4) package processor * Support FSB Frequency 533MHz / 800 / 1066MHz
<b>Memory Socket</b>	* 240-pin DDRII Module socket x 2 * Support 2pcs DDRII 533 / 400 system memory modules which are expandable to 2.0GB
<b>Expansion Slot</b>	* PCI-Express x16 slot 1pcs deliver up to 8GB/s concurrent bandwidth * PCI-Express x1 slot 1pcs delivers up to 512MB/s concurrent bandwidth * 32-bit PCI slot x 2pcs
<b>Integrate IDE and Serial ATA RAID</b>	* Two PCI IDE controllers support PCI Bus Mastering, ATA PIO/DMA and the ULTRA DMA 33/66/100/133 functions that deliver the data transfer rate up to 133 MB/s; Two Serial ATA ports provide 150 MB/sec data transfer rate for two Serial ATA Devices and offer RAID 0, 1, JBOD functions
<b>VGA</b>	* Integrated S3 Graphics UniChrome Pro Integrated Graphics Processor * Support Ultra-AGP II with 2GB/s bandwidth * Built-in programmable 24-bit true-color RAMDAC up to 250MHz pixel clock * Programmable frame buffer size from 16MB and up to 64MB.
<b>Optional LAN</b>	* Optional Integrated VIA 6103L PCI-10 /100 LAN PHY * Supports Fast Ethernet LAN function provide 10Mb / 100Mb / s data transfer rate
<b>Audio</b>	* VIA VT1616B AC'97 Digital Audio controller integrated * 6-channel AC'97 Audio CODEC onboard * Audio driver and utility included
<b>BIOS</b>	* Award 4MB Flash ROM
<b>Multi I/O</b>	* PS/2 keyboard and PS/2 mouse connectors * Floppy disk drive connector x1 * Parallel port x1 * Serial port x1 * VGA port x1 * USB2.0 port x 4 and headers x 4 (connecting cable option) * Audio connector (Line-in, Line-out, MIC)

---



---

## 1-3 Performance List

The following performance data list is the testing result of some popular benchmark testing programs. These data are just referred by users, and there is no responsibility for different testing data values gotten by users (the different Hardware & Software configuration will result in different benchmark testing results.)

### Performance Test Report

**CPU:** Intel Pentium D 830 3GHz (FSB 1066) Hyper-Threading Support  
**DRAM:** KINGMAX Klcc 512M DDR2-533 X 2 PCS Total 1Gbyte Memory  
**VGA Expansion Card:** ON BOARD VGA Share 64M(1024X768X32BIT Color)  
**Hard Disk Driver:** IBM IC35L040AVVN07-0 (ATA-100 7200RPM)  
**BIOS:** Award Optimal default  
**OS:** Windows XP Professional (SERVICE PACK 1)

	<b>The Motherboard</b>
3D Mark 2001SE	2332
3D Mark 2003	143
3D Winbench 2000 (32/32bit)	N / A
AQUAMARK3(GFX/CPU)	5115(531 / 6949)
PCMark2004	
System/CPU/Memory/Graph/HDD	4605 / 5882 / 3912 / 771 / 4495
Content Creation Winstone 2002	N / A
Content Creation Winstone 2003	N / A
Business Winstone 2002	N / A
Content Creation Winstone 2004	29.2
Business Winstone 2004	22.3
Winbench 99 V1.2:	
Business/Hi-end Disk Winmark99	6020 / 20600
Business/Hi-end Graphic Winmark	N / A
SIS Mark 2004: SISMark 2004 Rating (Internet Content Creation / Office Productivity)	
3D Creation/2D Creation/Web publication	N / A
Communication/Document Creation/Data Analysis	N / A
SISOFT Sandra 2004:	
Dhrystone ALU MIPS	4284/7379
Whetstone FPU MFLOPS	3477/3476
RAM Int Buffered iSSE2 MB/S	33574/38708
RAM Float Buffered iSSE2 MB/S	19.16/16.68
Floating- Point SSE2 IT/S	N/A
QUAKE3 DEMO1/DEMO2 FPS	46.891s
Return to Castle Wolfenstein FPS	200/266/3000
Super Pi (1M) Second	4284/7379
CPUZ System/ memory / CPUMHZ	200.04 / 3000.54

# 1-4 Layout Diagram & Jumper Setting

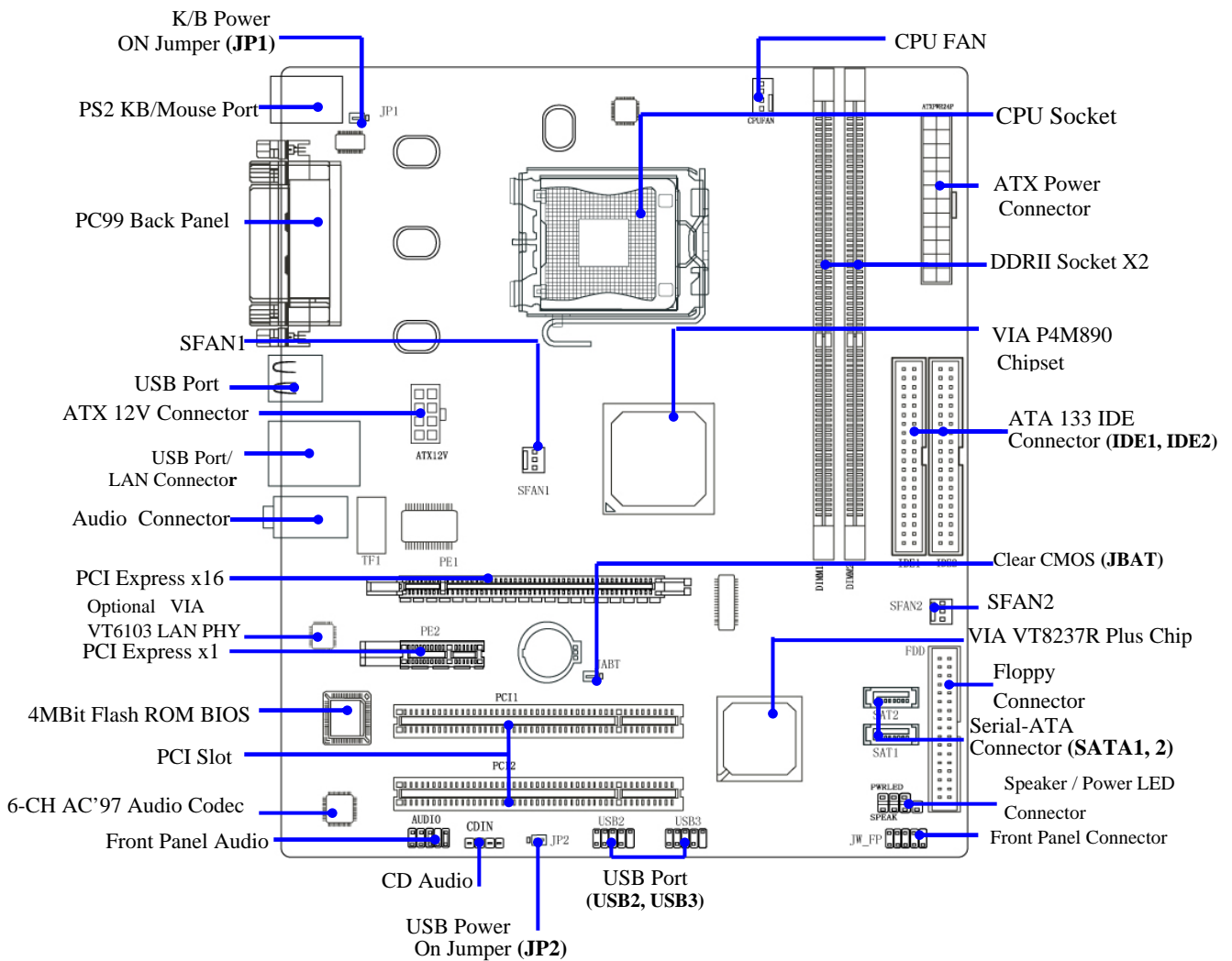
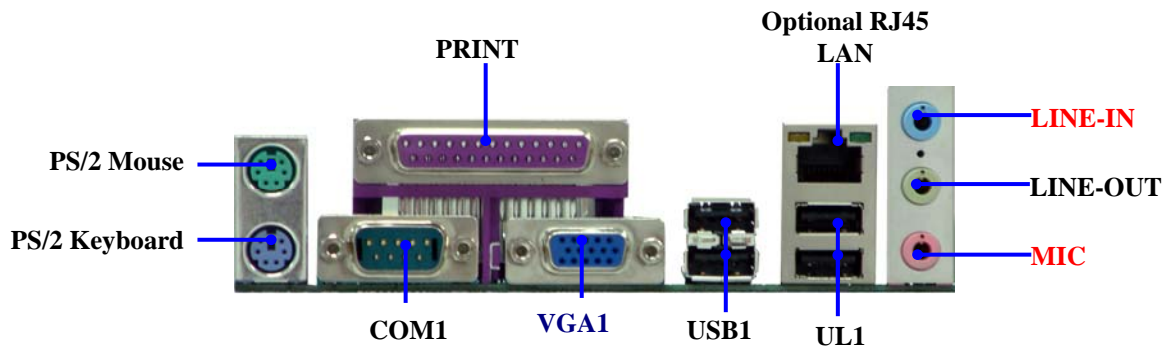

*The motherboards feature Two Serial ATA HDD with RAID0,1,and JBOD functions. DDR2533/ DDR2400 DDR Modules,1066MHZ system bus, PCI Express x16 graphics port and PCI Express x1 I/O ports and Hi-Speed USB 2.0 connectivity .*

---

---

## *Jumpers*

<b>Jumper</b>	<b>Name</b>	<b>Description</b>	<b>Page</b>
JBAT	CMOS RAM Clear	3-pin Block	P.6
JP1	Keyboard Power On Enable/Disabled	3-pin Block	P.7
JP2	USB Power On Enable/Disabled	3-pin Block	P.7

## *Connectors*

<b>Connector</b>	<b>Name</b>	<b>Description</b>	<b>Page</b>
ATXPWR	Power Connector	24-pin Block	P.21
ATX12V	ATX 12V Power Connector	8-pin Block	P.22
PS2KBMS	PS/2 Mouse & PS/2 Keyboard Connector	6-pin Female	P.22
USB1	USB Port Connector	4-pin Connector	P.22
UL1	LAN Port Connector	RJ-45 Connector	P.22
PARALLEL	Parallel Port Connector	25-pin Female	P.22
AUDIO	Audio Connector	3 phone jack Connector	P.22
COM1	Serial Port COM1 Connector	9-pin Connector	P.22
VGA1	VGA Connector	15-pin Female	P.23
FDD	Floppy Driver Connector	34-pin Block	P.23
SATA1/2	Serial ATA IDE Connector	7-pin Connector	P.24
IDE1/IDE2	Primary/Secondary IDE Connector	40-pin Block	P.23

## *Headers*

<b>Header</b>	<b>Name</b>	<b>Description</b>	<b>Page</b>
AUDIO	MIC header	9-pin Block	P.25
USB2, USB3	USB Port Headers	9-pin Block	P.25
HD LED	IDE activity LED	2-pin Block	P.25
RESET	Reset switch lead	2-pin Block	P.25
SPEAK	PC Speaker connector	4-pin Block	P.25
PWR LED	Power LED	2-pin Block	P.26
PWR BTN	Power switch	2-pin Block	P.26
SFAN1, SFAN2 ,CPUFAN	FAN Headers	3-pin Block	P.26
IR	IR infrared module Headers	5-pin Block	P.27
CD_IN	CD Audio-In Headers	4-pin Block	P.27

## *Expansion Sockets*

<b>Socket/Slot</b>	<b>Name</b>	<b>Description</b>	<b>Page</b>
LGA 775 Socket	CPU Socket	LGA 775 CPU Socket	P.8
DIMM1, DIMM2	DDR2 Module Socket	240-pin DDR2 Module Socket	P.18
PCI1, PCI2	PCI Slot	32-bit PCI Local Bus Expansion slots	P.20
PE2	PCI-Express x1 Slot	PCI-Express x1 Expansion Slot	P.20
PE1	PCI-Express x16 Slot	PCI-E x 16 Expansion Slot	P.20

---

---

# Chapter 2

## Hardware installation

### 2-1 Hardware installation Steps

Before using your computer, you had better complete the following steps:

1. Check motherboard jumper setting
2. Install CPU and Fan
3. Install System Memory (DIMM)
4. Install Expansion cards
5. Connect IDE and Floppy cables, Front Panel /Back Panel cable
6. Connect ATX Power cable
7. Power-On and Load Standard Default
8. Reboot
9. Install Operating System
10. Install Driver and Utility

### 2-2 Checking Motherboard's Jumper Setting

#### (1) CMOS RAM Clear (3-pin) : JBAT

A battery must be used to retain the motherboard configuration in CMOS RAM short 1-2 pins of JBAT to store the CMOS data.

To clear the CMOS, follow the procedure below:

1. Turn off the system and unplug the AC power
2. Remove ATX power cable from ATX power connector
3. Locate JBAT and short pins 2-3 for a few seconds
4. Return JBAT to its normal setting by shorting pins 1-2
5. Connect ATX power cable back to ATX power connector

**Note: When should clear CMOS**

1. *Troubleshooting*
2. *Forget password*
3. *After over clocking system boot fail*

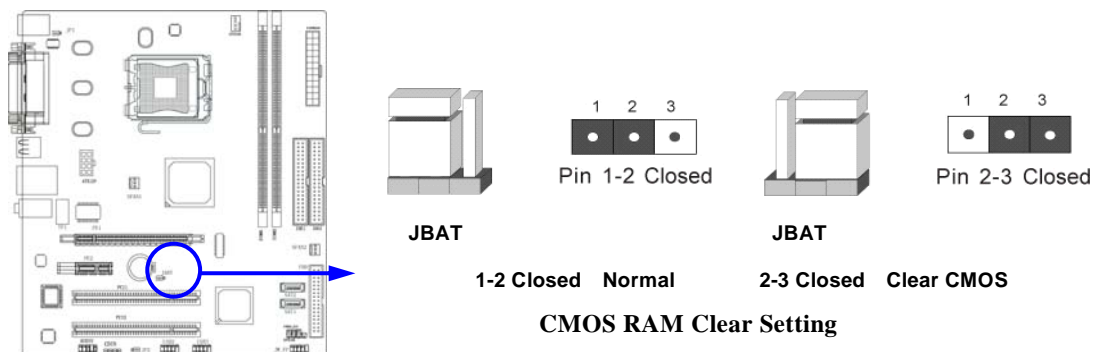

---

---

## (2) Keyboard function Enabled/Disabled: JP1

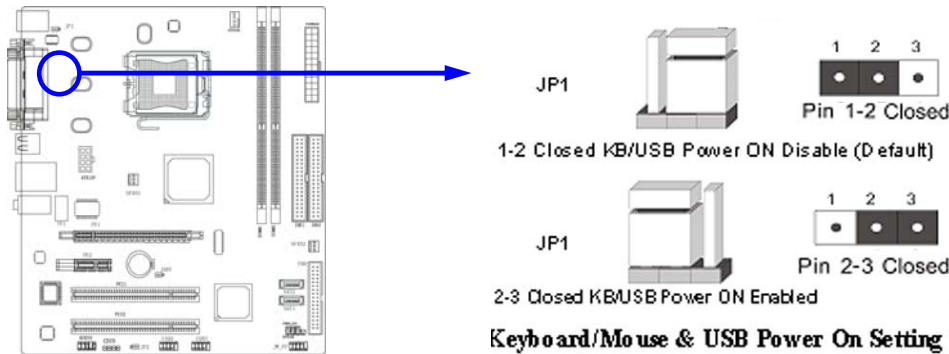

## (3) USB Power On function Enabled/Disabled: JP2

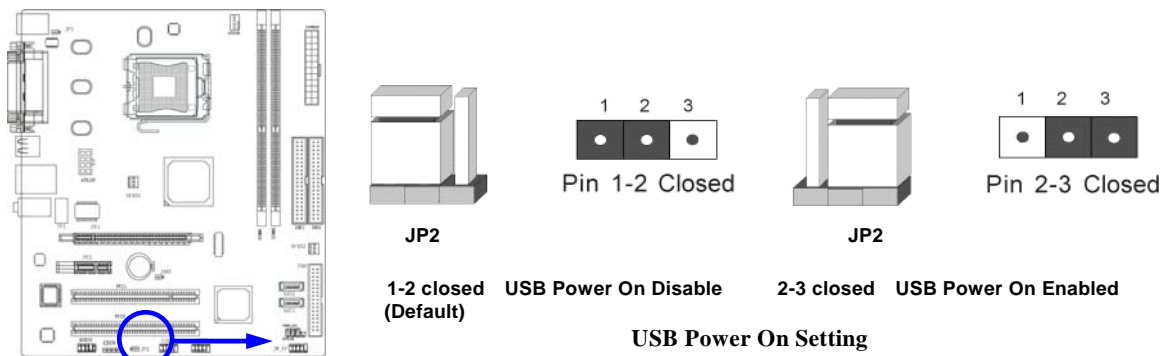

## 2-3 Install CPU

### 2-3-1 Glossary

**Chipset (or core logic)** - two or more integrated circuits which control the interfaces between the system processor, RAM, I/O devices, and adapter cards.

**Processor slot/socket** - the slot or socket used to mount the system processor on the motherboard.

**Slot** (AGP, PCI, ISA, RAM) - the slots used to mount adapter cards and system RAM.

**AGP - Accelerated Graphics Port** - a high speed interface for video cards; runs at 1X (66MHz), 2X (133MHz), or 4X (266MHz), or 8X (533MHz)

**PCI - Peripheral Component Interconnect** - a high speed interface for video cards, sound cards, network interface cards, and modems; runs at 33MHz.

**ISA - Industry Standard Architecture** - a relatively low speed interface primarily used for sound cards and modems; runs at approx. 8MHz.

**Serial Port** - a low speed interface typically used for mouse and external modems.

**Parallel Port** - a low speed interface typically used for printers.

**PS/2** - a low speed interface used for mouse and keyboards.

---

---

**USB - Universal Serial Bus** - a medium speed interface typically used for mouse, keyboards, scanners, and some digital cameras.

**Sound** (interface) - the interface between the sound card or integrated sound connectors and speakers, MIC, game controllers, and MIDI sound devices.

**LAN** (interface) - **Local Area Network** - the interface to your local area network.

**BIOS (Basic Input/Output System)** - the program logic used to boot up a computer and establish the relationship between the various components.

**Driver** - software, which defines the characteristics of a device for use by another device or other software.

**Processor** - the "central processing unit" (CPU); the principal integrated circuit used for doing the "computing" in "personal computer"

**Front Side Bus Frequency** - the working frequency of the motherboard, which is generated by the clock generator for CPU, DRAM and PCI BUS.

**CPU L2 Cache** - the flash memory inside the CPU, normal it depend on CPU type.

## 2-3-2 About Intel Pentium 4 LGA775 CPU

This motherboard provides a 775-pin surface mount, LGA775 Land Grid Array socket, referred to as the LGA775 socket supports Intel Pentium 4 processor in the 775 Pin package utilizes Flip-Chip Land Grid Array (FC-LGA4) package technology.

The CPU that comes with the motherboard should have a cooling FAN attached to prevent overheating. If this is not the case, then purchase a correct cooling FAN before you turn on your system.

**WARNING!** Be sure that there is sufficient air circulation across the processor's heatsink and CPU cooling FAN is working correctly, otherwise it may cause the processor and motherboard overheat and damage, you may install an auxiliary cooling FAN, if necessary.

To install a CPU, first turn off your system and remove its cover. Locate the LGA775 socket and open it by first pulling the level sideways away from the socket then upward to a 90-degree angle. Insert the CPU with the correct orientation as shown below. The notched corner should point toward the end of the level. Because the CPU has a corner pin for two of the four corners, the CPU will only fit in the orientation as shown.

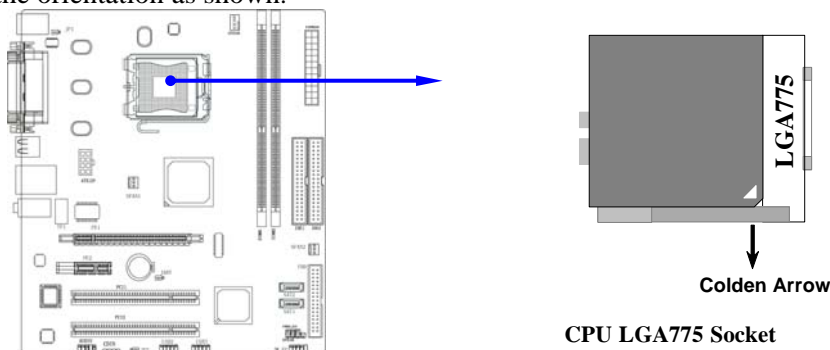

When you put the CPU into the LGA775 socket. No force require to insert of the CPU, then press the level to Locate position slightly without any extra force.

---

---

## 2-3-3 LGA 775 CPU Installation Guide

### Socket Preparation

#### 1. Opening the socket:

**Note:** Apply pressure to the corner with right hand thumb while opening/closing the load lever, otherwise lever can bounce back like a “mouse trap” and WILL cause bent contacts (when loaded)

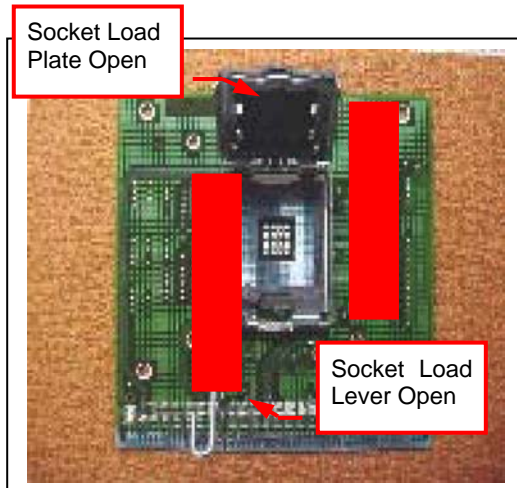

- i. Disengage Load Lever by **depressing down** and **out** on the hook to clear retention tab
- ii. Rotate Load Lever to fully open position at approximately 135degrees
- iii. Rotate Load Plate to fully open position at approximately 100degrees

#### 2. Remove PnP Cap (Pick & Place Cap)

- i. With left hand index finger and thumb to support the load plate edge, engage PnP cap with right hand thumb and peel the cap from LGA775 Socket while pressing on center of PnP cap to assist in removal.
- ii. Set PnP cap aside. Always put PnP cap back on if the processor is removed from the socket.
- iii. Visually inspect PnP cap for damage. If damage observed, replace the PnP cap.

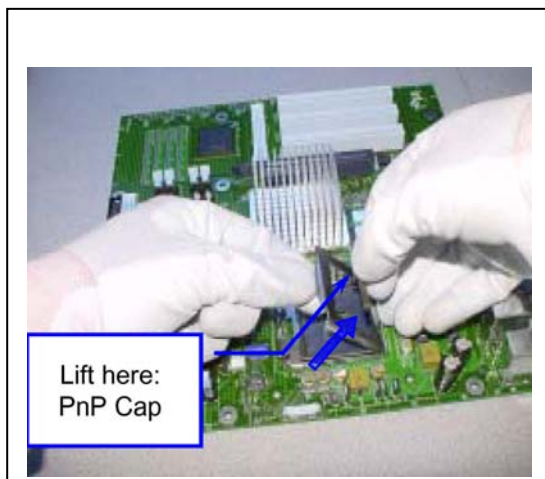

**Note:** After PnP cap removal, make sure socket load plate and contacts are free of foreign material; Refer to Overview Module for FM cleaning.

**Note:** Optionally, remove PnP cap after CPU insertion. This will compromise the ability to visually inspect socket.

---

---

### 3. Visually inspect for bent contacts (Recommend at least 1st pass visual inspection)

**NOTE:** Refer to the Handling and Inspection Module for 1st and 2nd pass inspection details.

**NOTE:** Glove images are for illustrative purposes only. Please consult local safety guidelines for specific requirements

**NOTE:** Recommend not to hold the load plate as a lever, instead hold at tab with left hand, removing the PnP cap with right hand

## 775-land LGA Package Insertion

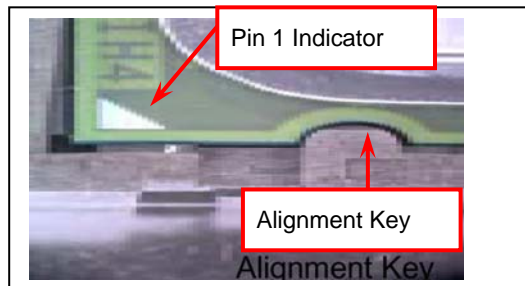

1. Lift processor package from shipping media by grasping the substrate edges ONLY.  
**Note:** Orient processor package such that the Pin 1 triangle mark is on bottom left and both key notches are on left side
2. Land Side Cover Handling: Remove land side cover with the opposite hand by depressing larger retention tab and peeling the cover away
3. Set and reserve the land side cover aside.  
**Note:** Always keep the land side cover on the processor when not in the socket.
4. Visually inspect the package gold pads: Scan the processor package gold pad array for presence of foreign material. Refer to Overview Module for FM cleaning recommendations
5. Orient the package with IHS up. Locate Pin 1 and the two orientation key notches
6. Carefully place the package into the socket body using a purely vertical motion

**CAUTION:** Using Vacuum Pen for installation is *not* recommended

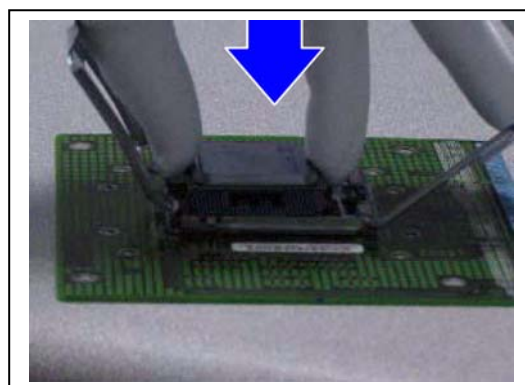

7. Verify that package is within the socket body and properly mated to the orient keys
8. Close the socket by
  - i. Rotating the Load Plate onto the package HIS
  - ii. While pressing down lightly on Load Plate, engage the Load Lever.
  - iii. Securing Load Lever with Load Plate tab under retention tab of Load Lever



## 775-Land Package Removal

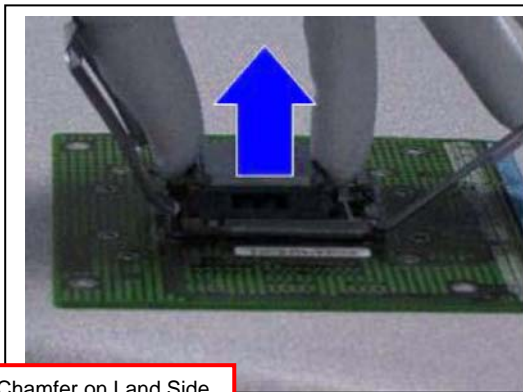

Chamfer on Land Side Cover (align this with pin 1 mark on 775-land LGA package)



Large Retention Tabs (pointing towards user)

onto

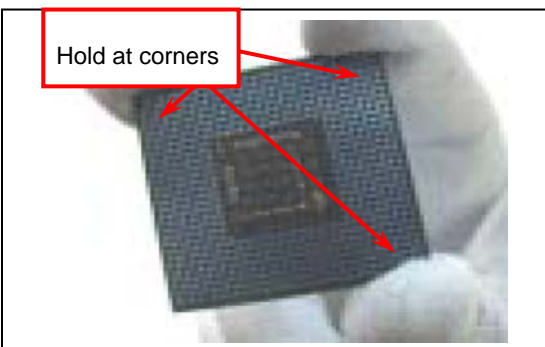

Hold at corners

1. Open the Load Plate/Lever with both hands:
  - With left hand index finger and thumb to support the load plate edge, engage PnP cap with right hand thumb and peel the cap from LGA775 Socket while pressing on center of PnP cap to assist in removal.
2. Pick up 775-land LGA package:
  - By Vacuum Pen: Place a minimum 9-mm cup at approximately the center of IHS.
  - Recommend not to place Vacuum Pen on IHS edge. Risk of dropping and causing bent contact.
  - Recommend not to use Vacuum Pen for inserting CPU By Hand: Index finger to hold load plate hinge side and thumb to hold load lever side
3. Lift the package straight up and away.
4. Assemble processors land side cover immediately to prevent contamination.
  - i. While holding the processor by the 3 corners, the other hand lift land side cover from work surface by grasping at the large retention tabs. Ensure retention tabs and package are pointing each other.
  - ii. Orientate so that land side cover chamfer is matching with package Pin 1 location.
  - iii. Hook the first large retention tab on the package substrate. Then press the opposite tab onto the substrate.
  - iv. Place processor with land side cover installed onto proper shipping media or other ESD approved work surface

---

---

## 5. Visually inspect socket contact array

### 1. First Pass Inspection

- i. Scan socket contact array at varying angles noting the presence of any foreign material
- ii. If foreign material can't be blown off by compressed air, or mechanical damage (Mode1 or 4) observed, reject the motherboard for further evaluation or socket replacement.

### 2. Second Pass Inspection

- i. Repeat 2 more times to sight down the rows and columns from each of the 4 sides of the socket to ensure all contacts within the array are inspected
- ii. Inspect for Mode2, Mode3, and Mode5 failures

**Note:** Refer to the Test Module for detail visual inspections

## 6. Assemble LGA775 socket PnP cap

- i. Secure/Hook the back side of PnP cap.
- ii. Snap down the front side to fully secure

## 7. Close the Socket

## Intel Reference Thermal Solution Assembly

**NOTE:** Depending on the configuration, Thermal Solution Integration procedure could perform with M/B alone or with M/B in the Chassis.



0.150-inch backside clearance for fastener installation

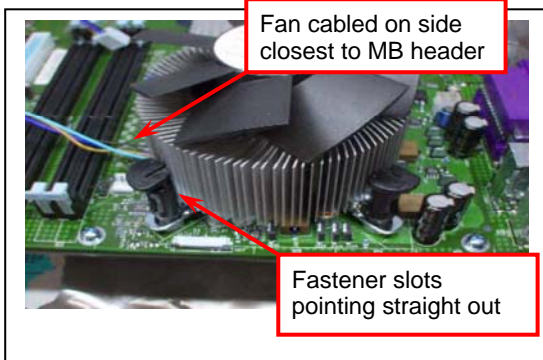
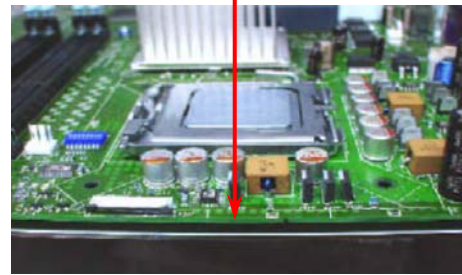

Fan cabled on side closest to MB header

Fastener slots pointing straight out

1. Place motherboard on support structure providing minimum 0.150-inch backside clearance
2. Apply 300 mg of Thermal Interface Material (Shin-Etsu G751) onto center of IHS

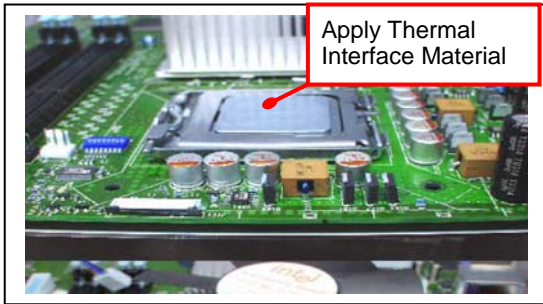

**NOTE:** Thermal Solutions that come with Intel® boxed processor use pre-applied thermal interface material and not grease.

3. Remove Heat Sink (HS) from packaging media
4. Place HS onto the LGA775 Socket
  - Ensure fan cables are oriented on side closest to fan header
  - Align Fasteners with MB through-holes

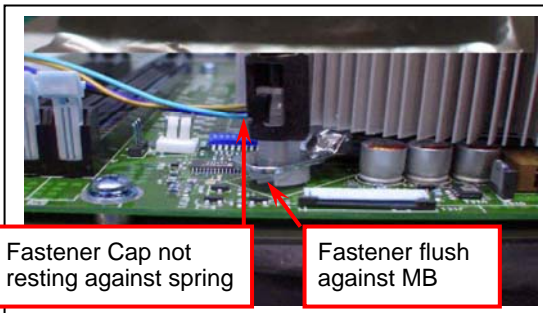

5. Inspection
  - Ensure cables are not trapped or interfere fastener operation
  - Ensure fastener slots are pointing straight out from heatsink

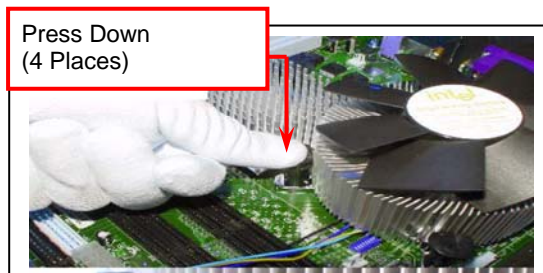

6. Actuate fasteners
  - While holding HS to prevent tilting, press down on fastener caps with thumb to install and lock
 Repeat with remaining fasteners

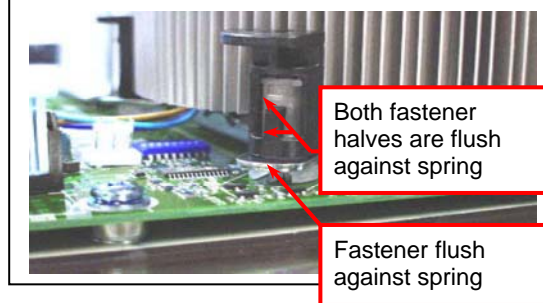

7. Inspection
  - Verify the fasteners are properly seated
  - Ensure both fastener cap and base are flush with spring and motherboard
8. Connect fan header with Board header



9. Secure excess cable with tie-wrap to ensure cable does not interfere with fan operation or contact other components.

---

---

## Intel Reference Thermal Solution Disassembly

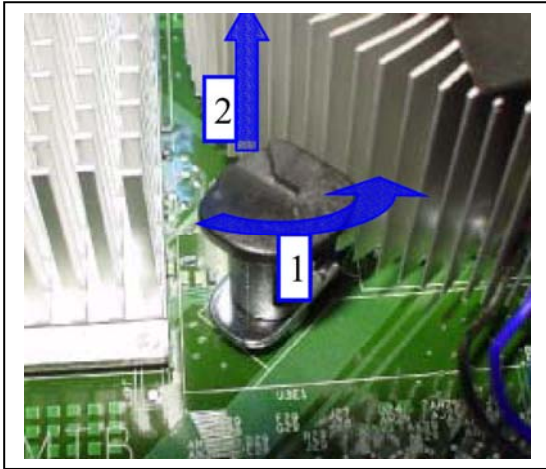

1. Rotate fastener cap. turn to un-lock
  2. Pull up fastener cap to un-seat
1. Disconnect fan cable from motherboard header
  2. Turn fastener caps (4) counter-clock wise 90degrees to the un-locked position
    - A flat-bladed screwdriver may be used if required
  3. Pull up on fastener caps to unseat
  4. Manually remove HS with gentle twist motion.
  5. To re-assemble the HS, reset the fastener caps to their original position with the slot perpendicular to the HS. Then, follow the assembly instructions.

**Note:** Thermal grease should be reapplied

## TIM and Grease Removal from CPU

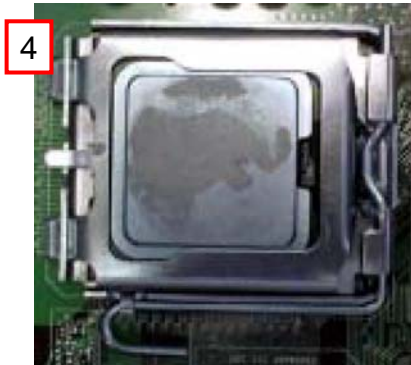
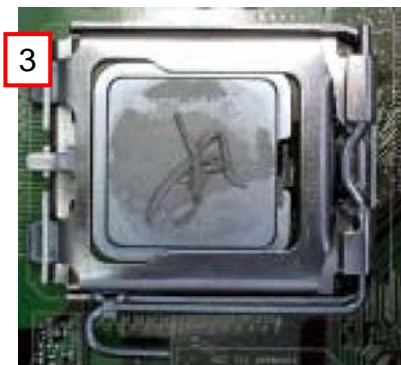
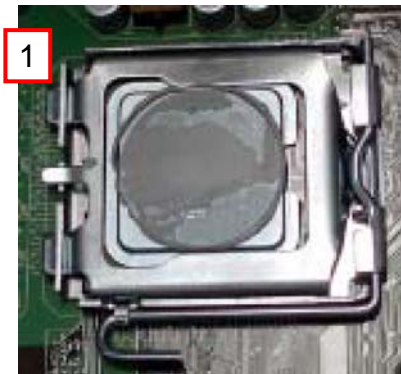

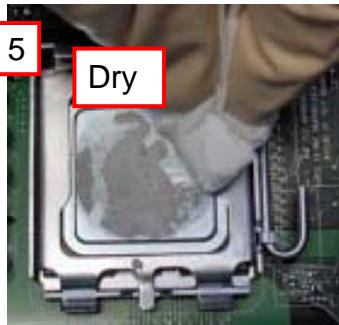

1. Remove the heatsink from the socket
2. Gently push loose thermal interface material (TIM) to center of processor (pictures 2 and 3)
3. Remove pieces with dry cloth (picture 4)
4. Wipe with dry, lint-free cloth to remove most of the material (picture 5)
5. Wet another lint-free cloth with isopropyl alcohol (IPA) and wipe to clean remaining material (picture 6)
6. Be careful to remove material from gaps between processor and load plate
7. For thermal grease removal use Step 4-6

## TIM and Grease Removal from Heat-sink

**Note:** Remove and replace the TIM from the heatsink if you are re-using the heatsink on a new processor

1. Use dry, lint-free cloth and wipe package to remove most of the material
2. Wet another lint-free cloth with isopropyl alcohol (IPA) and wipe heatsink to clean remaining material



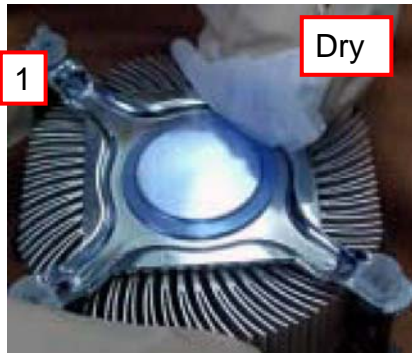

## Replacing Damaged Fasteners

- To prevent damage, avoid setting the thermal solution with the prongs down
  - Set on heatsink side or with fan down
- The plastic fasteners on the heatsink can be replaced.
  - Use Shop Intel to order spare fasteners
  - <http://www.shop-intel.com>
- To remove a damaged fastener

**Note:** Protective gloves are not required for this procedure

- Rotate the black pin counterclockwise until it “snaps”. There will be some resistance
- Remove the black pin from the white prong
- Tilt the white prong to remove it from the heatsink leg

Avoid damage, avoid placing prongs on hard surface

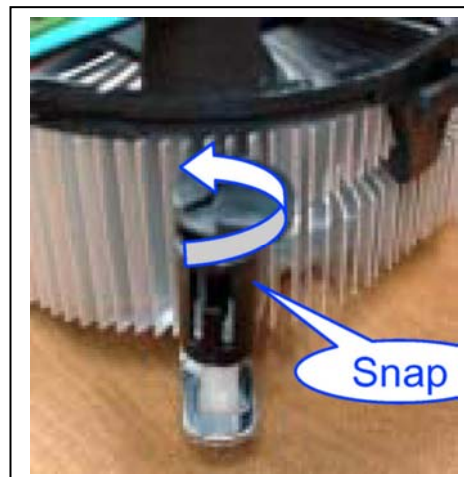

Damaged. Attempts to straighten not recommended

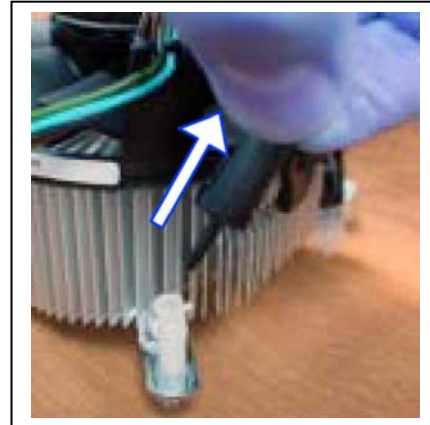

## Replacing Fasteners

- To **replace** the fastener
  - Start with the white prong
  - Note the “keying” notch feature
  - Tilt the prong to insert into the heatsink leg.
  - Holding the white prong without bending it, push the black pin on from the bottom until you hear a single “click”

Replacement

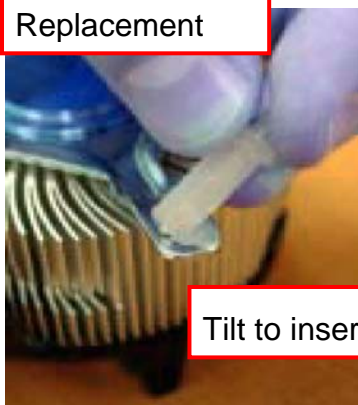

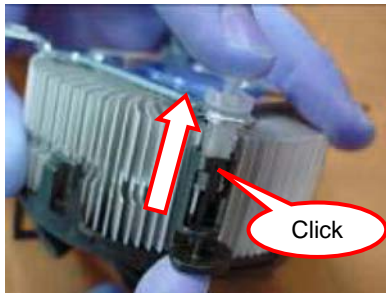

**Note:** The black pin and white prong will only “snap” on in one orientation

-Check to ensure the black pin is rotated properly for installation with the slot perpendicular to the heatsink

## 2-4 Install Memory

This motherboard provides two 240-pin DDR2 DUAL INLINE MEMORY MODULES (DIMM) sides for DDR2 memory expansion available from minimum memory size of 64MB to maximum memory size of 2.0GB DDR2 SDRAM.

### Valid Memory Configurations

Bank	240-pin DDR2 DIMM	PCS	Total Memory
Bank 0, 1 (DDR1)	DDRII533/DDRII400 DDR DRAM Module	X1	64MB~1.0GB
Bank 2, 3 (DDR2)	DDRII533/DDRII400 DDR DRAM Module	X1	64MB~1.0GB
Total	System Memory (Max. 2.0GB)	X2	64MB~2.0GB

Generally, installing DDR2 SDRAM modules to your motherboard is very easy, you can refer to figure 2-4 to see what a 240-pin DDR2 SDRAM module looks like.

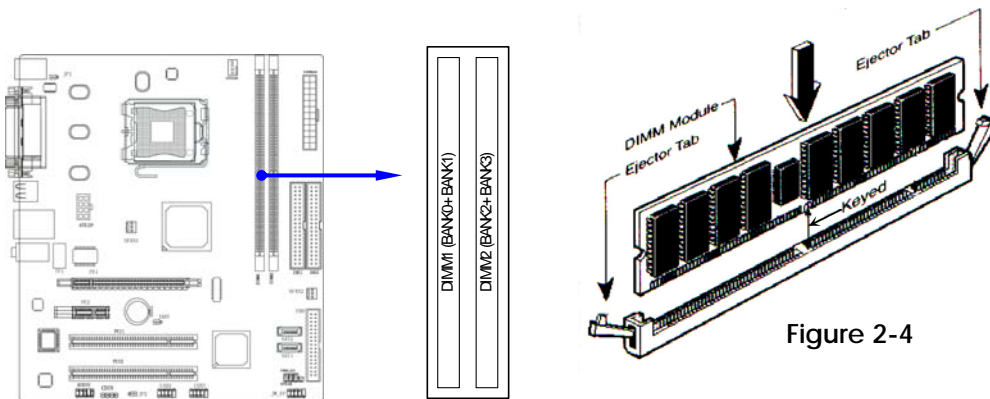

Figure 2-4

#### **NOTE!**

When you install DIMM module fully into the DIMM socket the eject tab should be locked into the DIMM module very firmly and fit into its indentation on both sides.

#### **WARNING!**

For the DDR SDRAM CLOCK is set at 133MHz, use only DDR2 533-compliant DDR2 Modules. When this motherboard operate at 133Mhz, most system will not even boot if non-compliant modules are used because of the strict timing issues, if your DDR Modules are not DDR2 533-compliant, set the SDRAM clock to 133MHz to ensure system stability.

---

---

## 2-5 Expansion Cards

**WARNING!** Turn off your power when adding or removing expansion cards or other system components. Failure to do so may cause severe damage to both your motherboard and expansion cards.

### 2-5-1 Procedure For Expansion Card Installation

1. Read the documentation for your expansion card and make any necessary hardware or software setting for your expansion card such as jumpers.
2. Remove your computer's cover and the bracket plate on the slot you intend to use.
3. Align the card's connectors and press firmly.
4. Secure the card on the slot with the screen you remove above.
5. Replace the computer system's cover.
6. Set up the BIOS if necessary.
7. Install the necessary software driver for your expansion card.

### 2-5-2 Assigning IRQs For Expansion Card

Some expansion cards need an IRQ to operate. Generally, an IRQ must exclusively assign to one use. In a standard design, there are 16 IRQs available but most of them are already in use.

#### Standard Interrupt Assignments

IRQ	Priority	Standard function
0	N/A	System Timer
1	N/A	Keyboard Controller
2	N/A	Programmable Interrupt
3 *	8	Communications Port (COM2)
4 *	9	Communications Port (COM1)
5 *	6	Sound Card (sometimes LPT2)
6 *	11	Floppy Disk Controller
7 *	7	Printer Port (LPT1)
8	N/A	System CMOS/Real Time Clock
9 *	10	ACPI Mode when enabled
10 *	3	IRQ Holder for PCI Steering
11 *	2	IRQ Holder for PCI Steering
12 *	4	PS/2 Compatible Mouse Port
13	N/A	Numeric Data Processor
14 *	5	Primary IDE Channel
15 *	1	Secondary IDE Channel

\* These IRQs are usually available for ISA or PCI devices.

---

---

### 2-5-3 PCI Express Slot

This motherboard provides one 16-lane PCI Express slot which offers 4Gbyte/sec data transfer rate at each relative direction intended for Video Graphics Array, and one x1 PCI Express Slot. Fully compliant to the *PCI Express Base Specification revision 1.0a*, support PCI Express VGA card, and other PCI Express device.

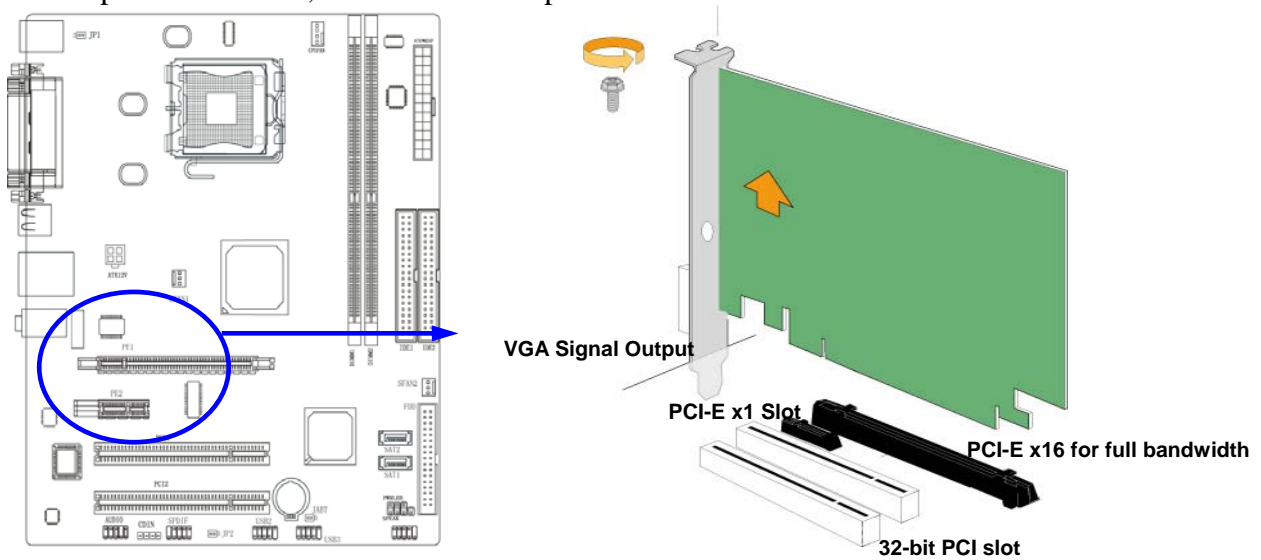

**IMPORTANT!** To install the single PCI EXPRESS x16 interface supported VGA card to get the full speed of x16 bandwidth in the PCI EXPRESS x16 slot as being marked above. If you utilize the EXPRESS x16 slot to support the VGA card as the external display, please disabled the integrated VGA card in BIOS.

---

---

## 2-6 Connectors, Headers

### 2-6-1 Connectors

#### (1) Power Connector (24-pin block) : ATXPWR24P

ATX Power Supply connector. This is a new defined 24-pins connector that usually comes with ATX case. The ATX Power Supply allows to use soft power on momentary switch that connect from the front panel switch to 2-pins Power On jumper pole on the motherboard. When the power switch on the back of the ATX power supply turned on, the full power will not come into the system board until the front panel switch is momentarily pressed. Press this switch again will turn off the power to the system board.

- \*\* We recommend that you use an ATX 12V Specification 2.0-compliant power supply unit (PSU) with a minimum of 350W power rating. This type has 24-pin and 4 / 8-pin power plugs.
- \*\* If you intend to use a PSU with 20-pin and 4-pin power plugs, make sure that the 20-pin power plug can provide at least 15A on +12V and the power supply unit has a minimum power rating of 350W. The system may become unstable or may not boot up if the power is inadequate.

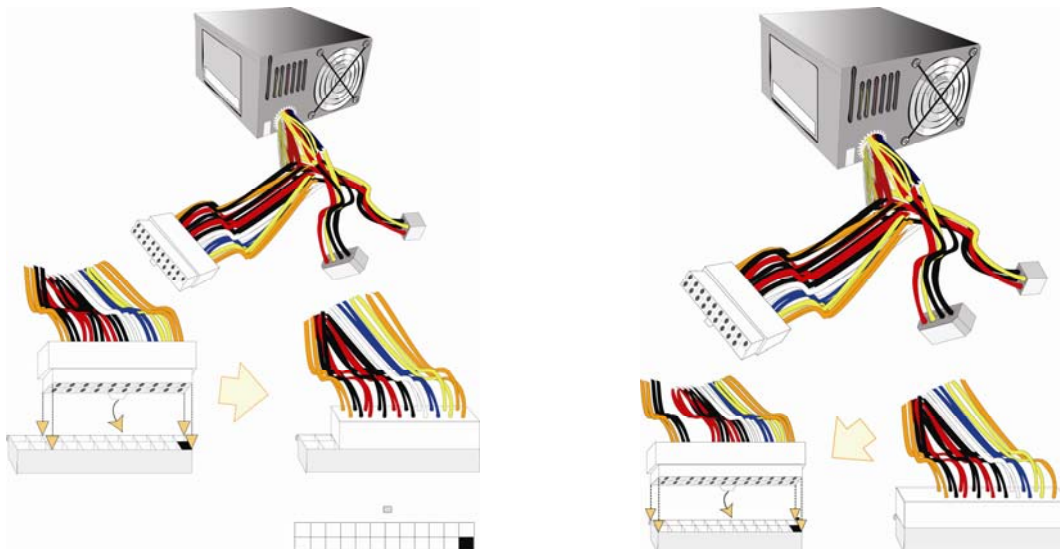
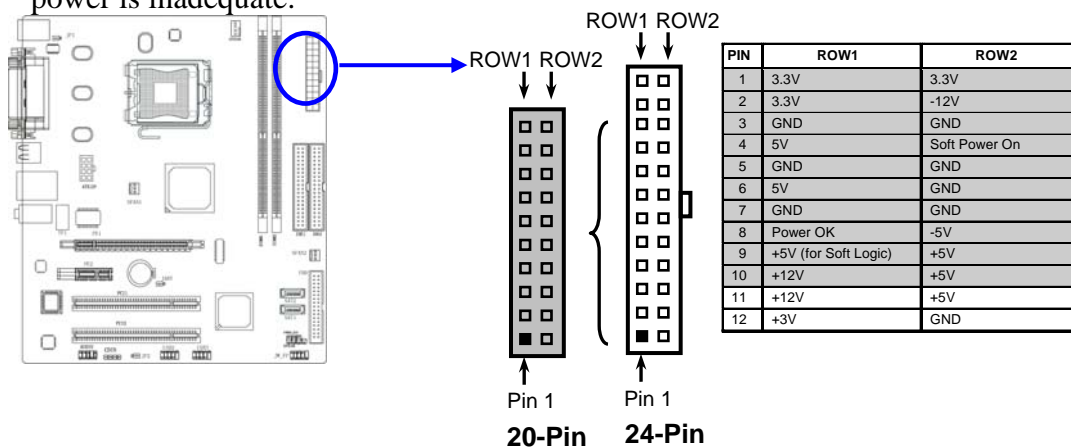

---

---

(2) **ATX 12V Power Connector (8-pin block) : ATX12V**

This is a new defined 8-pins connector that usually comes with ATX Power Supply. The ATX Power Supply which fully support Pentium 4 processor must including this connector for support extra 12V voltage to maintain system power consumption. Without this connector might cause system unstable because the power supply can not provide sufficient current for system.

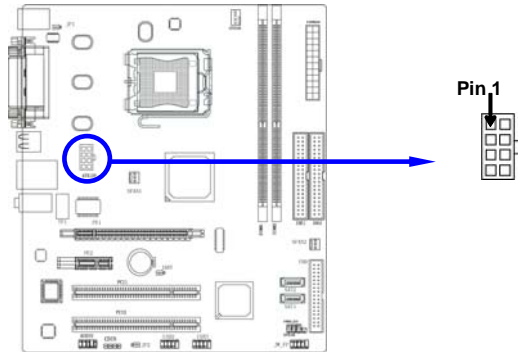

(3) **PS/2 Mouse & PS/2 Keyboard Connector: PS2KBMS**

The connectors for PS/2 keyboard and PS/2 Mouse.

(4) **USB Port connector: USB1**

The connectors are 4-pin connector that connect USB devices to the system board.

(5) **LAN Port connector: UL1**

This connector is optional standard RJ45 connector for Network

(6) **Parallel Port Connector (25-pin female): PARALLEL**

Parallel Port connector is a 25-pin D-Subminiature Receptacle connector. The On-board Parallel Port can be disabled through the BIOS SETUP. Please refer to Chapter 3 “INTEGRATED PERIPHERALS SETUP” section for more detail information.

(7) **Audio Connector : CN1(LINE-OUT/ LINE\_IN/MIC)**

This Connector are 3 phone Jack for LINE-OUT, LINE-IN, MIC.

**Line-out :** Audio output to speaker

**Line-in :** Audio input to sound chip

**MIC :** Microphone Connector

(8) **Serial Port COM1 : COM1**

COM1 is the 9-pin D-Subminiature male connector. The On-board serial port can be disabled through BIOS SETUP. Please refer to Chapter 3 “INTEGRATED PERIPHERALS SETUP” section for more detail information.

---

**(9) VGA Connector (15-pin D-Sub) Connector: VGA1**

VGA is the 15-pin D-Subminiature female connector for display monitor.

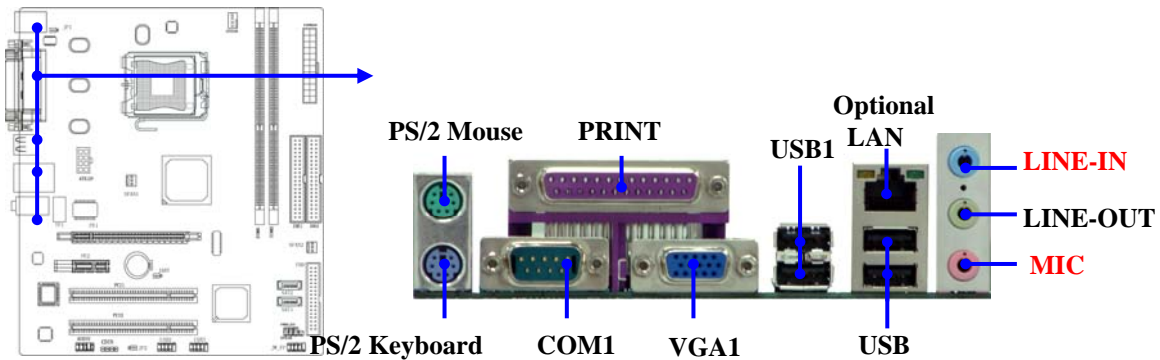

**(10) Floppy drive Connector (34-pin block): FDD**

This connector supports the provided floppy drive ribbon cable. After connecting the single plug end to motherboard, connect the two plugs at other end to the floppy drives.

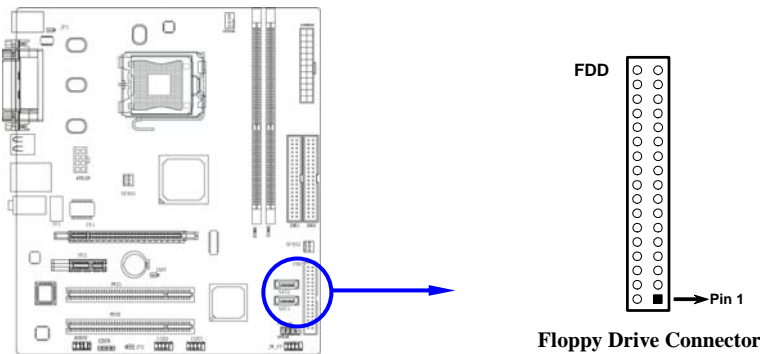

**(11) Primary IDE Connector (40-pin block): IDE1**

This connector supports the provided IDE hard disk ribbon cable. After connecting the single plug end to motherboard, connect the two plugs at other end to your hard disk(s). If you install two hard disks, you must configure the second drive to Slave mode by setting its jumpers accordingly. Please refer to the documentation of your hard disk for the jumper settings.

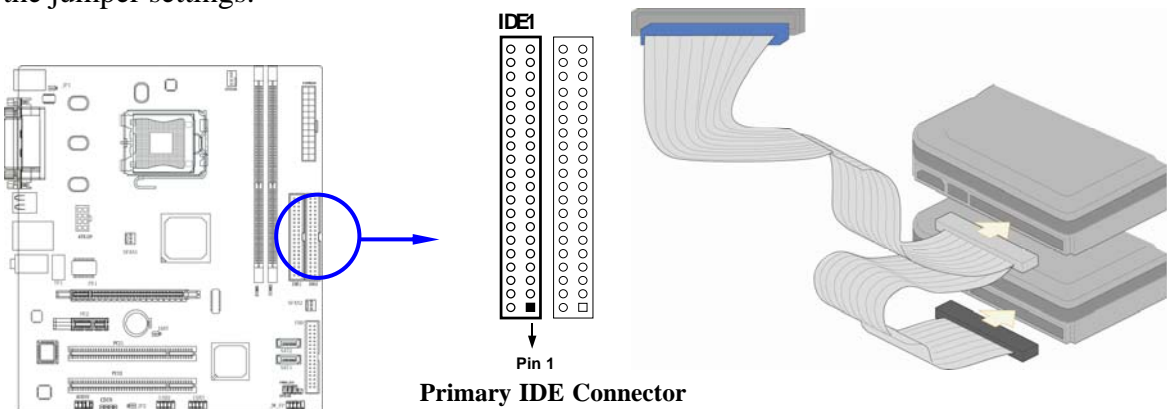

---

---

**(12) Secondary IDE Connector (40-pin block): IDE2**

This connector connects to the next set of Master and Slave hard disks. Follow the same procedure described for the primary IDE connector. You may also configure two hard disks to be both Masters using one ribbon cable on the primary IDE connector and another ribbon cable on the secondary IDE connector.

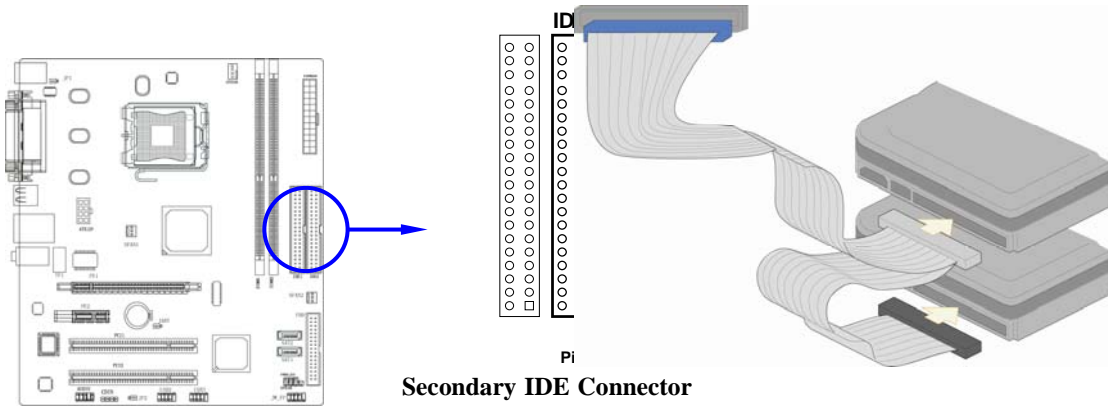

- Two hard disks can be connected to each connector. The first HDD is referred to as the “Master” and the second HDD is referred to as the “Slave”.
- For performance issues, we strongly suggest you don’t install a CD-ROM or DVD-ROM drive on the same IDE channel as a hard disk. Otherwise, the system performance on this channel may drop.

**(13) Serial-ATA Port connector: SATA1 / SATA2**

The connectors support **Serial ATA** hard disk drives with cables for connecting the motherboard and serial ATA hard disk drives.

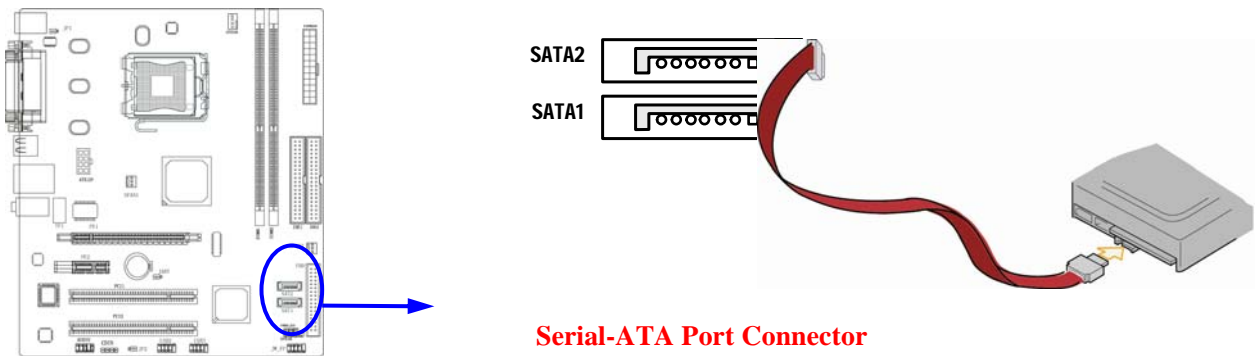

---

---

## 2-6-2 Headers

### (1) MIC Header for Front Panel (9-pin): AUDIO

This header connect to Front Panel Line-out, MIC connector with cable.

Without install the cable, this header default setting is 5-6 short, 9-10 short. When you install the cable you have take off these jumpers.

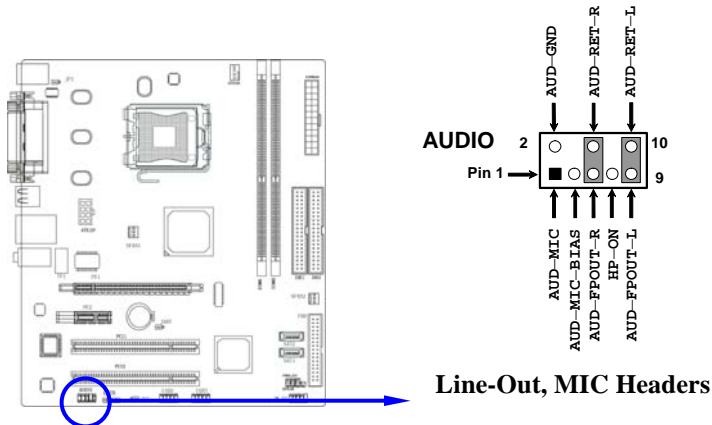

### (2) USB Port Headers (9-pin) : USB2/USB3

These headers are used for connecting the additional USB port plug. By attaching an option USB cable, your can be provided with two additional USB plugs affixed to the back panel.

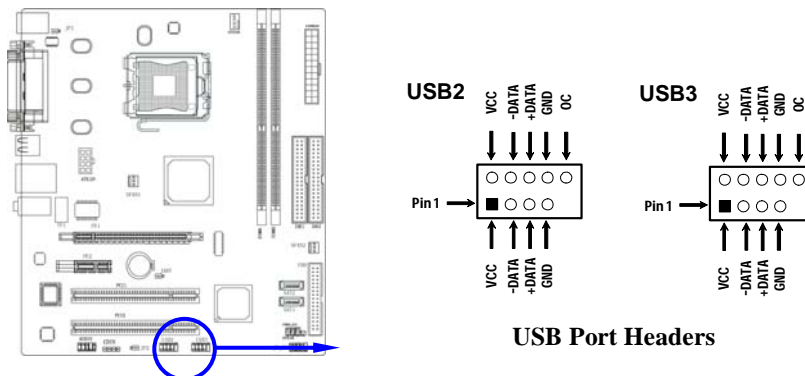

### (3) IDE Activity LED: HD LED

This connector connects to the hard disk activity indicator light on the case.

### (4) Reset switch lead: RESET

This 2-pin connector connects to the case-mounted reset switch for rebooting your computer without having to turn off your power switch. This is a preferred method of rebooting in order to prolong the life of the system's power supply. See the figure below.

### (5) PC Speaker connector: SPEAK

This 4-pin connector connects to the case-mounted speaker. See the figure below.

**(6) Power LED: PWR LED**

The Power LED is light on while the system power is on. Connect the Power LED from the system case to this pin.

**(7) Power switch: PWR BTN**

This 2-pin connector connects to the case-mounted power switch to power ON/OFF the system.

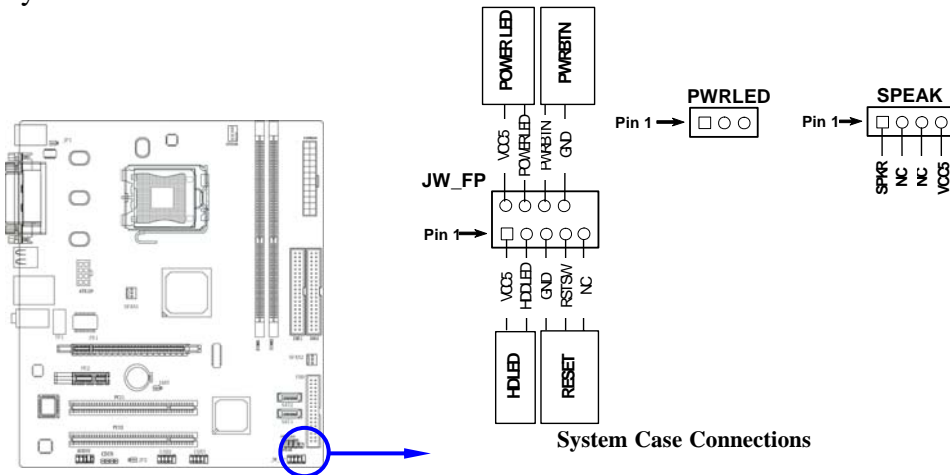

**(8) FAN Headers: SFAN1(3-pin), SFAN2(3-pin), CPUFAN(4-pin)**

These connectors support cooling fans of 350mA (4.2 Watts) or less, depending on the fan manufacturer, the wire and plug may be different. The red wire should be positive, while the black should be ground. Connect the fan's plug to the board taking into consideration the polarity of connector.

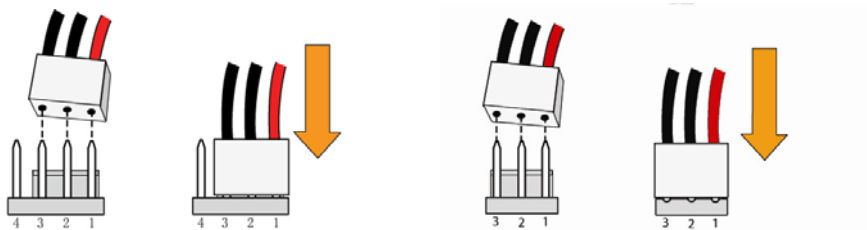
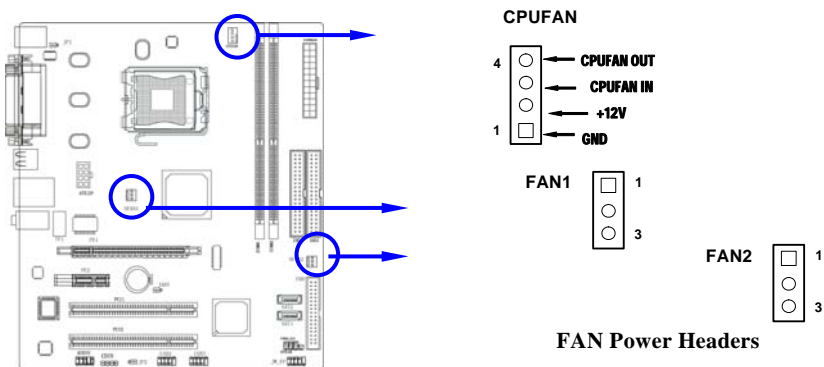

---

**(9) CD Audio-In Headers (4-pin) : CDIN**

CDIN are the connectors for CD-Audio Input signal. Please connect it to CD-ROM CD-Audio output connector.

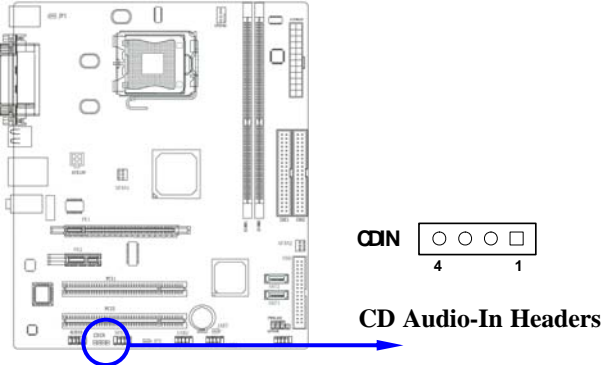

---

---

## 2-7 Starting Up Your Computer

1. After all connection are made, close your computer case cover.
2. Be sure all the switch are off, and check that the power supply input voltage is set to proper position, usually in-put voltage is 220V~240V or 110V~120V depending on your country's voltage used.
3. Connect the power supply cord into the power supply located on the back of your system case according to your system user's manual.
4. Turn on your peripheral as following order:
  - a. Your monitor.
  - b. Other external peripheral (Printer, Scanner, External Modem etc...)
  - c. Your system power. For ATX power supplies, you need to turn on the power supply and press the ATX power switch on the front side of the case.
5. The power LED on the front panel of the system case will light. The LED on the monitor may light up or switch between orange and green after the system is on. If it complies with green standards or if it is has a power standby feature. The system will then run power-on test. While the test are running, the BIOS will alarm beeps or additional message will appear on the screen.

If you do not see any thing within 30 seconds from the time you turn on the power. The system may have failed on power-on test. Recheck your jumper settings and connections or call your retailer for assistance.

Beep	Meaning
One short beep when displaying logo	No error during POST
Long beeps in an endless loop	No DRAM install or detected
One long beep followed by three short beeps	Video card not found or video card memory bad
High frequency beeps when system is working	CPU overheated System running at a lower frequency

6. During power-on, press <Delete> key to enter BIOS setup. Follow the instructions in BIOS SETUP.
7. **Power off your computer:** You must first exit or shut down your operating system before switch off the power switch. For ATX power supply, you can press ATX power switching after exiting or shutting down your operating system. If you use Windows 9X, click "**Start**" button, click "**Shut down**" and then click "**Shut down the computer?**" The power supply should turn off after windows shut down.

---

---

## Chapter 3

### Introducing BIOS

The BIOS is a program located on a Flash Memory on the motherboard. This program is a bridge between motherboard and operating system. When you start the computer, the BIOS program gain control. The BIOS first operates an auto-diagnostic test called POST (power on self test) for all the necessary hardware, it detects the entire hardware device and configures the parameters of the hardware synchronization. Only when these tasks are completed done it gives up control of the computer to operating system (OS). Since the BIOS is the only channel for hardware and software to communicate, it is the key factor for system stability, and in ensuring that your system performance as its best.

In the BIOS Setup main menu of Figure 3-1, you can see several options. We will explain these options step by step in the following pages of this chapter, but let us first see a short description of the function keys you may use here:

- Press <Esc> to quit the BIOS Setup.
- Press ↑↓←→ (up, down, left, right) to choose, in the main menu, the option you want to confirm or to modify.
- Press <F10> when you have completed the setup of BIOS parameters to save these parameters and to exit the BIOS Setup menu.
- Press Page Up/Page Down or +/- keys when you want to modify the BIOS parameters for the active option.

### 3-1 Entering Setup

Power on the computer and by pressing <Del> immediately allows you to enter Setup.

If the message disappears before your respond and you still wish to enter Setup, restart the system to try again by turning it OFF then ON or pressing the “RESET” button on the system case. You may also restart by simultaneously pressing <Ctrl>, <Alt> and <Delete> keys. If you do not press the keys at the correct time and the system does not boot, an error message will be displayed and you will again be asked to

**Press <F1> to continue, <Ctrl-Alt-Esc> or <Del> to enter Setup**

### 3-2 Getting Help

#### Main Menu

The on-line description of the highlighted setup function is displayed at the bottom of the screen.

#### Status Page Setup Menu/Option Page Setup Menu

Press F1 to pop up a small help window that describes the appropriate keys to use and the possible selections for the highlighted item. To exit the Help Window, press <Esc>.

---

---

### 3-3 The Main Menu

Once you enter Award® BIOS CMOS Setup Utility, the Main Menu (Figure 3-1) will appear on the screen. The Main Menu allows you to select from fourteen setup functions and two exit choices. Use arrow keys to select among the items and press <Enter> to accept or enter the sub-menu.

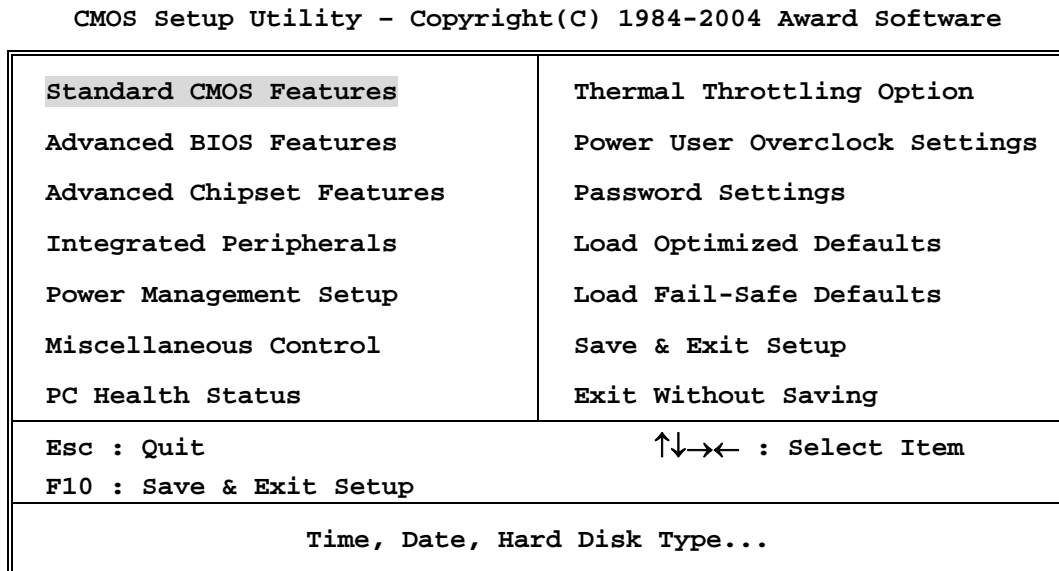

Figure 3-1

#### Standard CMOS Features

Use this Menu for basic system configurations.

#### Advanced BIOS Features

Use this menu to set the Advanced Features available on your system.

#### Advanced Chipset Features

Use this menu to change the values in the chipset registers and optimize your system's performance.

#### Integrated Peripherals

Use this menu to specify your settings for integrated peripherals.

#### Power Management Setup

Use this menu to specify your settings for power management.

#### PnP/PCI configurations

This entry appears if your system supports PnP/PCI.

#### PC Health Status

This entry shows your PC health status.

#### Miscellaneous Control

Use this menu to specify your settings for Miscellaneous control.

---

---

### Load Optimized Defaults

Use this menu to load the BIOS default values these are setting for optimal performances system operations for performance use.

### Load Standard Defaults

Use this menu to load the BIOS default values for the stable performance system operation that are factory settings for normal use.

### Set Supervisor/User Password

Use this menu to set User and Supervisor Passwords.

### Save & Exit Setup

Save CMOS value changes to CMOS and exit setup.

### Exit Without Saving

Abandon all CMOS value changes and exit setup.

## 3-4 Standard CMOS Features

The items in Standard CMOS Setup Menu are divided into several categories. Each category includes no, one or more than one setup items. Use the arrow keys to highlight the item and then use the <PgUp> or <PgDn> keys to select the value you want in each item.

CMOS Setup Utility - Copyright(C) 1984-2004 Award Software  
Standard CMOS Features

Date (mm:dd:yy)	Time (hh:mm:ss)	Item Help
> IDE Channel 0 Master	Press Enter None	Menu Level >  Change the day, month, year and century
> IDE Channel 0 Slave	Press Enter None	
> IDE Channel 1 Master	Press Enter None	
> IDE Channel 1 Slave	Press Enter None	
> SATA Channel 1	None	
> SATA Channel 2	None	
Drive A	1.44M, 3.5 in.	
Drive B	None	
Video	EGA/VGA	
Halt On	All,But Keyboard	
Base Memory	640K	
Extended Memory	56320K	
Total Memory	57344K	
↑↓→← Move Enter:Select +/-/PU/PD:Value F10:Save ESC:Exit F1:General Help F5:Previous Values F6:Optimized Defaults F7:Standard Defaults		

### Date

The date format is <day><month><date><year>.

**Day** Day of the week, from Sun to Sat, determined by BIOS. Read-only.

**Month** The month from Jan. through Dec.

**Date** The date from 1 to 31 can be keyed by numeric function keys.

**Year** The year depends on the year of the BIOS.

---

---

## Time

The time format is <hour><minute><second>.

## Primary Master/Primary Slave

## Secondary Master/Secondary Slave

Press PgUp/<+> or PgDn/<-> to select Manual, None, Auto type. Note that the specifications of your drive must match with the drive table. The hard disk will not work properly if you enter improper information for this category. If your hard disk drive type is not matched or listed, you can use Manual to define your own drive type manually.

If you select Manual, related information is asked to be entered to the following items. Enter the information directly from the keyboard. This information should be provided in the documentation from your hard disk vendor or the system manufacturer.

If the controller of HDD interface is SCSI, the selection shall be "None".

If the controller of HDD interface is CD-ROM, the selection shall be "None".

**Access Mode** The settings are Auto Normal, Large, and LBA.

**Cylinder** number of cylinders

**Head** number of heads

**Precomp** write precomp

**Landing Zone** landing zone

**Sector** number of sectors

## 3-5 Advanced BIOS Features

CMOS Setup Utility - Copyright(C) 1984-2004 Award Software

### Advanced BIOS Features

CPU Feature	Press Enter	
Hard Disk Boot Priority	Press Enter	Item Help
Virus Warning	Disabled	
CPU L1 Cache & L2 Cache	Enabled	
Hyper-Threading Technology	Enabled	Menu Level >
CPU L2 Cache ECC Checking	Enabled	
Quick Power On Self Test	Enabled	
First Boot Device	Floppy	
Second Boot Device	HDD-0	
Third Boot Device	CDROM	
Boot other Device	Enabled	
Boot Up Floppy Seek	Enabled	
Boot Up NumLock Status	On	
Typematic Rate Setting	Disabled	
Typematic Rate (Chars/Sec)	6	
Typematic Delay (Msec)	250	
Security Option	Setup	
MPS Version Control For OS	1.4	
OS Select For DRAM > 64MB	Non-OS2	
Video BIOS Shadow	Enabled	
Small Logo(EPA) Show	Disabled	
↑↓→← Move Enter:Select +/-/PU/PD:Value F10:Save ESC:Exit F1:General Help F5:Previous Values F6:Optimized Defaults F7:Standard Defaults		

---

---

### Anti-Virus Protection

Allows you to choose the VIRUS Warning feature for IDE Hard Disk boot sector protection. If this function is enabled and someone attempt to write data into this area, BIOS will show a warning message on screen and alarm beep.

**Disabled** (default) No warning message to appear when anything attempts to access the boot sector or hard disk partition table.

**Enabled** Activates automatically when the system boots up causing a warning message to appear when anything attempts to access the boot sector of hard disk partition table.

### CPU Internal Cache

The default value is Enabled.

**Enabled** (default) Enable cache

**Disabled** Disable cache

*Note: The internal cache is built in the processor.*

### External Cache

Choose Enabled or Disabled. This option enables the Level 2 cache memory.

### CPU L2 Cache ECC Checking

Choose Enabled or Disabled. This option enables the Level 2 cache memory ECC (error check correction).

### Quick Power On Self-Test

This category speeds up Power On Self Test (POST) after you power on the computer. If this is set to Enabled. BIOS will shorten or skip some check items during POST.

**Enabled** (default) Enable quick POST

**Disabled** Normal POST

### First/Second/Third/Fourth Boot Device

The BIOS attempts to load the operating system from the devices in the sequence selected in these items. The settings are Floppy, LS/ZIP, HDD-0/HDD-1/HDD-3, SCSI, CDROM, LAD and Disabled.

### Swap Floppy Drive

Switches the floppy disk drives between being designated as A and B. Default is Disabled.

### Boot Up Floppy Seek

During POST, BIOS will determine if the floppy disk drive installed is 40 or 80 tracks. 360K type is 40 tracks while 760K, 1.2M and 1.44M are all 80 tracks.

### Boot Up NumLock Status

The default value is On.

**On** (default) Keypad is numeric keys.

**Off** Keypad is arrow keys.

### Typematic Rate Setting

Keystrokes repeat at a rate determined by the keyboard controller. When enabled, the typematic rate and typematic delay can be selected. The settings are: Enabled/Disabled.

---

---

### Typematic Rate (Chars/Sec)

Sets the number of times a second to repeat a keystroke when you hold the key down. The settings are: 6, 8, 10, 12, 15, 20, 24, and 30.

### Typematic Delay (Msec)

Sets the delay time after the key is held down before it begins to repeat the keystroke. The settings are 250, 500, 750, and 1000.

### Security Option

This category allows you to limit access to the system and Setup, or just to Setup.

- System**            The system will not boot and access to Setup will be denied if the correct password is not entered at the prompt.
- Setup (default)**   The system will boot, but access to Setup will be denied if the correct password is not entered prompt.

### OS Select For DRAM > 64MB

Allows OS2® to be used with >64MB or DRAM. Settings are Non-OS/2 (default) and OS2. Set to OS/2 if using more than 64MB and running OS/2®.

## 3-6 Advanced Chipset Features

The Advanced Chipset Features Setup option is used to change the values of the chipset registers. These registers control most of the system options in the computer.

CMOS Setup Utility - Copyright(C) 1984-2004 Award Software

### Advanced Chipset Features

> Clock/Drive Control	Press Enter	Item Help
> AGP&P2P Bridge Control	Press Enter	
> CPU&PCI Bus Control	Press Enter	
Memory Hole	Disabled	Menu Level >
System BIOS Cacheable	Enabled	
Top performance	Disabled	
↑↓→← Move Enter:Select +/-/PU/PD:Value F10:Save ESC:Exit F1:General Help F5:Previous Values F6:Optimized Defaults F7:Standard Defaults		

#### Clock/Drive Control

Please refer to section 3-6-1

#### AGP&P2P Bridge Control

Please refer to section 3-6-2

#### CPU&PCI Bus Control

Please refer to section 3-6-3

---

---

### System BIOS Cacheable

Selecting Enabled allows caching of the system BIOS ROM at F0000h-FFFFFh, resulting in better system performance. However, if any program writes to this memory area, a system error may result. The settings are: Enabled and Disabled.

### Video RAM Cacheable

Select Enabled allows caching of the video BIOS, resulting in better system performance. However, if any program writes to this memory area, a system error may result. The settings are: Enabled and Disabled.

### Memory Hole

You can reserve this area of system memory for ISA adapter ROM. When this area is reserved, it cannot be cached. The user information of peripherals that need to use this area of system memory usually discusses their memory requirements. The settings are: Enabled and Disabled.

## 3-6-1 DRAM Clock/Drive Control

CMOS Setup Utility - Copyright(C) 1984-2004 Award Software

### DRAM Timing Settings

Current FSB Frequency	200MHz	Item Help
Current DRAM Frequency	266Mhz	
DRAM Clock	By SPD	
DRAM Timing	Auto By SPD	Menu Level >>
IT CMD Support	Disabled	
↑↓→← Move Enter:Select +/-/PU/PD:Value F10:Save ESC:Exit F1:General Help F5:Previous Values F6:Optimized Defaults F7:Standard Defaults		

### RAS Active Time

This field let's you insert a timing delay between the CAS and RAS strobe signals, used when DRAM is written to, read from, or refreshed. *Fast* gives faster performance; and *Slow* gives more stable performance. This field applies only when synchronous DRAM is installed in the system. The settings are: 2T and 3T.

### RAS Precharge Time

If an insufficient number of cycles is allowed for the RAS to accumulate its charge before DRAM refresh, the refresh may be incomplete and the DRAM may fail to retain date. *Fast* gives faster performance; and *Slow* gives more stable performance. This field applies only when synchronous DRAM is installed in the system. The settings are: 2T and 3T.

### CAS Latency

When synchronous DRAM is installed, the number of clock cycles of CAS latency depends on the DRAM timing. The settings are: 2T and 2.5T.

---

---

## 3-6-2 AGP &P2P Bridge Control

CMOS Setup Utility - Copyright(C) 1984-2004 Award Software

### AGP Timing Settings

AGP Aperture Size	128M	Item Help
AGP 2.0 Mode	4X	
AGP Master 1 WS Write	Enabled	
AGP Master 1 WS Read	Enabled	Menu Level >>
VGA Share Memory Size	64M-----	
Direct Frame Buffer	Disabled	
↑↓→← Move Enter:Select +/-/PU/PD:Value F10:Save ESC:Exit F1:General Help F5:Previous Values F6:Optimized Defaults F7:Standard Defaults		

*Note: Change these settings only if you are familiar with the chipset.*

## 3-6-3 CPU&PCI Bus Control

CMOS Setup Utility - Copyright(C) 1984-2004 Award Software

### PCI Timing Settings

PCI Master 0 WS Write	Disabled	Item Help
PCI Delay Transaction	Disabled	
VLink Mode Selection	By Auto	
VLink 8X Support	Enabled	Menu Level >>
VIA PWR Management	Enabled	
↑↓→← Move Enter:Select +/-/PU/PD:Value F10:Save ESC:Exit F1:General Help F5:Previous Values F6:Optimized Defaults F7:Standard Defaults		

### PCI Delay Transaction

The chipset has an embedded 32-bit posted write buffer to support delay transactions cycles. Select Enabled to support compliance with PCI specification version 2.1. The settings are: Enabled and Disabled.

## 3-7 Integrated Peripherals

CMOS Setup Utility - Copyright(C) 1984-2004 Award Software

### Integrated Peripherals

> VIA OnChip IDE Device	Press Enter	Item Help
> VIA OnChip PCI Device	Press Enter	
> Super IO Device	Press Enter	Menu Level >
Init Display First	PCIEX	
↑↓→← Move Enter:Select +/-/PU/PD:Value F10:Save ESC:Exit F1:General Help F5:Previous Values F6:Optimized Defaults F7:Standard Defaults		

### VIA OnChip IDE Device

Please refer to section 3-7-1

### VIA OnChip PCI Device

Please refer to section 3-7-2

### Super IO Device

Please refer to section 3-7-3

### Init Display First

This item allows you to decide to activate whether PCI Slot or AGP VGA first. The settings are: PCI Slot, AGP Slot.

## 3-7-1 VIA OnChip IDE Device

CMOS Setup Utility - Copyright(C) 1984-2004 Award Software

### OnChip IDE Function

OnChip SATA	Enabled	Item Help
SATA Mode	IDE	
IDE DMA Transfer Access	Disabled	Menu Level >>
Onchip IDE Channel0	Enabled	
Onchip IDE Channell	Enabled	
IDE prefetch Mode	Enabled	
Primary Master PIO	Auto	
Primary Slave PIO	Auto	
Secondary Master PIO	Auto	
Secondary Slave PIO	Auto	
Primary Master UDMA	Auto	
Primary Slave UDMA	Auto	
Secondary Master UDMA	Auto	
Secondary Slave UDMA	Auto	
IDE HDD Block Mode	Enabled	
↑↓→← Move Enter:Select +/-/PU/PD:Value F10:Save ESC:Exit F1:General Help F5:Previous Values F6:Optimized Defaults F7:Standard Defaults		

---

---

### OnChip IDE Channel0/Channel1

The integrated peripheral controller contains an IDE interface with support for two IDE channels. Select *Enabled* to activate each channel separately. The settings are: Enabled and Disabled.

### Primary/Secondary Master/Slave PIO

The four IDE PIO (Programmed Input/Output) fields let you set a PIO mode (0-4) for each of the IDE devices that the onboard IDE interface supports. Modes 0 through 4 provide successively increased performance. In Auto mode, the system automatically determines the best mode for each device. The settings are: Auto, Mode 0, Mode 1, Mode 2, Mode 3, Mode 4.

### Primary/Secondary Master/Slave UDMA

Ultra DMA/33 implementation is possible only if your IDE hard drive supports it and the operating environment includes a DMA driver (Windows 95 OSR2 or a third-party IDE bus master driver). If your hard drive and your system software both support Ultra DMA/33 and Ultra DMA/66, select Auto to enable BIOS support. The settings are: Auto, Disabled.

### IDE HDD Block Mode

Block mode is also called block transfer, multiple commands, or multiple sector read/write. If your IDE hard drive supports block mode (most new drives do), select Enabled for automatic detection of the optimal number of block read/writes per sector the drive can support. The settings are: Enabled, Disabled.

## 3-7-2 VIA OnChip PCI Device

CMOS Setup Utility - Copyright(C) 1984-2004 Award Software

### OnChip Device Function

MAC Address	00-30-18-00-00-10	Item Help	
AC97 Audio	Auto	Menu Level >>	
Onboard LAN	Auto		
AC97 Sound Device	Auto		
VIA-6103 MAC Address Input	Press Enter		
Onboard LAN Boot ROM	Disabled		
Onchip USB Controller	ALL Enabled		
Onchip EHCI Controller	Enabled		
USB Emulation	Off		
↑↓→← Move Enter:Select +/-/PU/PD:Value F10:Save ESC:Exit F1:General Help F5:Previous Values F6:Optimized Defaults F7:Standard Defaults			

### AC97 Sound Device

This item allows you to decide to enable/disable the chipset family to support AC97 Audio. The settings are: Enabled, Disabled.

### USB Host Controller

Select *Enabled* if your system contains a Universal Serial Bus (USB) controller and you have a USB peripherals. The settings are: Enabled, Disabled.

---

---

## USB Keyboard Support

Select *Enabled* if your system contains a Universal Serial Bus (USB) controller and you have a USB keyboard. The settings are: Enabled, Disabled.

## 3-7-3 Super IO Device

CMOS Setup Utility - Copyright(C) 1984-2004 Award Software

### Onboard Super IO Function

Onboard FDD Controller	<b>Enabled</b>	Item Help
Onboard Serial Port 1	3F8/IRQ4	
Onboard Serial Port 2	2F8/IRQ3	
VART Mode Select	Normal	Menu Level >>
Onboard Parallel Port	378/IRQ7	
Parallel Port Mode	SPP	
ECP Mode Use DMA	3	
PWRON After PWR-Fail	Off	

↑↓←→ Move Enter:Select +/-/PU/PD:Value F10:Save ESC:Exit F1:General Help  
F5:Previous Values F6:Optimized Defaults F7:Standard Defaults

### Onboard FDD Controller

Select Enabled if your system has a floppy disk controller (FDD) installed on the system board and you wish to use it. If you install add-on FDC or the system has no floppy drive, select Disabled in this field. The settings are: Enabled and Disabled.

### Onboard Serial Port 1/Port 2

Select an address and corresponding interrupt for the first and the second serial ports. The settings are: 3F8/IRQ4, 2E8/IRQ3, 3E8/IRQ4, 2F8/IRQ3, Disabled, Auto.

### Onboard Parallel Port

There is a built-in parallel port on the on-board Super I/O chipset that Provides Standard, ECP, and EPP features. It has the following option:

#### Disabled

- (3BCH/IRQ7)/ Line Printer port 0
- (278H/IRQ5)/ Line Printer port 2
- (378H/IRQ7) Line Printer port 1

### Parallel Port Mode

- SPP : Standard Parallel Port
- EPP : Enhanced Parallel Port
- ECP : Extended Capability Port

#### SPP/EPP/ECP/ECP+EPP

To operate the onboard parallel port as Standard Parallel Port only, choose "SPP." To operate the onboard parallel port in the EPP modes simultaneously, choose "EPP." By choosing "ECP", the onboard parallel port will operate in ECP mode only. Choosing "ECP+EPP" will allow the onboard parallel port to support both the ECP and EPP modes simultaneously. The ECP mode has to use the DMA channel, so choose the onboard parallel port with the ECP feature. After selecting it, the following message will appear: "ECP Mode Use DMA" at this time, the user can choose between DMA channels 3 to 1. The onboard

parallel port is EPP Spec. compliant, so after the user chooses the onboard parallel port with the EPP function, the following message will be displayed on the screen: "EPP Mode Select." At this time either EPP 1.7 spec. or EPP 1.9 spec. can be chosen.

### 3-8 Power Management Setup

The Power Management Setup allows you to configure your system to most effectively save energy saving while operating in a manner consistent with your own style of computer use.

CMOS Setup Utility - Copyright(C) 1984-2004 Award Software

#### Power Management Setup

ACPI Function	Enabled	Item Help
ACPI Suspend Type	S1(DOS)	
Power management option	User Define	
HDD Power Down	Disable	Menu Level >
Suspend Mode	Disabled	
Video off Option	Suspend->off	
Video off method	V/H SYNC+Blank	
Modem use IRQ	3	
Soft-off by PWRBTN	Instant-off	
Run VGABIOS If S3 Resume	Auto	
AC loss Auto Restart	Off	
> IRQ/Event Activity Detect	Press Enter	
↑↓→← Move Enter:Select +/-/PU/PD:Value F10:Save ESC:Exit F1:General Help F5:Previous Values F6:Optimized Defaults F7:Standard Defaults		

#### ACPI Function

This item allows you to Enabled/Disabled the Advanced Configuration and Power Management (ACPI). The settings are Enabled and Disabled.

#### Video Off Option

This determines the manner in which the monitor is blanked. The choice are Suspend → off, All Modes → Off, and Always On.

#### Video Off Method

This determines the manner in which the monitor is blanked.

- DPMS (default)** Initial display power management signaling.
- Blank Screen** This option only writes blanks to the video buffer.
- V/H SYNC+Blank** This selection will cause the system to turn off the vertical and horizontal synchronization ports and write blanks to the video buffer.

#### Modem Use IRQ

This determines the IRQ in which the MODEM can use.  
The settings are: 3, 4, 5, 7, 9, 10, 11, NA.

#### Power Button Function

Pressing the power button for more than 4 seconds forces the system to enter the Soft-Off state. The settings are: Delay 4 Sec, Instant-Off.

#### Wake Up Events

Please refer to section 3-8-1

---

---

## 3-8-1 IRQ/Event Activity Detect

CMOS Setup Utility - Copyright(C) 1984-2004 Award Software

### Wake Up Events

	Hotkey	Item Help
PS2KB Wakeup Select	Disabled	
PS2KB Wakeup From S3/S4/S5	Disabled	
PS2MS Wakeup From S3/S4/S5	Disabled	
USB Resume from S3	Enabled	
VGA OFF	On	Menu Level >>
LPT&COM	LPT/COM	
HDD&FDD	On	
PCI Master	OFF	
Power on by PCI Card	Disabled	
Modem Ring Resume	Disabled	
RTC Alarm Resume	Disabled	
IRQs Activity Monitoring	Press Enter	

↑↓→← Move Enter:Select +/-/PU/PD:Value F10:Save ESC:Exit F1:General Help  
F5:Previous Values F6:Optimized Defaults F7:Standard Defaults

### Wake Up On Ring/PME

During Disabled, the system will ignore any incoming call from the modem. During Enabled, the system will boot up if there's an incoming call from the modem.

### Wake-Up on RTC Alarm

This function is for setting date and time for your computer to boot up. During Disabled, you cannot use this function. During Enabled, choose the Date and Time Alarm:

#### Date(of month) Alarm

You can choose which month the system will boot up. Set to 0, to boot every day.

#### Time(hh:mm:ss) Alarm

You can choose what hour, minute and second the system will boot up.

**Note:** If you have change the setting, you must let the system boot up until it goes to the operating system, before this function will work.

### IRQs Activities

Please refer to section 3-8-1.1

### 3-8-1.1 IRQs Activities

CMOS Setup Utility - Copyright(C) 1984-2004 Award Software  
 IRQs Activities

Primary INTR	ON	Item Help
IRQ3 (COM 2)	Disabled	Menu Level >>>
IRQ4 (COM 1)	Enabled	
IRQ5 (LPT 2)	Enabled	
IRQ6 (Floppy Disk)	Enabled	
IRQ7 (LPT 1)	Enabled	
IRQ8 (RTC Alarm)	Disabled	
IRQ9 (IRQ2 Redir)	Disabled	
IRQ10 (Reserved)	Disabled	
IRQ11 (Reserved)	Disabled	
IRQ12 (PS/2 Mouse)	Enabled	
IRQ13 (Coprocessor)	Enabled	
IRQ14 (Hard Disk)	Enabled	
IRQ15 (Reserved)	Disabled	
↑↓→← Move Enter:Select +/-/PU/PD:Value F10:Save ESC:Exit F1:General Help F5:Previous Values F6:Optimized Defaults F7:Standard Defaults		

### 3-9 Miscellaneous Control

This section describes configuring the PCI bus system. PCI, or Personal Computer Interconnect, is a system which allows I/O devices to operate at speeds nearing the speed the CPU itself uses when communicating with its own special components. This section covers some very technical items and it is strongly recommended that only experienced users should make any changes to the default settings.

CMOS Setup Utility - Copyright(C) 1984-2004 Award Software  
 PnP/PCI Configurations

Flash Write Protect	Enabled	Item Help
PnP OS Installed	No	Menu Level >
Resources Controlled By	Auto(ESCD)	
x IRQ Resources	Press Enter	
Assign IRQ For VGA	Enabled	
Assign IRQ For USB	Enabled	
Maximum payload size	4096	
↑↓→← Move Enter:Select +/-/PU/PD:Value F10:Save ESC:Exit F1:General Help F5:Previous Values F6:Optimized Defaults F7:Standard Defaults		

#### Reset Configuration Data

Normally, you leave this field Disabled. Select Enabled to reset Extended System Configuration Data (ESCD) when you exit Setup if you have installed a new add-on and the system reconfiguration has caused such a serious conflict that the operating system can not boot. The settings are: Enabled and Disabled.

---

---

### Resource Controlled By

The Award Plug and Play BIOS has the capacity to automatically configure all of the boot and Plug and Play compatible devices. However, this capability means absolutely nothing unless you are using a Plug and Play operating system such as Windows®95/98. If you set this field to “manual” choose specific resources by going into each of the sub menu that follows this field (a sub menu is preceded by a “>”).

The settings are: Auto(ESCD), Manual.

### IRQ Resources

When resources are controlled manually, assign each system interrupt a type, depending on the type of device using the interrupt.

Please refer to section 3-9-1

### PCI/VGA Palette Snoop

Leave this field at *Disabled*. The settings are Enabled, Disabled.

## 3-9-1 IRQ Resources

CMOS Setup Utility - Copyright(C) 1984-2004 Award Software

### IRQ Resources

			Item Help
IRQ3	assigned to	PCI Device	
IRQ4	assigned to	PCI Device	
IRQ5	assigned to	PCI Device	
IRQ7	assigned to	PCI Device	Menu Level >>
IRQ9	assigned to	PCI Device	
IRQ10	assigned to	PCI Device	
IRQ11	assigned to	PCI Device	
IRQ12	assigned to	PCI Device	
IRQ14	assigned to	PCI Device	
IRQ15	assigned to	PCI Device	

↑↓→← Move Enter:Select +/-/PU/PD:Value F10:Save ESC:Exit F1:General Help  
F5:Previous Values F6:Optimized Defaults F7:Standard Defaults

## 3-10 PC Health Status

This section shows the Status of you CPU, Fan, Warning for overall system status. This is only available if there is Hardware Monitor onboard.

CMOS Setup Utility - Copyright(C) 1984-2004 Award Software

### PC Health Status

PC N.V.R	<b>Enabled</b>	Item Help
Shutdown Temperature	<b>Disabled</b>	
Vcore	1.55V	Menu Level >
VDIMM 2.5V	2.64V	
VCC3.3V	3.03V	
+5V	5.08V	
+12V	11.96V	
3VSB	3.33V	
-12V	(-)12.36V	
5VSB	4.91V	
5VSB	3.3V	
CPU Temperature	35°C	
CPUFAN	3010 rpm	
SFAN1	0 rpm	
SFAN2	0 rpm	
↑↓→← Move Enter:Select +/-/PU/PD:Value F10:Save ESC:Exit F1:General Help F5:Previous Values F6:Optimized Defaults F7:Standard Defaults		

### Shutdown Temperature

This item can let users setting the Shutdown temperature, when CPU temperature over this setting the system will auto shutdown to protect CPU.

### Show PC Health in Post

During Enabled, it displays information list below. The choice is either Enabled or Disabled

### Current CPU Temperature/Current System Temp/Current FAN1, FAN2 Speed/Vcore/Vdd/3.3V/+5V/+12V/-12V/VBAT(V)/5VSB(V)

This will show the CPU/FAN/System voltage chart and FAN Speed.

### Detect CPUFAN in Post

During Enabled, system will warn the user if CPU Fan is not functioning.

## 3-11 Thermal Throttling Option

CMOS Setup Utility - Copyright(C) 1984-2004 Award Software

### Miscellaneous Control

CPU Thermal-Throttling	Disabled	Item Help
CPU Thermal-Throttling Temp	70	
CPU Thermal-Throttling Duty	87.50%	
Beep Alarm	Enabled	
		Menu Level >
↑↓→← Move Enter:Select +/-/PU/PD:Value F10:Save ESC:Exit F1:General Help F5:Previous Values F6:Optimized Defaults F7:Standard Defaults		

### CPU Thermal Throttling Temp

This item allows you to activate the CPU Thermal Throttling function when the CPU temperature is over the value which you set to low down the CPU temperature when at high workload to protect processor from damage or accidental shutdown.

## 3-12 Power User Overclock Settings

Phoenix - AwardBIOS CMOS Setup Utility

### Power User Overclock Settings

Current FSB Frequency	200MHZ	Item Help
Current DRAM Frequency	200MHZ	
CPU Voltage at Next Boot	Default	Menu Level >
CPU Ratio at next boot	Default	
MEM Clock at Next Boot	Auto	
CPU Clock at next Boot	200MHZ	
CPU Vcore 7-Shift	Normal(Default)	
VDIMM Select	2.55V (Default)	
NBchip 1.2V Select	1.20 (Default)	
SBChip 1.5V Select	1.50 (Default)	
↑↓→← Move Enter:Select +/-/PU/PD:Value F10:Save ESC:Exit F1:General Help F5:Previous Values F6:Optimized Defaults F7:Standard Defaults		

### CPU/DRAM Clock at next Boot is

This item allows you change the CPU Host /DRAM clock for overclock demand. *When the CPU Host clock is over the CPU default value BIOS will auto disabled Bi-Turbo function.*

### CPU Vcore 7-Shift

This item allows you select the CPU Vcore Voltage xx% more than the standard value, by this function for the precise over-clocking for extra demanding of performance.

### VDIMM Select

This item allows you to select 2.5V of the DDR Module. The choice are: 2.55V, 2.6V, 2.65V, 2.7V.

## NB Voltage

This item allows you to select value of Voltage for North Bridge Chipset.

## LDT Voltage

This item allows you to select value of Voltage for LDT.

Phoenix - AwardBIOS CMOS Setup Utility  
Power User Overclock Settings

Current FSB Frequency	PCIE Clock	Item Help
Current DRAM Frequency		
CPU Voltage at Next Boot	Min= 100	
CPU Ratio at next boot	Max= 150	Menu Level >
MEM Clock at Next Boot		
CPU Clock at next Boot		
CPU Vcore 7-Shift		
VDIMM Select		
NBchip 1.2V Select		
SBChip 1.5V Select		
↑↓←→ Move Enter:Select +/-/PU/PD:Value F10:Save ESC:Exit F1:General Help F5:Previous Values F6:Optimized Defaults F7:Standard Defaults		

Phoenix - AwardBIOS CMOS Setup Utility

Current FSB Frequency	CPU Vcore 7-Shift	Item Help
Current DRAM Frequency	Normal . . . . . [ ]	
CPU Voltage at Next Boot	+ 5% . . . . . [ ]	
CPU Ratio at next boot	+ 10% . . . . . [ ]	
MEM Clock at Next Boot	+ 15% . . . . . [ ]	Menu Level >
CPU Clock at next Boot	+ 20% . . . . . [ ]	
CPU Vcore 7-Shift	+ 25% . . . . . [ ]	
VDIMM Select	+ 30% . . . . . [ ]	
NBchip 1.2V Select	+ 35% . . . . . [ ]	
SBChip 1.5V Select		
	2.55V (Default)	
	1.20 (Default)	
	1.50 (Default)	
↑↓←→ Move Enter:Select +/-/PU/PD:Value F10:Save ESC:Exit F1:General Help F5:Previous Values F6:Optimized Defaults F7:Standard Defaults		

Phoenix - AwardBIOS CMOS Setup Utility

Current FSB Frequency	SBChip VDD Select	Item Help
Current DRAM Frequency	2.55V(Default) . . . . . [ ]	
CPU Voltage at Next Boot	2.60V . . . . . [ ]	
CPU Ratio at next boot	2.65V . . . . . [ ]	Menu Level >
MEM Clock at Next Boot	2.70V . . . . . [ ]	
CPU Clock at next Boot		
CPU Vcore 7-Shift		
VDIMM Select		
NBchip 1.2V Select		
SBChip 1.5V Select		
	Normal(Default)	
	2.55V (Default)	
	1.20 (Default)	
	1.50 (Default)	
↑↓←→ Move Enter:Select +/-/PU/PD:Value F10:Save ESC:Exit F1:General Help F5:Previous Values F6:Optimized Defaults F7:Standard Defaults		

Phoenix - AwardBIOS CMOS Setup Utility  
Power User Overclock Settings

<p>Current FSB Frequency            200MHZ          Current DRAM Frequency        200MHZ          CPU Voltage at Next Boot      Default          CPU Ratio at next boot        Default          MEM Clock at Next Boot          CPU Clock at next Boot          CPU Vcore 7-Shift          VDIMM Select          NBchip 1.2V Select          SBChip 1.5V Select</p>	<p>Item Help</p>	<p>level &gt;</p>
<div style="border: 2px solid blue; background-color: blue; color: white; padding: 5px; width: fit-content; margin: auto;"> <p><b>NB Voltage</b></p> <hr/> <p>1.50V            . . . . . [ ]</p> <p>1.60V(Default) . . . . . [ <input checked="" type="checkbox"/> ]</p> <p>1.70V            . . . . . [ ]</p> <p>1.80V            . . . . . [ ]</p> <hr/> <p>↑↓:Move   ENTER:Accept   ESC:Abort</p> </div>		
<p>↑↓→← Move Enter:Select +/-/PU/PD:Value F10:Save ESC:Exit F1:General Help          F5:Previous Values    F6:Optimized Defaults    F7:Standard Defaults</p>		

---

---

## 3-13 Password Settings

Phoenix - AwardBIOS CMOS Setup Utility

### Password Settings

Set Supervisor Password Set User Password	Press Enter Press Enter	Item Help Menu Level >
↑↓→← Move Enter:Select +/-/PU/PD:Value F10:Save ESC:Exit F1:General Help F5:Previous Values F6:Optimized Defaults F7:Standard Defaults		

You can set either supervisor or user password, or both of them. The differences are:

**Supervisor password:** Can enter and change the options of the setup menus.

**User password:** Can only enter but do not have the right to change the options of the setup menus. When you select this function, the following message will appear at the center of the screen to assist you in creating a password.

#### ENTER PASSWORD:

Type the password, up to eight characters in length, and press <Enter>. The password typed now will clear any previously entered password from CMOS memory. You will be asked to confirm the password. Type the password again and press <Enter>. You may also press <Esc> to abort the selection and not enter a password.

To disable a password, just press <Enter> when you are prompted to enter the password. A message will confirm that the password will be disabled. Once the password is disabled, the system will boot and you can enter Setup freely.

#### PASSWORD DISABLED.

When a password has been enabled, you will be prompted to enter it every time you try to enter Setup. This prevents an unauthorized person from changing any part of your system configuration. Additionally, when a password is enabled, you can also require the BIOS to request a password every time your system is rebooted. This would prevent unauthorized use of your computer.

You determine when the password is required within the BIOS Features Setup Menu and its Security option. If the Security option is set to "System", the password will be required both at boot and at entry to Setup. If set to "Setup", prompting only occurs when trying to enter Setup.

## 3-14 Load Optimized/Fail-safe Defaults

### Load Standard Defaults

When you press <Enter> on this item, you get confirmation dialog box with a message similar to:

Load Standard Defaults (Y/N)? N

Pressing <Y> loads the BIOS default values for the most stable, minimal-performance system operations.

### Load Optimized Defaults

When you press <Enter> on this item, you get a confirmation dialog box with a message similar to:

Load Optimized Defaults (Y/N)? N

Pressing <Y> loads the default values that are factory settings for optimal performance system operations.

---

---

## Chapter 4

### DRIVER & FREE PROGRAM INSTALLATION

Check your package and there is A MAGIC INSTALL CD included. This CD consists of all DRIVERS you need and some free application programs and utility programs. In addition, this CD also include an auto detect software which can tell you which hardware is installed, and which DRIVERS needed so that your system can function properly. We call this auto detect software MAGIC INSTALL.

#### MAGIC INSTALL supports WINDOWS 9X/ME/NT4.0/2000/XP

Insert CD into your CD-ROM drive and the MAGIC INSTALL Menu should appear as below. If the menu does not appear, double-click MY COMPUTER / double-click CD-ROM drive or click START / click RUN / type X:\SETUP.EXE (assuming X is your CD-ROM drive).



**From MAGIC INSTALL MENU you may make 10 selections:**

1. VIA 4 IN 1      install VIA Service Pack 4 IN 1 driver
2. VGA            install VIA P4M890 VGA Driver
3. SOUND         install ALC Audio Codec driver
4. LAN            install VIA 10/100MB LAN Controller driver
5. USB2.0        install USB 2.0 driver
6. PC-CILLIN     install PC-CILLIN2006 anti-virus program
7. PC-HEALTH    install ITE Smart Guardian Utility
8. BROWSE CD    to browse the contents of the CD
9. EXIT            to exit from MAGIC INSTALL menu

---

---

## 4-1 VIA 4 IN 1 Install VIA Service Pack 4 IN 1 Driver

\* The path of the file is X:\VIA\DRIVER\SETUP.EXE

**IDE :** VIA ATAPI VENDOR SUPPORT DRIVER IS USED TO FIXED COMPATIBILITY ISSUE FOR IDE DEVICES

**AGPVXD :** VIA AGPVXD DRIVER IS TO BE INSTALLED, IF YOU ARE USING AN AGP VGA CARD, VIAGART.VXD WILL PROVIDE SERVICE ROUTINES TO YOUR VGA DRIVER AND INTERFACE DIRECTLY TO HARDWARE, PROVIDING FAST GRAPHIC ACCESS

**IRQ ROUTING :** VIA PCI IRQ MINIPOINT DRIVER IS TO BE INSTALLED UNDER WIN98 ONLY, IT WILL FIX PCI IRQ ROUTING SEQUENCE

**INF :** VIA REGISTRY DRIVER IS TO BE INSTALLED UNDER WINDOWS THE DRIVER WILL ENABLE VIA POWER MANAGERMENT CONTROLLER



1. Click IDE when MAGIC INSTALL MENU appears



2. Click NEXT when VIA Service Pack Wizard appears

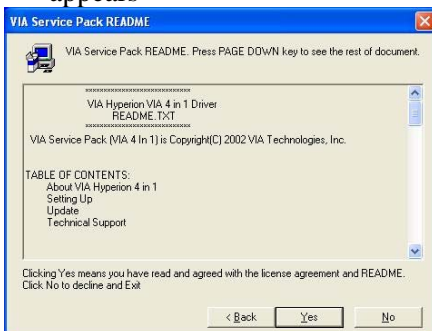

3. This is to announce the Copy Right, click Yes



4. Click NEXT to Normal Installation



5. Click NEXT to VIA INF Driver 2.30A



6. Click Finish to restart computer

---

---

## 4-2 VGA install VIA P4M890 VGA Driver

For WINDOWS 9X/ME/NT4.0/2000/XP

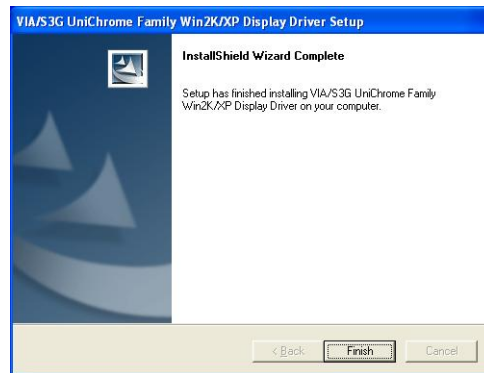

1. Click VGA when MAGIC INSTALL MENU appears
2. Click NEXT When VIA/S3G UniChrome Family Display driver setup Appears

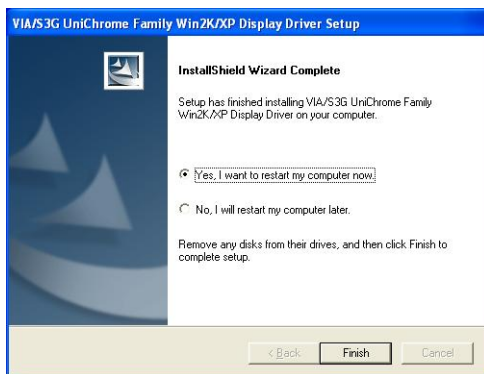

3. Click Finish to Restart Computer

## 4-3 SOUND install VIA AC97' Codec Audio Driver

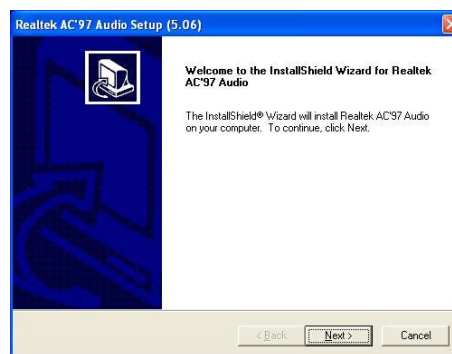

1. Click SOUND when MAGIC INSTALL MENU appears
2. Then auto detect operation system language edition, click NEXT, start to install DRIVER



3. Click Finish and Restart Windows



4. Click Start→Program→Viny Deck→Viny Deck. Then Viny Deck Windows appears

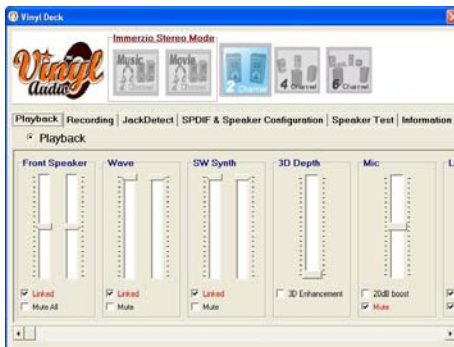

5. Speaker configuration setting



6. 2-ch Speaker position test

**Note:** The path of the file

For WIN98/NT4.0/WIN2K/XP is X:\CODEC\VIACODEC\SETUP.EXE

**Note:** In Win2K/WinME users have to click Control Panel\System\Device Manager\DVD\CD-ROM drives to Enabled digital CD Audio for the CD-ROM Device when use the SPDIF-Out digital signal.

## 4-4 LAN Install VIA LAN Controller Driver

The VIA 10/100Mb PCI Ethernet Adapter Driver path is X:\VIA\LANDRV

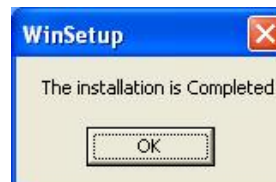

1. Click LAN when Magic Install Menu appear 2. Click OK to The installation is Completed

---

---

## 4-5 PC-HEALTH Install MyGuard Hardware monitor Utility



1. Click PC-HEALTH when MAGIC INSTALL MENU appears
2. Click Next when Install shield wizard Window appears, Choose destination location and click Next, when the start copy file windows appear, click next

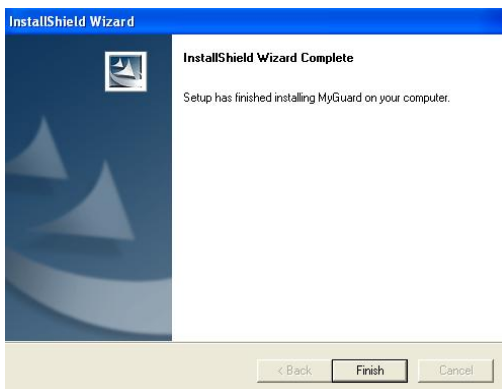

3. Select Finish after setup complete
4. Execute MY GUARD utility, On-time Monitoring your system health

### NOTE:

**MAGIC INSTALL will auto detect file path X:\NFORCE4\MYGUARD\SETUP.EXE**

## 4-6 PC-CILLIN Install PC-CILLIN 2006 Anti-virus program



1. Click PC-CILLIN when MAGIC INSTALL MENU appears

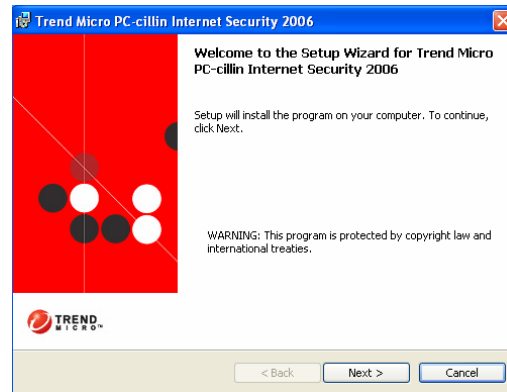

2. Please select "Install program" when the "Trend Micro internet security" installshield wizard windows appears



3. This is license agreement, select "I Accept the terms" and Click NEXT



4. Click NEXT or choose Change to change the path for the file to be stored



5. Click INSTALL, Start to install the software

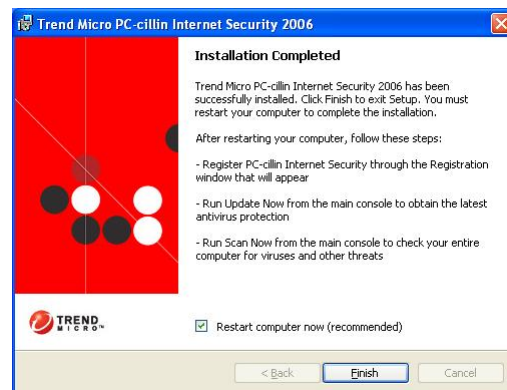

Setup Complete and click FINISH

**Note :** Please install ACROBAT READER for reading PC-CILLIN 2006 User Manual which locates at the path "X:\acrobat\adberdr6\_enu\_full.exe".

## 4-7 USB2.0 Install VIA USB2.0 DEVICE DRIVER



1. Click USB2.0 when MAGIC INSTALL MENU Appear



2. When USB2.0 Setup Program Appear, Click NEXT

**Note:** Please Install Microsoft Service Pack 1 in Windows XP OS Before you Install VIA USB2.0 Device Driver.



3. Select Install USB Driver and Click NEXT



4. Select FINISH and Restart your Computer

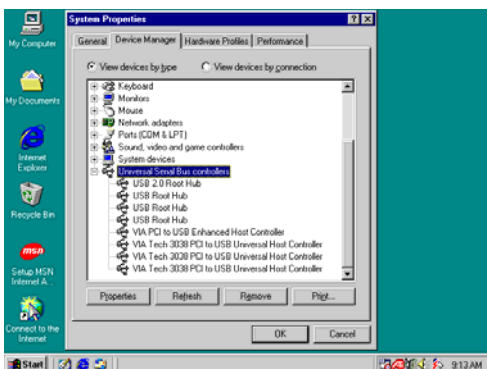

5. Check device working properly in Device Manager

The Path of the file is X:\VIA\VIAUSB20\SETUP.EXE

## 4-8 SATA Install VIA Serial ATA



1. Click SATA when MAGIC INSTALL MENU appears



2. When license agreement appear, choose I agree and click NEXT



3. Select you want to install driver



4. Review install driver and utility component, then click NEXT



5. The Following information to show installing status and Click Next



6. Click Finish and restart your computer

### Making SATA HDD driver diskette before Install WindowsXP/2000

If you only have Serial ATA HDDs on your system, before you install the Windows XP or Windows 2000, you will need to make a SATA HDD driver diskette before you start to install the Operating System.

---

---

### How to make a SATA HDD driver diskette?

STEP 1: Insert the formatted diskette in floppy drive on a system which can start OS.

STEP 2: After booting OS insert the bundle CD in your CD-ROM

STEP 3: Copy all the files from \VIA\VIASATA\DriverDisk to floppy diskette

Once you have the SATA driver diskette ready, you may start to install Windows XP or Windows 2000 on your System.

### Installation of Windows XP/ Windows 2000

For installation of Windows XP or Windows 2000, please insert Windows XP or Windows 2000 CD into the CD-ROM drive. Then remove the floppy diskette, and boot the system. At the very beginning, you will see the message at the bottom of screen, "Press F6 if you need to install a third party SCSI or RAID driver...."

At this moment, please press <F6> key and follow the instructions of Windows XP or Windows 2000 for the proper installation.

## 4-9 HOW TO DISABLE ON-BOARD SOUND

Enter BIOS SETUP choose INTEGRATE PERIPHERALS choose ON-CHIP DEVICE FUNCTION choose AC97 SOUND DEVICE

Disable on-board sound function by press PAGE DOWN KEY to Disable

## 4-10 HOW TO UPDATE BIOS

Before update BIOS please choose Disabled in "Flash Part Write Protect" item on "Miscellaneous Control" in BIOS Setup, please refer page 35

**Method 1.** In DOS Mode

**STEP 1.** Prepare a boot disc. (you may make one by click START click RUN type SYS A: click OK)

**STEP 2.** Copy utility program to your boot disc. You may copy from DRIVER CD X:\FLASH\AWDFLASH.EXE or download from our web site.

**STEP 3.** Copy latest BIOS for P4M890xxx from our web site to your boot disc.

**STEP 4.** Insert your boot disc into A:,

start the computer, type "Awdflash A:\ P4Mxxx.BIN /SN/PY/CC/R"

P4Mxxx.BIN is the file name of latest BIOS it can be P4MA3.BIN or P4MB2.BIN

SN means don't save existing BIOS data

PY means renew existing BIOS data

CC means clear existing CMOS data

R means restart computer

**STEP 5.** Push ENTER and the BIOS will be updated, computer will be restarted automatically.