

TC9237BF, TC9237BN

Σ - Δ MODULATION SYSTEM DA CONVERTER WITH BUILT-IN DIGITAL FILTER

TC9237BF, TC9237BN are a 2nd order Σ - Δ modulation system 1bit DA converter with a built-in 8 times over-sampling FIR type digital filter developed for digital audio equipment.

As the de-emphasis function has been incorporation, it is possible to configure the system for digital filtering through analogue output at a low price.

FEATURES

- Built-in 8 times over-sampling FIR type digital filter.
- Over-sampling ratio (OSR) is 192fs.
- Built-in digital de-emphasis filter.
- Simultaneous outputs to L-ch and R-ch.
- Compatible with $f_s = 32k, 44.1k, 48kHz$.
- Compatible with double speed operation.
- Characteristics of the digital filter and DA converter are as follows :

DIGITAL FILTER ($f_s = 44.1kHz$)

	DIGITAL FILTER	PASS-BAND RIPPLE	TRANSIENT BAND WIDTH	STOP-BAND SUPPRESSION
Standard operation	8fs	$\pm 0.041dB$	20k~23.5kHz	- 55dB
Double speed operation	4fs	$\pm 0.026dB$	20k~24.1kHz	- 49dB

DA CONVERTER

	OSR	NOISE DISTORTION	S/N RATIO
Standard operation	192fs	- 87dB (Typ.)	98dB (Typ.)
Double speed operation	96fs	- 87dB (Typ.)	98dB (Typ.)

- 2 Kinds of package, 28-pin flat package and 28-pin DIP shrunk package.
- It is possible to construct a system in simple structure using the filter IC (TA2009P, TA2009F) dedicated to +5V single power supply operation.

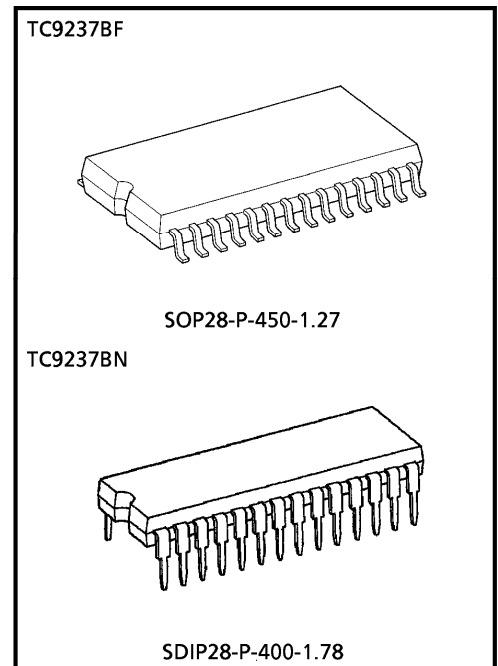

Weight
 SOP28-P-450-1.27 : 0.8g (Typ.)
 SDIP28-P-400-1.78 : 2.2g (Typ.)

980910EBA2

- TOSHIBA is continually working to improve the quality and the reliability of its products. Nevertheless, semiconductor devices in general can malfunction or fail due to their inherent electrical sensitivity and vulnerability to physical stress. It is the responsibility of the buyer, when utilizing TOSHIBA products, to observe standards of safety, and to avoid situations in which a malfunction or failure of a TOSHIBA product could cause loss of human life, bodily injury or damage to property. In developing your designs, please ensure that TOSHIBA products are used within specified operating ranges as set forth in the most recent products specifications. Also, please keep in mind the precautions and conditions set forth in the TOSHIBA Semiconductor Reliability Handbook.
- The products described in this document are subject to the foreign exchange and foreign trade laws.
- The information contained herein is presented only as a guide for the applications of our products. No responsibility is assumed by TOSHIBA CORPORATION for any infringements of intellectual property or other rights of the third parties which may result from its use. No license is granted by implication or otherwise under any intellectual property or other rights of TOSHIBA CORPORATION or others.
- The information contained herein is subject to change without notice.

PIN CONNECTION

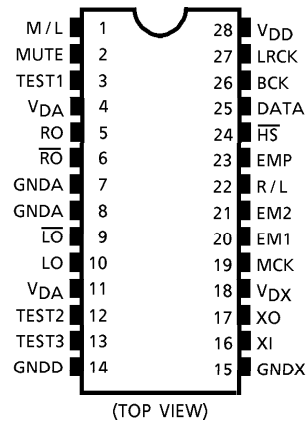

BLOCK DIAGRAM

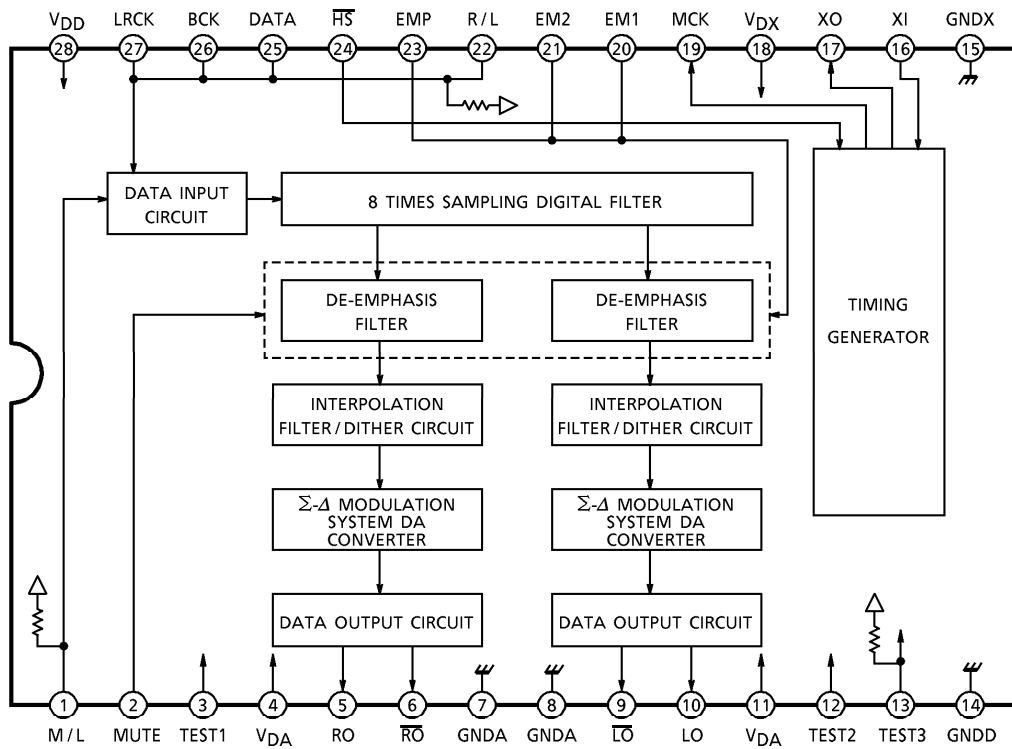

DESCRIPTION OF PIN FUNCTIONS

PIN No.	SYMBOL	I/O	FUNCTION & OPERATION	REMARKS															
1	M/L	I	Input data MSB First/LSB First selection pin. MSB First at "H" and LSB First at "L"	With a pull-up resistor															
2	MUTE	I	Soft mute control pin. Mute ON at "H".																
3	TEST1	I	TEST pin. Normally, use at "H".																
4	V _{DA}	—	Analog power supply pin.																
5	RO	O	R channel data forward output pin.																
6	R \bar{O}	O	R channel data reverse output pin.																
7	G _{ND} A	—	Analog ground pin.																
8	G _{ND} A	—	Analog ground pin.																
9	L \bar{O}	O	L channel data reverse output pin.																
10	LO	O	L channel data forward output pin.																
11	V _{DA}	—	Analog power supply pin.																
12	TEST2	I	TEST pin. Normally, use at "L".																
13	TEST3	I	TEST pin. Normally, use at "H" or open.	With a pull-up resistor															
14	G _{ND} D	—	Digital ground pin.																
15	G _{ND} X	—	Crystal oscillator ground pin.																
16	XI	I	Crystal oscillator connecting pin.																
17	XO	O	Connecting a crystal oscillator, generates clock needed for the system. (384fs)																
18	V _{DX}	—	Crystal oscillator power supply pin.																
19	MCK	O	Master clock output pin. (384fs)																
20	EM1	I	De-emphasis filter mode select pin. <table border="1" style="margin: 10px auto;"> <tr> <td>EM1</td> <td>L</td> <td>L</td> <td>H</td> <td>H</td> </tr> <tr> <td>EM2</td> <td>L</td> <td>H</td> <td>H</td> <td>L</td> </tr> <tr> <td>MODE (fs selection)</td> <td colspan="2">44.1kHz</td> <td>32kHz</td> <td>48kHz</td> </tr> </table>	EM1	L	L	H	H	EM2	L	H	H	L	MODE (fs selection)	44.1kHz		32kHz	48kHz	
EM1	L	L		H	H														
EM2	L	H		H	L														
MODE (fs selection)	44.1kHz		32kHz	48kHz															
21	EM2	I																	
22	R/L	I	LRCK polarity switching pin. <table border="1" style="margin: 10px auto;"> <tr> <td rowspan="2">R/L INPUT</td> <td colspan="2">LRCK</td> </tr> <tr> <td>L</td> <td>H</td> </tr> <tr> <td>L</td> <td>R channel data</td> <td>L channel data</td> </tr> <tr> <td>H</td> <td>L channel data</td> <td>R channel data</td> </tr> </table>	R/L INPUT	LRCK		L	H	L	R channel data	L channel data	H	L channel data	R channel data	With a pull-up resistor				
R/L INPUT	LRCK																		
	L	H																	
L	R channel data	L channel data																	
H	L channel data	R channel data																	
23	EMP	I	De-emphasis filter control pin. ON at "H" and OFF at "L".																
24	H \bar{S}	I	Standard/double speed operation mode control pin. Standard operation at "H" and double speed operation at "L".																
25	DATA	I	Data input pin.																
26	BCK	I	Bit clock input pin.																
27	LRCK	I	LR clock input pin.																
28	V _{DD}	—	Logic power supply pin.																

DESCRIPTION OF BLOCK OPERATION

1. Crystal oscillation circuit and timing generator

Clock required for internal operation can be generated when crystal and capacitors are connected as shown in Fig.1.

Further, this converter is also operable when system clock is input from the outside through XI pin (Pin 16). However, a through consideration is required in this case because noise distortion and S/N ratio of the DA converter are largely affected by qualities of wave form such as jitter, rising and falling characteristics, etc. of system clock.

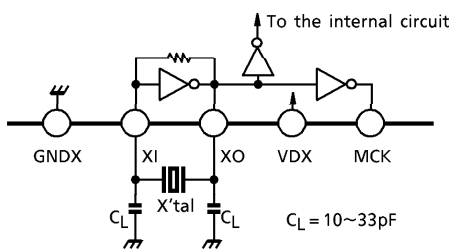

Use a crystal with a low CI value and quick response.

Fig.1 Configuration of crystal oscillation circuit

The timing generator generates clock required for the digital filter, de-emphasis filter, interpolation filter and process timing signal.

2. Data input circuit

DATA and LRCK are taken in the shift register in the LSI at the rising edge of BCK. As shown in the falling timing example, it is therefore necessary to input DATA and LRCK in synchronism with the following edge of BCK. Further, because DATA has been so designed that 16bits before the change point of LRCK are made effective data, it is necessary to data when BCK is 48fs or 64fs.

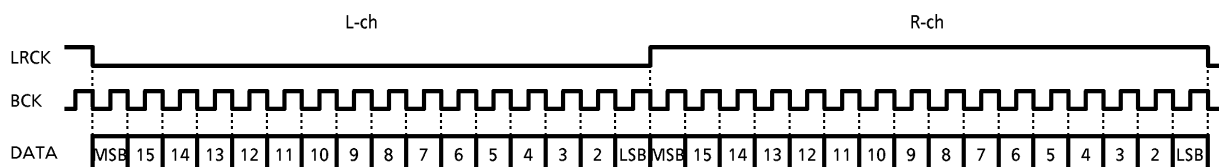

Fig.2 Example of input timing chart (When R/L = M/L = "H")

Polarity of LRCK and input data modes are set using the R/L and M/L pin.

Table.1 Channel data correspondence

R/L INPUT	LRCK	
	L	H
L	R channel data	L channel data
H	L channel data	R channel data

Table.2 Input data setting

M/L INPUT	INPUT DATA (DATA)
L	LSB data first-in
H	MSB data first-in

3. Digital filter

Foldover noise component outside the band is removed by the 8 times over-sampling FIR type digital filter. The construction and basic characteristic of the digital filter are changed by the standard and double speed operations. The contents of this change as shown below. (In the case of $f_s = 44.1\text{kHz} / 88.2\text{kHz}$ (at the double speed operation).)

- Standard operation

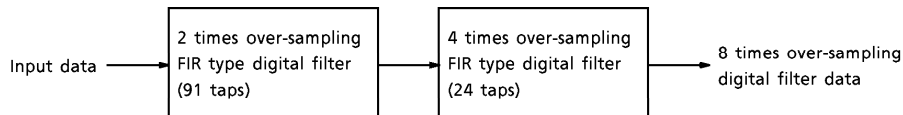

- Double speed operation

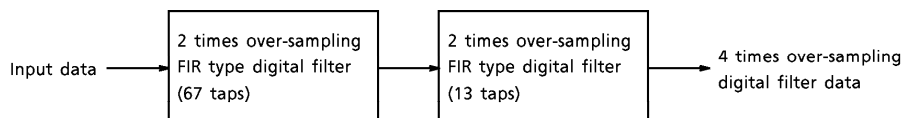

Fig.3 Construction of digital filter

Table.3 Basic characteristics of digital filter

SETTING MODE	PASS-BAND RIPPLE	TRANSIENT BANDWIDTH	STOP-BAND SUPPRESSION
Standard operation	$\pm 0.041\text{dB}$	20.0k~23.5kHz	- 55dB
Double speed operation	$\pm 0.026\text{dB}$	20.0k~24.1kHz	- 49dB

Frequency characteristics of the digital filter are as follows :

- Standard operation

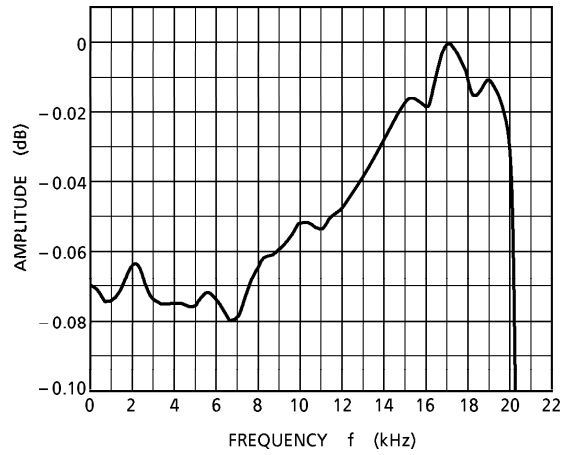
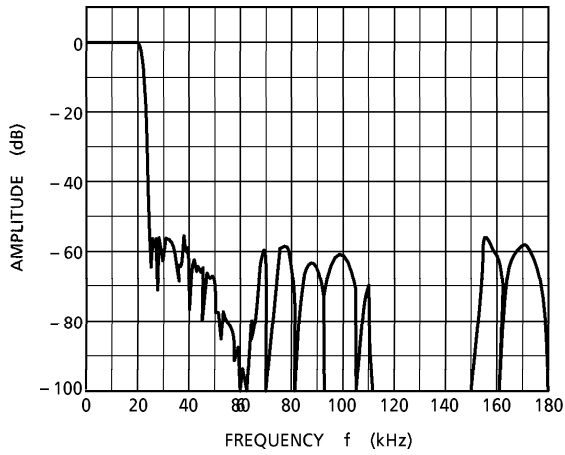

- Double speed operation

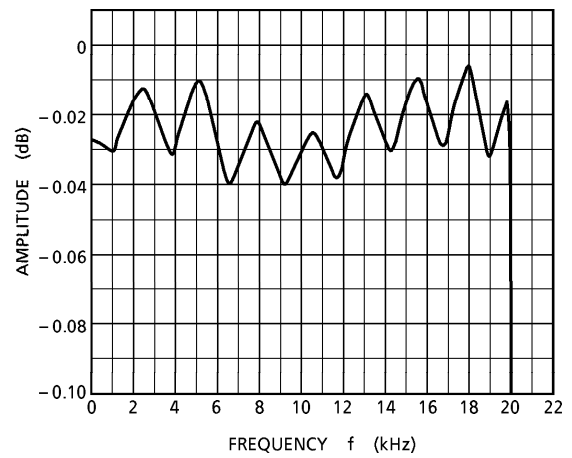
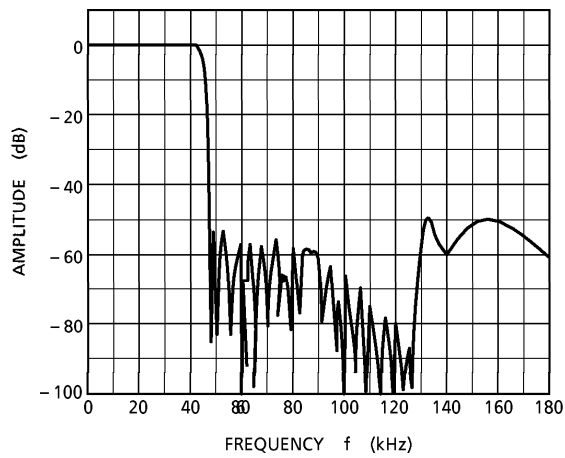

Fig.4 Digital filter frequency characteristics ($f_s = 44.1\text{kHz}$)

4. De-emphasis filter

The TC9237BF, TC9237BN has a built-in IIR type digital de-emphasis circuit and is capable of copying with 3 kinds of frequency (32kHz, 44.1kHz, 48kHz) by setting respective modes. These frequencies are set by 2 pins of EM1 and EM2 and the de-emphasis ON/OFF is switched by the EMP pin.

Table.4 fs setting of de-emphasis filter

EM1	L	L	H	H
EM2	L	H	H	L
Mode (fs selection)	44.1kHz		32kHz	48kHz

Digitization of the de-emphasis filter has eliminated the necessity for external parts such as resistor, capacitor, analogue switch, etc. Further, to reduce the characteristic error of the de-emphasis filter, coefficients have been adjusted.

The construction and characteristics of the de-emphasis filter are shown below.

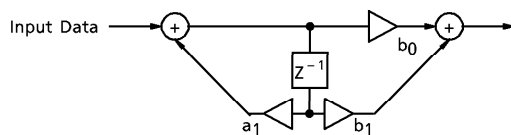

$$\text{Transfer function : } H(Z) = \frac{(b_0 + b_1 Z^{-1})}{(1 - a_1 Z^{-1})}$$

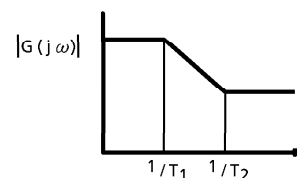

$$T_1 = 50 \mu s, T_2 = 15 \mu s$$

Fig.5 Construction of IIR type digital De-emphasis Filter

Fig.6 Filter characteristic

Table.5 Typ. example of de-emphasis frequency characteristic

● Standard operation

(Unit : dB)

SAMPLING FREQUENCY fs	f = 3kHz			f = 10kHz			MAXIMUM ERROR VALUE (ABSOLUTE VALUE)
	THEORETICAL VALUE	DESIGN VALUE	ERROR	THEORETICAL VALUE	DESIGN VALUE	ERROR	
44.1kHz	-2.426	-2.453	-0.027	-7.601	-7.626	-0.025	0.04
32kHz	-2.426	-2.291	+0.135	-7.601	-7.456	+0.145	0.19
48kHz	-2.426	-2.420	+0.006	-7.601	-7.572	+0.029	0.05

● Double speed operation :

(Unit : dB)

SAMPLING FREQUENCY fs	f = 3kHz			f = 10kHz			MAXIMUM ERROR VALUE (ABSOLUTE VALUE)
	THEORETICAL VALUE	DESIGN VALUE	ERROR	THEORETICAL VALUE	DESIGN VALUE	ERROR	
44.1kHz	-2.426	-2.348	+0.078	-7.601	-7.486	+0.115	0.12
32kHz	-2.426	-2.521	-0.095	-7.601	-7.641	-0.040	0.12
48kHz	-2.426	-2.475	-0.049	-7.601	-7.664	-0.063	0.07

5. Interpolation filter and dither circuit

The interpolation filter linearly interpolates 8fs (at the double speed operation : 4fs) after the de-emphasis filter to times and over samples to 16fs (at the double speed operation : 8fs)

Further, in the dither circuit, DC offset and dither have been added to data in order to prevent noise by the idling pattern peculiar to the Σ - Δ modulation DA converter.

After adding the dither, 192fs (at the double speed operation : 96fs) is over sampled in the sample hold circuit.

6. DA conversion circuit

The 2'nd order Σ - Δ modulation DA converter for 2 channels (Simultaneous output type) has been incorporated in the TC9237BF, TC9237BN.

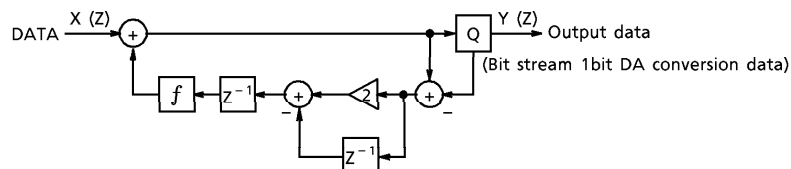

$$2'nd\ order\ \Sigma\text{-}\Delta\ modulator : Y(Z) = X(Z) + (1 - Z^{-1})^{-2}Q(Z)$$

Fig.7 Construction of Σ - Δ modulation DA converter

It was been so designed that clock for the Σ - Δ modulator is a half of master clock (MCK : Crystal oscillation clock) and the converter operates at 192fs at the standard operation while at 96fs at the double speed operation (as a clock, the same as that at the standard operation).

The noise shaping characteristic is shown below.

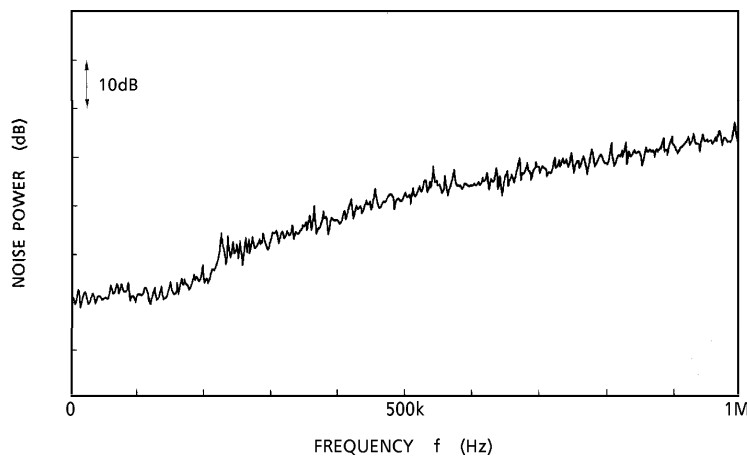

Fig.8 Noise shaping characteristic

7. Data output circuit

In this circuit, output data waveform is shaped and forward and reverse signals of bit stream data are output to the outside through a buffer.

By differentiating these forward signal and the reverse signal in the external analogue circuit, DA conversion output of low distortion factor and high S/N ratio can be obtained.

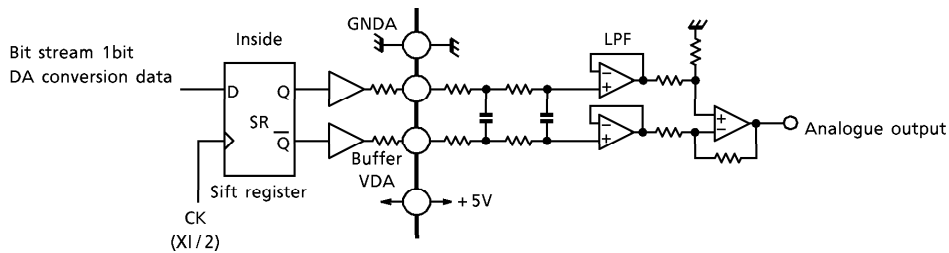

Fig.8 Construction of data output circuit

MAXIMUM RATINGS (Ta = 25°C)

CHARACTERISTIC	SYMBOL	RATING	UNIT	
Supply Voltage	V _{DD}	- 0.3~6.0	V	
	V _{DX}			
	V _{DA}			
Input Voltage	V _{in}	- 0.3~V _{DD} + 0.3	V	
Power Dissipation	TC9237BF	P _D	600	mW
	TC9237BN		800	
Operating Temperature	T _{opr}	- 35~85	°C	
Storage Temperature	T _{stg}	- 55~150	°C	

ELECTRICAL CHARACTERISTICS (Unless otherwise specified, Ta = 25°C, V_{DD} = V_{DX} = V_{DA} = 5V)

DC CHARACTERISTICS

CHARACTERISTIC	SYMBOL	TEST CIR-CUIT	TEST CONDITION	MIN.	TYP.	MAX.	UNIT
Operating Supply Voltage	V _{DD}	—	Ta = - 35~85°C	4.5	5.0	5.5	V
	V _{DX}			4.5	5.0	5.5	
	V _{DA}			4.5	5.0	5.5	
Power Dissipation	I _{DD}	—	Xl = 16.9MHz	—	25	45	mA
Input Voltage	"H" Level	—		V _{DD} × 0.7	—	V _{DD}	V
	"L" Level			0	—	V _{DD} × 0.3	
Input Current	"H" Level	—		- 10	—	10	μA
	"L" Level			I _{IH}	I _{IL}		
Pull-up Resistor	RUP	—	TEST3, M/L, R/L pins	—	130	—	kΩ

AC CHARACTERISTICS

Standard operation (Over-sampling ratio = 192fs)

CHARACTERISTIC	SYMBOL	TEST CIR-CUIT	TEST CONDITION	MIN.	TYP.	MAX.	UNIT
Noise Distortion	THD	1	1kHz sine wave, full-scale input	—	- 87	- 78	dB
S/N Ratio	S/N	1		88	98	—	dB
Dynamic Range	DR	1	1kHz sine wave, - 60dB input conversion	88	95	—	dB
Cross-Talk	CT	1	1kHz sine wave, full-scale input	—	- 95	- 88	dB
Operating Frequency	f_{opr}	—		10	16.9344	19.2	MHz
Input Frequency	f_{LR}	—	LRCK duty cycle = 50%	30	44.1	100	kHz
	f_{BCK}	—	BCK duty cycle = 50%	0.96	1.4112	6.2	MHz
Rise Time	t_r	—	LRCK, BCK (10~90%)	—	—	15	ns
Fall Time	t_f			—	—	15	
Delay Time	t_d	—	BCK \downarrow edge \rightarrow LRCK, DATA	—	—	40	ns

- Test circuit-1 : Application circuit example-2 is used.

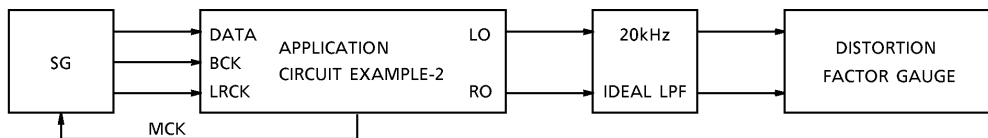

SG : ANRITSU MG-22A or equivalent

LPF : MURATA SEISAKUSHO AFL89FB20000A2 or equivalent

Distortion Factor Gauge : SIBASOKU 725B or equivalent

MEASURING ITEM	DISTORTION FACTOR GAUGE FILTER SETTING A WEIGHT
THD + N, CT	OFF
S/N, DR	ON

A weight : IEC-A or equivalent

- AC characteristic point (Input signal : LRCK, BCK, DATA)

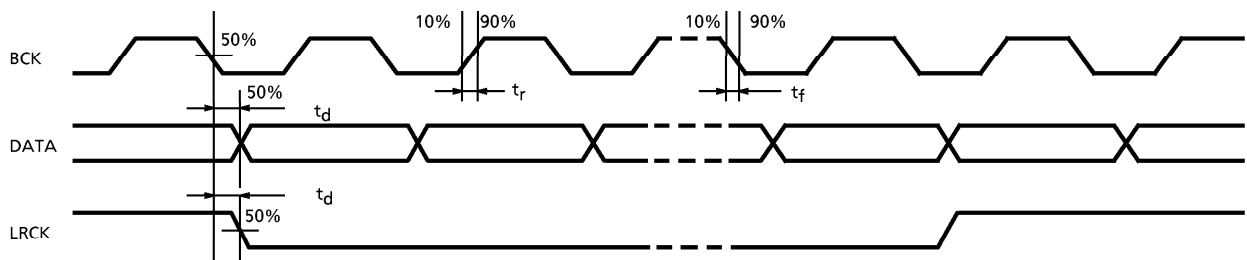

APPLICATION CIRCUIT EXAMPLE-1 (+5V single power supply used)

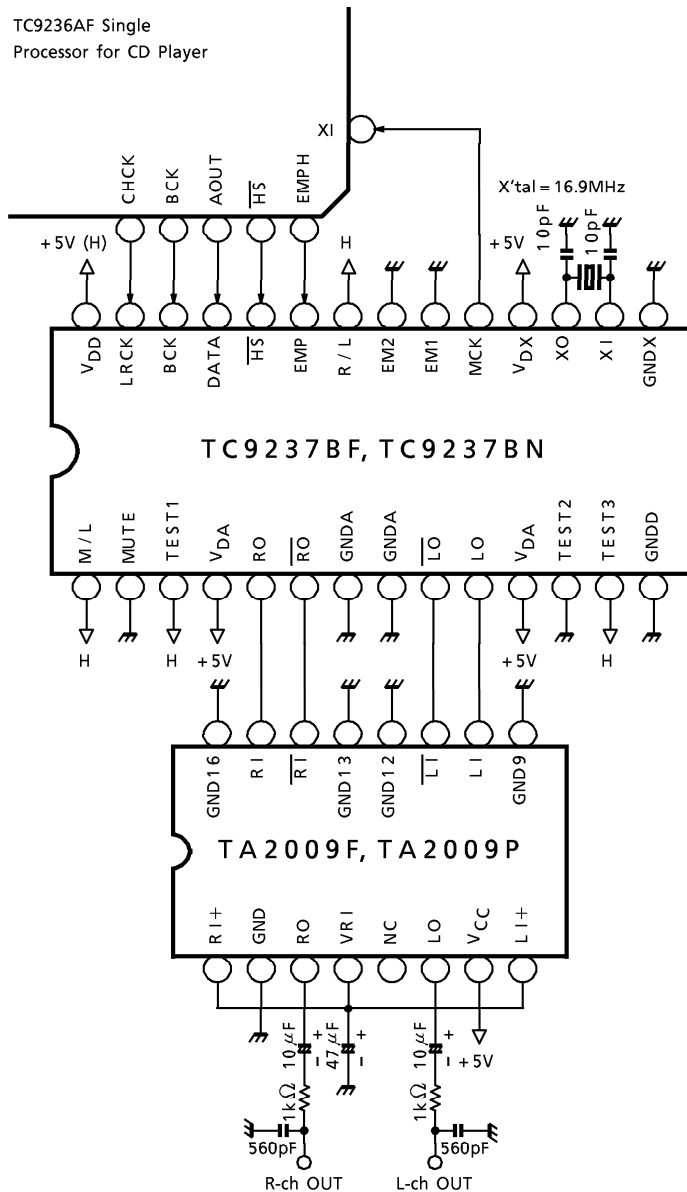

(Cautions)

- Quality of crystal oscillation waveform largely affects S/N ratio. Further, this is also true when system clock is input externally through the XI pin of Pin⑩.
- Suppress of input signals (LRCK, BCK, DATA) as could as possible.
- The wiring between the TC9237BF, TC9237BN output and the analogue filter amplifier input must be made the shortest.
- The capacitor between V_{DA} and GND_A shall be connected as close to the pin as possible.

APPLICATION CIRCUIT EXAMPLE-2 (+5V two power supply used)

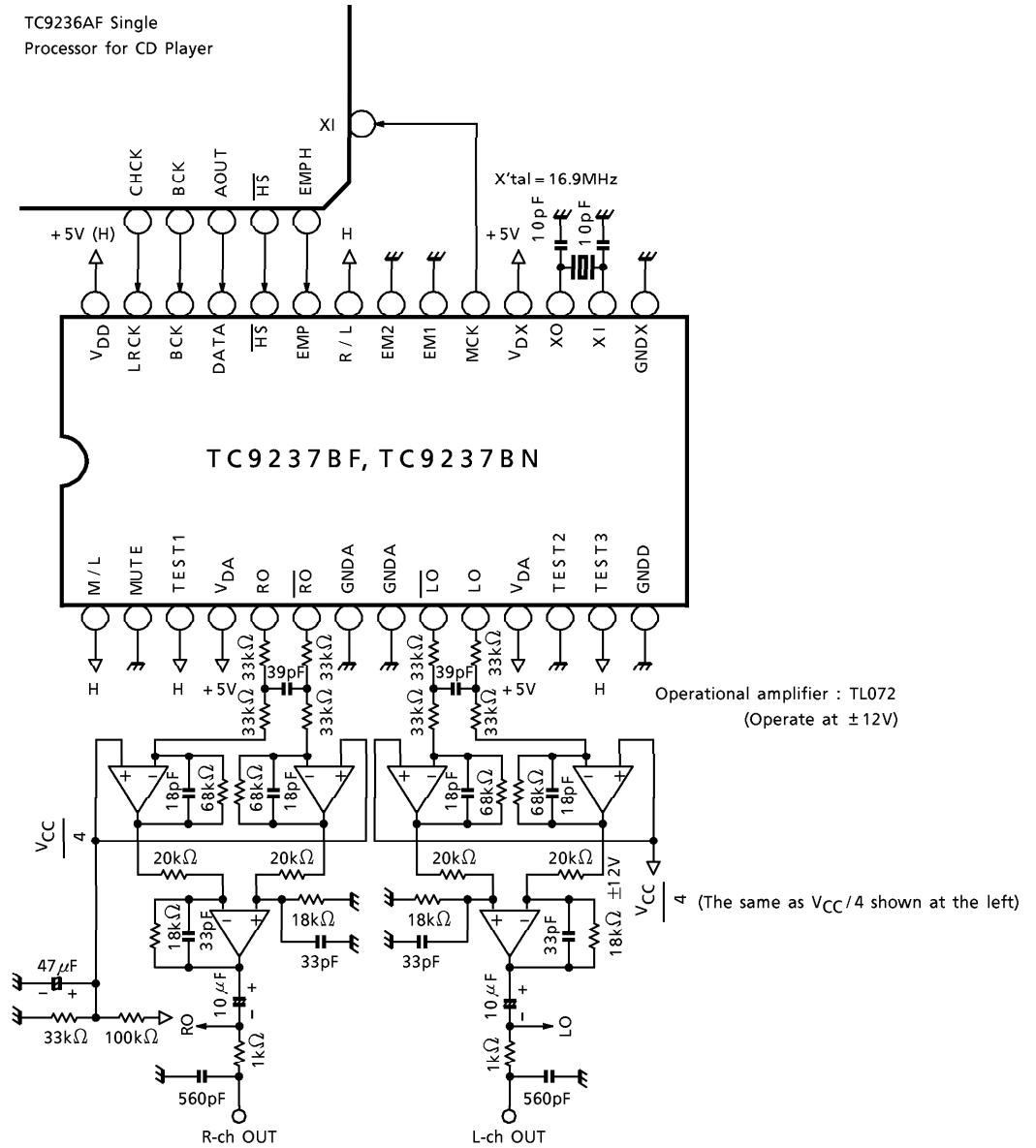

PACKAGE DIMENSIONS
SOP28-P-450-1.27

Unit : mm

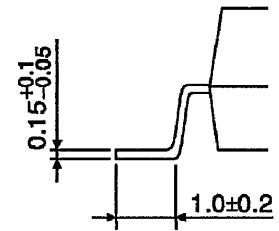
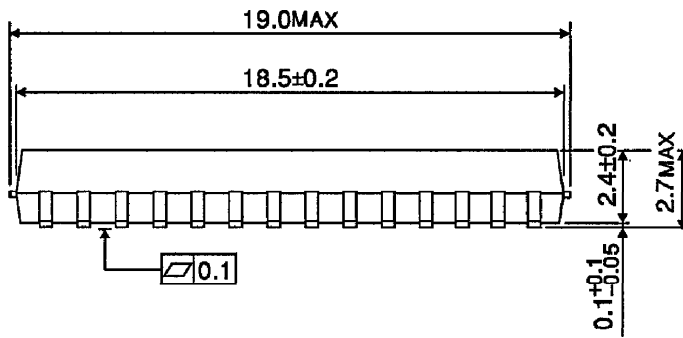
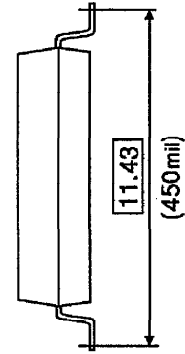
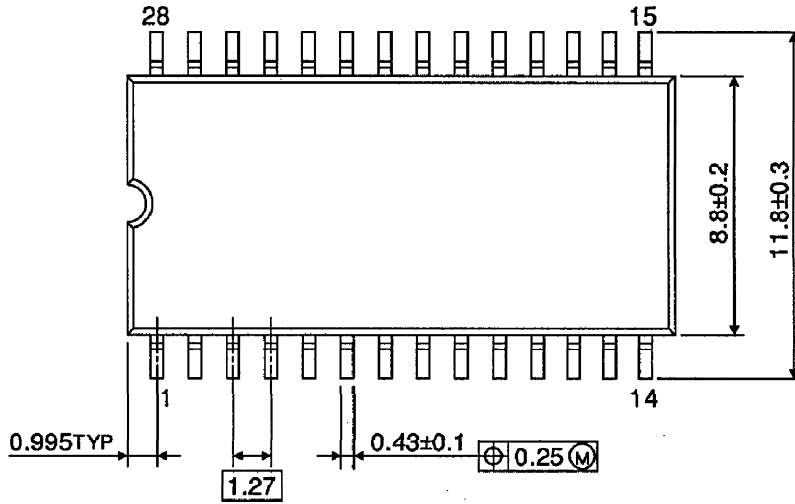

Weight : 0.8g (Typ.)

PACKAGE DIMENSIONS
SDIP28-P-400-1.78

Unit : mm

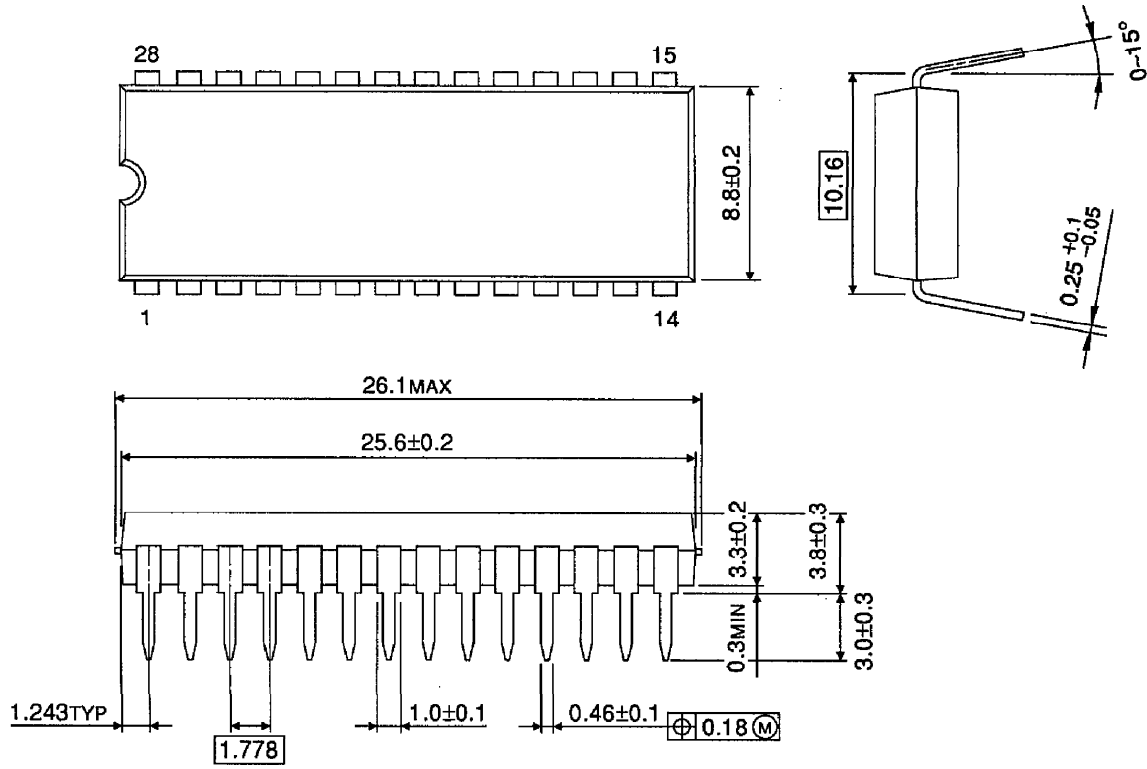

Weight : 2.2g (Typ.)