



Features

- 5 V Input Voltage
- 30 A Output Current
- 5-bit Programmable Output: 1.3 V to 3.5 V
- 93 % Efficiency
- Differential Remote Sense
- Over-Current Protection
- Over-Temperature Protection
- 27-Pin Solderable Copper Case
- 1.57 in² PCB Area ('N' Suffix)
- IPC Lead-Free 2

Description

The PT7671 Excalibur™ high performance integrated switching regulator (ISR) is rated for up to 30 A. Housed in a 27-pin, space-saving, solderable copper package, the PT7671 delivers a higher output current than many modules of similar size. This makes it an ideal choice where both a high output current and minimum board space are desirable. The PT7671 operates from a +5-V input bus and produces a tightly regulated output voltage that is programmable over the range, 1.3 V to 3.5 V. The output voltage is selected via 5-bit input code, which is compatible with VRM specifications.

The PT7671 is most suitable for powering high-end DSP, ASIC, and microprocessor circuits that require core or I/O logic supply voltages as low as 1.3 V.

Other features include output short-circuit and over-temperature protection, a standby control, and a differential remote sense to compensate for voltage drop between the regulator and load.

The PT7671 is also pin compatible with the 20-A rated PT7711.

Ordering Information

PT7671□ = 1.3 to 3.5 Volts

PT Series Suffix (PT1234 x)

Case/Pin Configuration	Order Suffix	Package Code
Vertical	N	(ENE)
Horizontal	A	(ENF)
SMD	C	(ENG)

(Reference the applicable package code drawing for the dimensions and PC board layout)

Standard Application

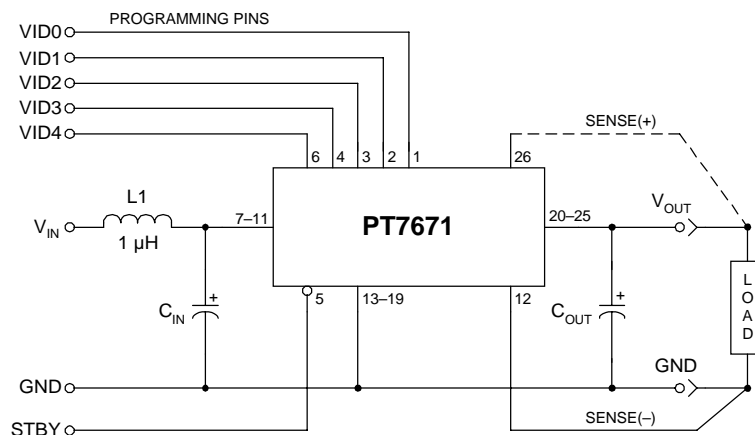

C_{in} = Required 1500 μ F electrolytic
 C_{out} = Required 330 μ F electrolytic
 L_1 = Optional 1 μ H input choke

Pin-Out Information

Pin	Function	Pin	Function
1	VID0	15	GND
2	VID1	16	GND
3	VID2	17	GND
4	VID3	18	GND
5	STBY*	19	GND
6	VID4	20	V _{out}
7	V _{in}	21	V _{out}
8	V _{in}	22	V _{out}
9	V _{in}	23	V _{out}
10	V _{in}	24	V _{out}
11	V _{in}	25	V _{out}
12	Sense(-)	26	Sense(+)
13	GND	27	Do not connect
14	GND		

* For STBY pin: open = output enabled
ground = output disabled.

Programming Information

VID3	VID2	VID1	VID0	VID4=1 V _{out}	VID4=0 V _{out}
1	1	1	1	2.00 V	1.30 V
1	1	1	0	2.10 V	1.35 V
1	1	0	1	2.20 V	1.40 V
1	1	0	0	2.30 V	1.45 V
1	0	1	1	2.40 V	1.50 V
1	0	1	0	2.50 V	1.55 V
1	0	0	1	2.60 V	1.60 V
1	0	0	0	2.70 V	1.65 V
0	1	1	1	2.80 V	1.70 V
0	1	1	0	2.90 V	1.75 V
0	1	0	1	3.00 V	1.80 V
0	1	0	0	3.10 V	1.85 V
0	0	1	1	3.20 V	1.90 V
0	0	1	0	3.30 V	1.95 V
0	0	0	1	3.40 V	2.00 V
0	0	0	0	3.50 V	2.05 V

Logic 0 = Pin 12 potential (Rem Sense Gnd)

Logic 1 = Open circuit (no pull-up resistors)

VID 3 & VID4 must not be changed while the unit is operating.

Pin Descriptions

V_{in}: The positive input voltage power node to the module, which is referenced to common GND.

GND: This is the common ground connection for the 'V_{in}' and 'V_{out}' power connections. It is also the 0 VDC reference for the 'STBY' control input.

STBY: The STBY pin is an open-collector/drain negative logic input that is referenced to GND. Applying a low-level ground signal to this input disables the module's output and places the regulator in "standby" mode. When in standby, the input current drawn by the regulator is significantly reduced. If the STBY input is left open-circuit, the module will produce an output whenever a valid input source is applied.

VID0-VID4: Selects the set-point output voltage of the regulator according to the applicable program code (See programming information). Each input, VID0 through VID4, is either connected to 'Sense(-)' or left open circuit.

V_{out}: The regulated positive power output with respect to the GND node. The set point voltage at this node is defined by the status of the pins VID0 through VID4.

Sense(+): Provides the regulator with the capability to regulate the set-point voltage at the load. When used with 'Sense(-)', the regulation circuitry will compensate for voltage drop between the converter and the load. This pin may be left open circuit, but connecting it to 'V_{out}' will improve load regulation.

Sense(-): This is the logic '0' reference for the inputs VID0 through VID4. It also provides the regulator with a differential remote sense capability when used with the 'Sense(+)' input. For optimum output voltage accuracy this pin should always be connected to GND.

Specifications (Unless otherwise stated, $T_a = 25^\circ\text{C}$, $V_{in} = 5\text{ V}$, $C_{in} = 1,500\ \mu\text{F}$, $C_{out} = 330\ \mu\text{F}$, $V_o = 3.3\text{ V}$, and $I_o = I_{o,max}$)

Characteristics	Symbols	Conditions	PT7671			Units	
			Min	Typ	Max		
Output Current	I_o	$T_a = 60^\circ\text{C}$, 200LFM, pkg N $T_a = 25^\circ\text{C}$, Natural convection	0 0	— —	30 29	A	
Input Voltage Range	V_{in}	Over I_o range	4.5	—	5.5	V	
Set-Point Voltage Tolerance	V_o tol	All output voltages	—	± 10	± 25 (1)	mV	
Temperature Variation	Reg_{temp}	$-40^\circ\text{C} \leq T_a \leq +85^\circ\text{C}$, $I_o = I_{o,min}$	—	± 1	—	% V_o	
Line Regulation	Reg_{line}	Over V_{in} range	—	± 5	—	mV	
Load Regulation	Reg_{load}	Over I_o range	—	± 5	—	mV	
Total Output Voltage Variation	ΔV_o tol	Includes set-point, line, load, $-40^\circ\text{C} \leq T_a \leq +85^\circ\text{C}$	—	± 1.5	± 2.5	% V_o	
Efficiency	η	$I_o = 15\text{ A}$	$V_o = 3.3\text{ V}$	—	93	—	%
			$V_o = 2.5\text{ V}$	—	92	—	
			$V_o = 1.8\text{ V}$	—	89	—	
		$I_o = 30\text{ A}$	$V_o = 3.3\text{ V}$	—	90	—	%
$V_o = 2.5\text{ V}$	—	87	—				
$V_o = 1.8\text{ V}$	—	83	—				
V_o Ripple (pk-pk)	V_r	20 MHz bandwidth	—	40	—	mV _{pp}	
Transient Response	t_{tr}	1 A/ μs load step, 50 % and 100 % $I_{o,max}$	—	25	—	μSec	
	V_{os}	V_o over/undershoot	—	± 200 (2)	—	mV	
Over-Current Threshold	I_{TRIP}	Reset followed by auto-recovery	—	38	—	A	
Switching Frequency	f_s	Over V_{in} range	250	300	350	kHz	
STBY* Input Requirements							
Input High Voltage	V_{IH}	Referenced to GND	2.0	—	Open (3)	V	
Input Low Voltage	V_{IL}		-0.2	—	0.8		
Input Low Current	I_{IL}	Pin 5 to GND	—	-0.3	—	mA	
Standby Input Current	$I_{in, standby}$	Pin 5 to GND	—	6	—	mA	
External Capacitance	C_{out}		330 (4)	—	15,000	μF	
Operating Temperature Range	T_a	Over V_{in} Range	-40	—	85 (5)	$^\circ\text{C}$	
Solder Reflow Temperature	T_{reflow}	Surface temperature of module pins or case	—	—	215 (6)	$^\circ\text{C}$	
Storage Temperature	T_s	—	-40	—	125	$^\circ\text{C}$	
Reliability	MTBF	Per Bellcore TR-332 50 % stress, $T_a = 40^\circ\text{C}$, ground benign	3.4	—	—	10 ⁶ Hrs	
Mechanical Shock	—	Per Mil-STD-883D, Method 2002.3 1 msec, Half Sine, mounted to a fixture	—	500	—	G's	
Mechanical Vibration	—	Mil-STD-883D, Method 2007.2 20-2000 Hz	Suffixes A, N Suffix C	—	20 (7) 20 (7)	G's	
Weight	—	Vertical/Horizontal	—	36	—	grams	
Flammability	—	Materials meet UL 94V-0	—	—	—	—	

Notes: (1) If the remote sense ground is not used, pin 12 must be connected to pin 13 for optimum output voltage accuracy.

(2) The transient response may be improved by placing additional capacitors with low equivalent series resistance (ESR) on the output.

(3) The STBY* control (pin 5) has an internal pull-up. If it is left open-circuit, the module will operate when input power is applied. A low-leakage (<1 μA) MOSFET must be used to control this pin. The open-circuit voltage may be as high as V_{in} .

(4) For operation below 0°C , C_{in} and C_{out} must have stable characteristics. Use either low ESR tantalum or Oscon® capacitors.

(5) See safe Operating Area curves or consult factory for the appropriate derating.

(6) During reflow of SMD package version do not elevate the module case, pins, or internal component temperatures above a peak of 215°C . For further guidance refer to the application note, "Reflow Soldering Requirements for Plug-in Power Surface Products," (SLIA051).

(7) The case pins on the through-hole package types (suffixes N & A) must be soldered. For more information see the applicable package outline drawing.

External Capacitors: The regulator require a minimum output capacitance of $330\ \mu\text{F}$ for proper operation. An input capacitance of $1500\ \mu\text{F}$ is also required. This must be rated for a minimum of 1.1 Arms of ripple current. For transient or dynamic load applications, additional capacitance may be required. For further information refer to the application note regarding capacitor selection for this product.

Input Filter: An input filter inductor is optional for most applications. The inductor must be sized to handle 30 ADC with a typical value of $1\ \mu\text{H}$.

Performance Characteristics, $V_{IN} = 5\text{ V}$ (See Note A)

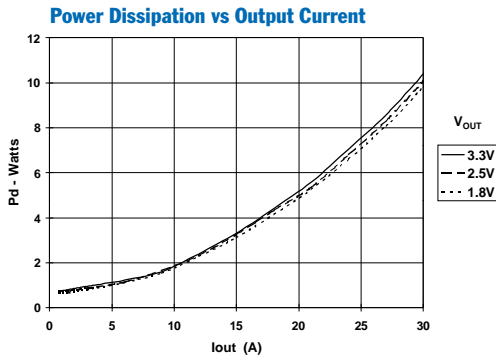
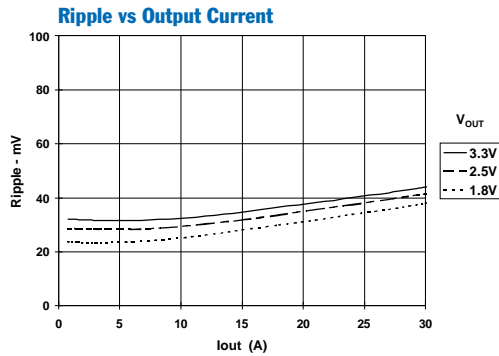
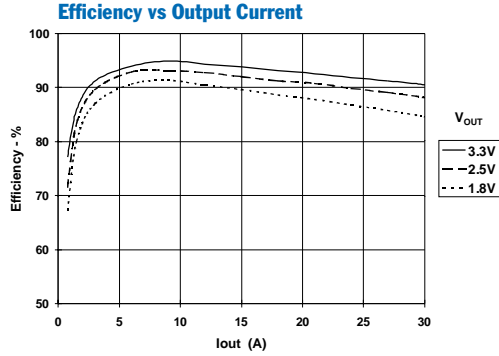

Safe Operating Area Curves (See Note B)

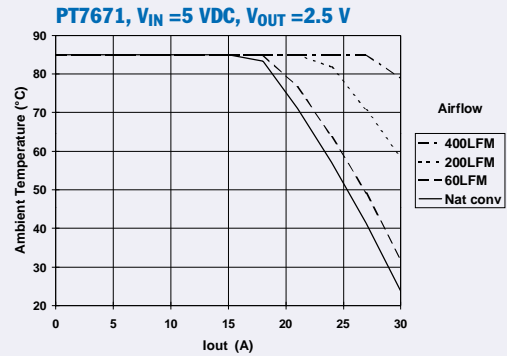
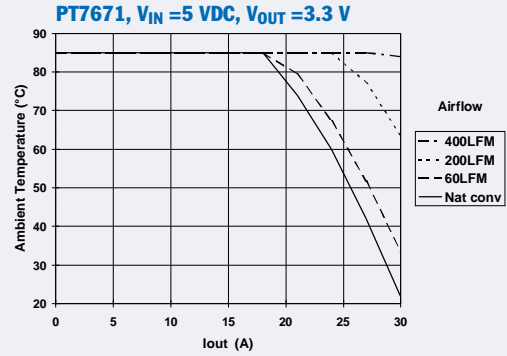

Note A: All characteristic data in the above graphs has been developed from actual products tested at 25 $^{\circ}\text{C}$. This data is considered typical for the ISR.
Note B: SOA curves represent operating conditions at which internal components are at or below manufacturer's maximum rated operating temperatures.

Operating Features and System Considerations for the PT7670 Series of ISRs

Power up & Soft-Start Timing

Following either the application of a valid input source voltage, or the removal of a ground signal to the *STBY* control pin (with input power applied), the regulator will initiate a soft-start power up. The soft start slows the rate at which the output voltage rises, and also introduces a short time delay of approx. 10ms. Figure 1-1 shows the power-up characteristic of a PT7671 with a 15-A load, and with the output voltage programmed to 3.3 V.

Figure 1-1

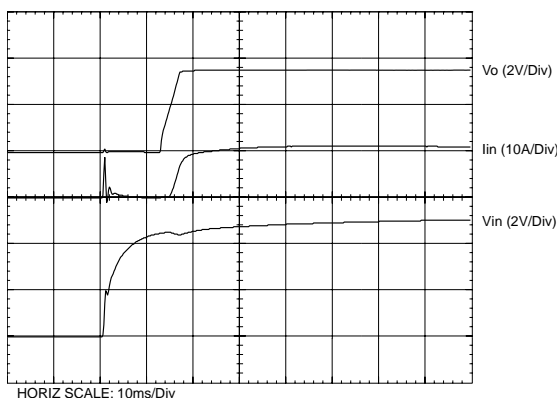

Over-Current Protection

To protect against load faults, the PT7670 series of regulators incorporates output over-current protection. Applying a load that exceeds the regulator's over-current threshold (see data sheet specifications) will cause the regulated output to shut down. Following shutdown the ISR will periodically attempt to recover by initiating a soft-start power-up. This is often described as a "hiccup" mode of operation, whereby the module continues in the cycle of successive shutdown and power up until the load fault is removed. During this period, the average current flowing into the fault is significantly reduced. Once the fault is removed, the converter automatically recovers and returns to normal operation.

Differential Remote Sense

Connecting the Sense(+) and Sense(-) pins to the load circuit allows the regulator to compensate for limited amounts of 'IR' voltage drop. This voltage drop is caused by current flowing through the trace resistance between the power converter and the 'point of regulation' some distance away. Although not recommended, leaving the

sense pins disconnected will not damage the regulator. An internal 15 Ω resistor, connected between each sense pin and its corresponding output node, keeps the output voltage in regulation. If the remote sense feature is not used it is important to at least connect the Sense(-) pin to GND locally, as this provides a return path for the regulator's internal bias currents.

With the sense leads connected, the difference between the voltage measured between the V_{out} and GND pins, and that measured between the Sense(+) and Sense(-) pins, is the amount of IR drop being compensated by the regulator. This should be limited to 0.6 V. (0.3 V maximum between pins 25 & 26, and also between pins 12 & 13).

Note: The remote sense feature is not designed to compensate for the forward drop of non-linear or frequency dependent components that may be placed in series with the converter output. Examples include OR-ing diodes, filter inductors, ferrite beads, and fuses. When these components are enclosed by the remote sense connections they are effectively placed inside the regulation control loop, which can adversely affect the stability of the regulator.

Over-Temperature Protection

The PT7670 series of ISRs incorporates an on-board temperature sensor, which protects the module's internal circuitry against excessively high temperatures. A rise in the temperature of the internal components may be the result of a drop in airflow, or a high ambient temperature. If the module's internal temperature exceeds its OTP threshold (see data sheet specifications), the regulator output is disabled and the output voltage is reduced to zero. The recovery is automatic, and begins with a soft-start power up. It occurs when the the sensed temperature decreases by about 10 $^{\circ}\text{C}$ below the trip point.

Note: The over-temperature protection is a last resort mechanism to prevent thermal stress to the regulator. Operation at or close to the thermal shutdown temperature is not recommended and will reduce the long-term reliability of the module. Always operate the regulator within the specified Safe Operating Area (SOA) limits for the worst-case conditions of ambient temperature and airflow.

Capacitor Recommendations for the PT7670 Series of 30-A Switching Regulators

Input Capacitor:

The recommended input capacitor is determined by a minimum of 1,500 μF of capacitance with a ripple current rating of 1.1 Arms.

Ripple current and $<100\text{ m}\Omega$ equivalent series resistance (ESR) values are the major considerations, along with temperature, when designing with different types of capacitors. Tantalum capacitors have a recommended minimum voltage rating of twice $2 \times$ (the maximum DC voltage + AC ripple). This is necessary to insure reliability for input voltage bus applications.

Output Capacitors:

The ESR of the required capacitors is less than 100 m Ω . Electrolytic capacitors have marginal ripple performance at frequencies greater than 400 kHz but excellent low frequency transient response. Above the ripple frequency, ceramic capacitors are necessary to improve the transient response and reduce any high frequency noise components apparent during higher current excursions. Preferred low ESR type capacitor part numbers are identified in Table 2-1.

Tantalum Capacitors(Optional Output Capacitors)

Tantalum type capacitors can be used for the output but only the AVX TPS, Sprague 593D/594/595, or Kemet T495/T510 series. These capacitors are recommended over many other tantalum types due to their higher rated surge, power dissipation, and ripple current capability. As a caution the TAJ series by AVX is not recommended. This series has considerably higher ESR, reduced power dissipation, and lower ripple current capability. The TAJ series is also less reliable than the AVX TPS series when determining power dissipation capability. Tantalum or Oscon® types are recommended for applications where ambient temperatures fall below 0 °C.

Capacitor Table

Table 2-1 identifies the characteristics of capacitors from a number of vendors with acceptable ESR and ripple current (rms) ratings. The number of capacitors required at both the input and output buses is identified for each capacitor type.

This is not an extensive capacitor list. Capacitors from other vendors are available with comparable specifications. Those listed are for guidance. The RMS ripple current rating and ESR (at 100 kHz) are critical parameters necessary to insure both optimum regulator performance and long capacitor life.

Table 2-1: Input/Output Capacitors

Capacitor Vendor/ Series	Capacitor Characteristics					Quantity		Vendor Number
	Working Voltage	Value(μF)	(ESR) Equivalent Series Resistance	Maximum Ripple Current @105 °C (Irms)	Physical Size (mm)	Input Bus	Output Bus	
Panasonic FK (SMT)	25 V	2200	0.038 Ω	1800 mA	16x16.5	1	1	EEVFK1E222M EEVFK1V331P
	35 V	330	0.080 Ω	850 mA	10x10.2	—	1	
FC (Radial)	16 V	470	0.090 Ω	755 mA	10x12.5	—	1	EEUFC1C471 EEUFC1C152S
	16 V	1500	0.043 Ω	1690 mA	16x15	1	1	
United Chemi -Con LXZ	25 V	330	0.090 Ω	760 mA	10x12.5	—	1	LXZ25VB331M10X12LL LXZ16VB152M12X20LL
	16 V	1500	0.038 Ω	1660 mA	12.5x20	1	1	
FX	10 V	680	0.015 Ω	4735 mA	10x10.5	2	1	10FX680M
Nichicon PL Series	25 V	390	0.080 Ω	720 mA	12.5x15	—	1	UPL1E391MHH6 UPL1A152MHH6
	10 V	1500	0.050 Ω	1330 mA	16x15	1	1	
NX (SMT)	10 V	330	0.024 Ω	3770 mA	10x8	5	1	PNX1A331MCR1GS
Os-con SP (Radial) SVP (SMT)	10 V	470	0.015 Ω	>4510 mA	10x10.5	3	1	10SP470M 10SVP330M
	10 V	330	0.017 Ω	>3950 mA	9x12x8.3	4	1	
AVX Tantalum TPS- Series	10 V	330	0.10 Ω	1414 mA	7.3Lx4.3W x4.1H	5	1	TPSV337M010R0100 TPSV337M010R0060
	10 V	330	0.06 Ω	1826 mA		5	1	
Sprague Tantalum 595D/594D	10 V	330	0.045±4 =0.011 Ω	>4500 mA	7.3Lx5.7W x4.0H	5	1	594D337X0010R2T 595D687X0010R2T
	10 V	680	0.09 Ω	>1510 mA		2	1	
Kemet Tantalum T510/T495 (SMT)	10 V	330	0.035 Ω	2000 mA	4.3Wx7.3L x4.0H	5	1	510X337M010AS T495X227M010AS
	10 V	220	0.07±2 =0.035 Ω	>2000 mA		6	2	
Sanyo Poscap TPB (SMT)	10 V	220	0.04 Ω	3000 mA	7.2L x4.3W x3.1H	6	2	10TPB220M

Using the Standby Function on the PT7670 Series of 30-A Switching Regulators

For applications requiring On/Off control of the output voltage, the 30-A rated PT7670 series of Excalibur ISRs incorporate an on/off “Standby” function. This feature may be used for power-up/shutdown sequencing, or to change the output voltage while input power is applied. *See related notes:* “Pin-Coded Output Voltage Adjustment of the PT7670 Series of 30-A ISRs.”

The standby function is provided by the *STBY** control, pin 5. If pin 5 is left open-circuit the regulator operates normally, providing a regulated output whenever a valid supply voltage is applied to V_{in} (pins 7-11) with respect to GND (pins 13-19). Connecting pin 5 to ground¹ will disable the regulator output². This places the regulator in standby mode, and reduces the input current to typically 6mA. If a ground signal is applied to pin 5 prior to power-up, the regulator output will remain inactive during the period that input power is applied.

The standby input must be controlled with an open-collector (or open-drain) discrete transistor (See Figure 3-1). Table 3-1 gives the input requirements.

Table 3-1 Standby Control Input Requirements

Parameter	Min	Typ	Max
Enable	2 V		Open Cct. 1
Disable	-0.2 V		0.8 V
$I_{stby} (low)$			0.5 mA
$V_{stby} (o/c)$		V_{in}	

Notes:

1. The Standby input of the PT7670 series of regulators should be controlled using an open-collector (or open-drain) discrete transistor. *Do Not* use a pull-up resistor. The control input has an open-circuit voltage equal to V_{in} . To set the regulator output to zero, the control pin must be “pulled” to less than 0.8Vdc with a 0.5mA sink to ground.

Figure 3-1

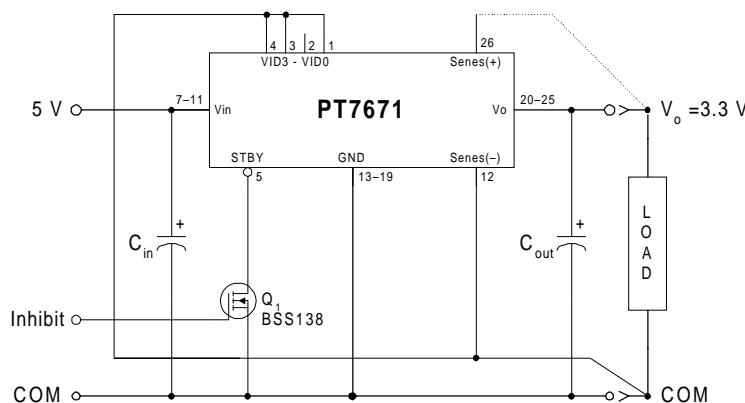

2. In the standby mode the output of the regulator is tri-state, and the output voltage falls at the rate that the load circuit discharges the output filter capacitors.
3. When the ground signal to the *Standby* pin is removed, the regulator output initiates a soft-start cycle by first asserting a low impedance to ground. If an external voltage is applied to the output bus, it will sink current and possibly over-stress the part.
4. The turn-off time of Q_1 , or rise time of the standby input is not critical. Turning Q_1 off slowly will not affect regulator operation. However, a slow turn-off time will increase both the initial delay and rise-time of the output voltage.

Turn-On Time: Turning Q_1 in Fig. 3-1 off, removes the low-voltage signal at pin 5 and enables the output³. After a delay of less than 5 ms, the output voltage rises to full regulation within 30 ms⁴. Fig. 3-2 shows the typical output voltage waveform of a PT7671 following the turn-off of Q_1 at time $t=0$ secs. In the circuit of Fig. 3-1, the output voltage is set to 3.3 V. The waveform was measured with a +5-V input source voltage, and 15-A output load.

Figure 3-2

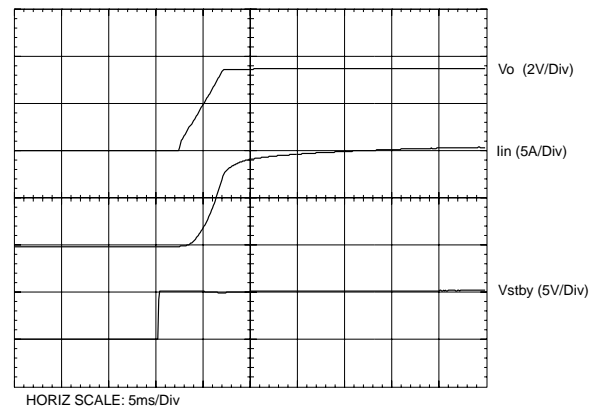

IMPORTANT NOTICE

Texas Instruments Incorporated and its subsidiaries (TI) reserve the right to make corrections, modifications, enhancements, improvements, and other changes to its products and services at any time and to discontinue any product or service without notice. Customers should obtain the latest relevant information before placing orders and should verify that such information is current and complete. All products are sold subject to TI's terms and conditions of sale supplied at the time of order acknowledgment.

TI warrants performance of its hardware products to the specifications applicable at the time of sale in accordance with TI's standard warranty. Testing and other quality control techniques are used to the extent TI deems necessary to support this warranty. Except where mandated by government requirements, testing of all parameters of each product is not necessarily performed.

TI assumes no liability for applications assistance or customer product design. Customers are responsible for their products and applications using TI components. To minimize the risks associated with customer products and applications, customers should provide adequate design and operating safeguards.

TI does not warrant or represent that any license, either express or implied, is granted under any TI patent right, copyright, mask work right, or other TI intellectual property right relating to any combination, machine, or process in which TI products or services are used. Information published by TI regarding third-party products or services does not constitute a license from TI to use such products or services or a warranty or endorsement thereof. Use of such information may require a license from a third party under the patents or other intellectual property of the third party, or a license from TI under the patents or other intellectual property of TI.

Reproduction of TI information in TI data books or data sheets is permissible only if reproduction is without alteration and is accompanied by all associated warranties, conditions, limitations, and notices. Reproduction of this information with alteration is an unfair and deceptive business practice. TI is not responsible or liable for such altered documentation. Information of third parties may be subject to additional restrictions.

Resale of TI products or services with statements different from or beyond the parameters stated by TI for that product or service voids all express and any implied warranties for the associated TI product or service and is an unfair and deceptive business practice. TI is not responsible or liable for any such statements.

TI products are not authorized for use in safety-critical applications (such as life support) where a failure of the TI product would reasonably be expected to cause severe personal injury or death, unless officers of the parties have executed an agreement specifically governing such use. Buyers represent that they have all necessary expertise in the safety and regulatory ramifications of their applications, and acknowledge and agree that they are solely responsible for all legal, regulatory and safety-related requirements concerning their products and any use of TI products in such safety-critical applications, notwithstanding any applications-related information or support that may be provided by TI. Further, Buyers must fully indemnify TI and its representatives against any damages arising out of the use of TI products in such safety-critical applications.

TI products are neither designed nor intended for use in military/aerospace applications or environments unless the TI products are specifically designated by TI as military-grade or "enhanced plastic." Only products designated by TI as military-grade meet military specifications. Buyers acknowledge and agree that any such use of TI products which TI has not designated as military-grade is solely at the Buyer's risk, and that they are solely responsible for compliance with all legal and regulatory requirements in connection with such use.

TI products are neither designed nor intended for use in automotive applications or environments unless the specific TI products are designated by TI as compliant with ISO/TS 16949 requirements. Buyers acknowledge and agree that, if they use any non-designated products in automotive applications, TI will not be responsible for any failure to meet such requirements.

Following are URLs where you can obtain information on other Texas Instruments products and application solutions:

Products

Audio	www.ti.com/audio
Amplifiers	amplifier.ti.com
Data Converters	dataconverter.ti.com
DLP® Products	www.dlp.com
DSP	dsp.ti.com
Clocks and Timers	www.ti.com/clocks
Interface	interface.ti.com
Logic	logic.ti.com
Power Mgmt	power.ti.com
Microcontrollers	microcontroller.ti.com
RFID	www.ti-rfid.com
RF/IF and ZigBee® Solutions	www.ti.com/lprf

Applications

Communications and Telecom	www.ti.com/communications
Computers and Peripherals	www.ti.com/computers
Consumer Electronics	www.ti.com/consumer-apps
Energy and Lighting	www.ti.com/energy
Industrial	www.ti.com/industrial
Medical	www.ti.com/medical
Security	www.ti.com/security
Space, Avionics and Defense	www.ti.com/space-avionics-defense
Transportation and Automotive	www.ti.com/automotive
Video and Imaging	www.ti.com/video
Wireless	www.ti.com/wireless-apps

TI E2E Community Home Page

e2e.ti.com

Mailing Address: Texas Instruments, Post Office Box 655303, Dallas, Texas 75265
Copyright © 2011, Texas Instruments Incorporated