

PQxxxEZ5MZ Series/PQxxxEZ01Z Series

SC-63 Package, Low Voltage Operation Low Power-Loss Voltage Regulators

■ Features

- Low voltage operation (Minimum operating voltage: 2.35V)
2.5V input → available 1.5 to 1.8V
- Low dissipation current
Dissipation current at no load : MAX. 2mA
Output OFF-state dissipation current: MAX. 5μA
- Built-in overcurrent protection and overheat protection functions

■ Applications

- Peripheral equipment of personal computers
- Power supplies for various electronic equipment such as DVD player or STB

■ Model Line-up

Output current (I _O)	Package type	Output voltage (V _O)		
		1.5V	1.8V	2.5V
0.5A	Taping	PQ015EZ5MZP	PQ018EZ5MZP	PQ025EZ5MZP
	Sleeve	PQ015EZ5MZZ	PQ018EZ5MZZ	PQ025EZ5MZZ
1A	Taping	PQ015EZ01ZP	PQ018EZ01ZP	PQ025EZ01ZP
	Sleeve	PQ015EZ01ZZ	PQ018EZ01ZZ	PQ025EZ01ZZ
		3V	3.3V	
0.5A	Taping	PQ030EZ5MZP	PQ033EZ5MZP	
	Sleeve	PQ030EZ5MZZ	PQ033EZ5MZZ	
1A	Taping	PQ030EZ01ZP	PQ033EZ01ZP	
	Sleeve	PQ030EZ01ZZ	PQ033EZ01ZZ	

■ Absolute Maximum Ratings

(T_a=25°C)

Parameter	Symbol	Rating	Unit
Input voltage	V _{IN}	10	V
*1 ON/OFF control terminal voltage	V _C	10	V
Output current	I _O	0.5	A
		1	
*2 Power dissipation	P _D	8	W
*3 Junction temperature	T _J	150	°C
Operating temperature	T _{opr}	-40 to +85	°C
Storage temperature	T _{stg}	-40 to +150	°C
Soldering temperature	T _{sol}	260 (10s)	°C

*1 All are open except GND and applicable terminals.

*2 P_D: With infinite heat sink

*3 Overheat protection may operate at T_J=125°C to 150°C

■ Outline Dimensions

(Unit : mm)

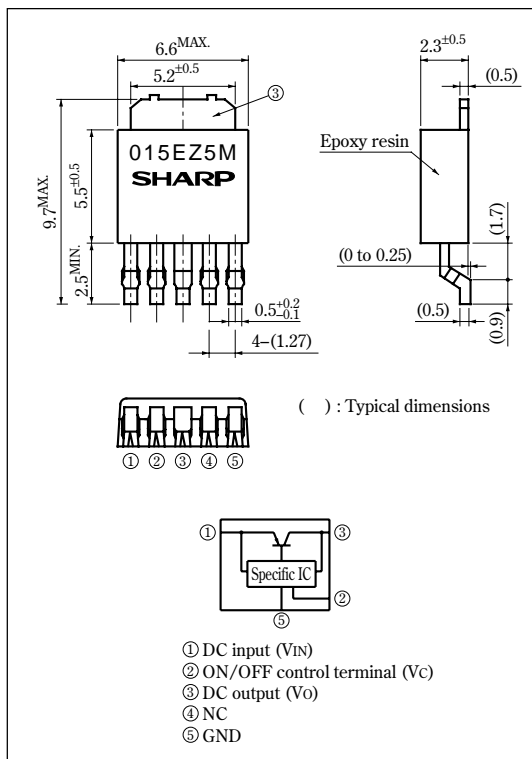

•Please refer to the chapter " Handling Precautions ".

SHARP

Notice In the absence of confirmation by device specification sheets, SHARP takes no responsibility for any defects that may occur in equipment using any SHARP devices shown in catalogs, data books, etc. Contact SHARP in order to obtain the latest device specification sheets before using any SHARP device.
Internet Internet address for Electronic Components Group <http://sharp-world.com/ecg/>

Electrical Characteristics

(Unless otherwise specified, condition shall be $V_{IN}=V_O(TYP.)+1V$, $I_O=0.3A$, $V_C=2.7V$, $T_a=25^\circ C$ (PQxxxEZ5MZ))

(Unless otherwise specified, condition shall be $V_{IN}=V_O(TYP.)+1V$, $I_O=0.5A$, $V_C=2.7V$, $T_a=25^\circ C$ (PQxxxEZ01Z))

Parameter		Symbol	Conditions	MIN.	TYP.	MAX.	Unit
Input voltage		V_{IN}	–	Refer to below table			V
Output voltage		V_O	–	Refer to below table			V
Load regulation	PQxxxEZ5MZ	R_{egL}	$I_O=5mA$ to 0.5A	–	0.2	2	%
	PQxxxEZ01Z		$I_O=5mA$ to 1A				
Line regulation		R_{egI}	$V_{IN}=V_O(TYP.)+1V$ to $V_O(TYP.)+6V$, $I_O=5mA$	–	0.1	1	%
Temperature coefficient of output voltage		$T_C V_O$	$T_j=0$ to $125^\circ C$, $I_O=5mA$	–	± 0.01	–	%/ $^\circ C$
Ripple Rejection		RR	Refer to Fig.2	45	60	–	dB
*4 Dropout voltage	PQxxxEZ5MZ	V_{I-O}	*5 $I_O=0.3A$	–	0.2	0.5	V
	PQxxxEZ01Z		*5 $I_O=0.5A$				
*6 ON-state voltage for control		$V_{C(ON)}$	–	2	–	–	V
ON-state current for control		$I_{C(ON)}$	–	–	–	200	μA
OFF-state voltage for control		$V_{C(OFF)}$	–	–	–	0.8	V
OFF-state current for control		$I_{C(OFF)}$	$V_C=0.4V$	–	–	2	μA
Quiescent current		I_q	$I_O=0A$	–	1	2	mA
Output OFF-state dissipation current		I_{qs}	$I_O=0A$, $V_C=0.4V$	–	–	5	μA

*4 Applied PQ030EZ5MZ, PQ033EZ5MZ

*5 Input voltage shall be the value when output voltage is 95% in comparison with the initial value.

*6 In case of opening control terminal (Ⓞ), output voltage turns off.

Input Voltage Line-up

(Unless otherwise specified, condition shall be $I_O=0.3A$, $V_C=2.7V$, $T_a=25^\circ C$ (PQxxxEZ5MZ))

(Unless otherwise specified, condition shall be $I_O=0.5A$, $V_C=2.7V$, $T_a=25^\circ C$ (PQxxxEZ01Z))

Model No.	Symbol	Conditions	MIN.	TYP.	MAX.	Unit
PQ015EZ5MZ/PQ015EZ01Z	V_{IN}	–	2.35	–	10	V
PQ018EZ5MZ/PQ018EZ01Z	V_{IN}	–	2.35	–	10	V
PQ025EZ5MZ/PQ025EZ01Z	V_{IN}	–	$V_O+0.5$	–	10	V
PQ030EZ5MZ/PQ030EZ01Z	V_{IN}	–	$V_O+0.5$	–	10	V
PQ033EZ5MZ/PQ033EZ01Z	V_{IN}	–	$V_O+0.5$	–	10	V

Output Voltage Line-up

(Unless otherwise specified, condition shall be $V_{IN}=V_O(TYP.)+1V$, $I_O=0.3A$, $V_C=2.7V$, $T_a=25^\circ C$ (PQxxxEZ5MZ))

(Unless otherwise specified, condition shall be $V_{IN}=V_O(TYP.)+1V$, $I_O=0.5A$, $V_C=2.7V$, $T_a=25^\circ C$ (PQxxxEZ01Z))

Model No.	Symbol	Conditions	MIN.	TYP.	MAX.	Unit
PQ015EZ5MZ/PQ015EZ01Z	V_O	–	1.45	1.5	1.55	V
PQ018EZ5MZ/PQ018EZ01Z	V_O	–	1.75	1.8	1.85	V
PQ025EZ5MZ/PQ025EZ01Z	V_O	–	2.438	2.5	2.562	V
PQ030EZ5MZ/PQ030EZ01Z	V_O	–	2.925	3	3.075	V
PQ033EZ5MZ/PQ033EZ01Z	V_O	–	3.218	3.3	3.382	V

Fig.1 Test Circuit

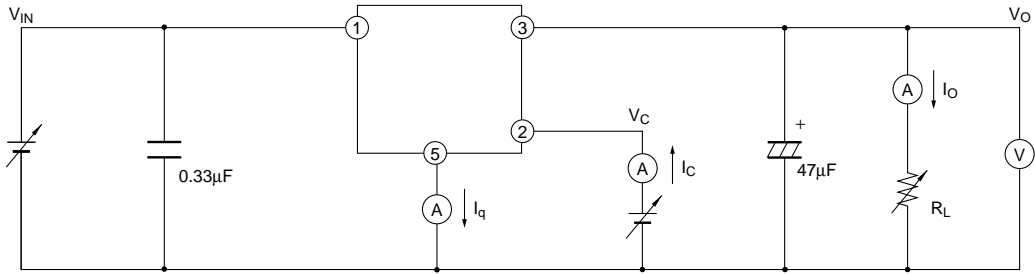
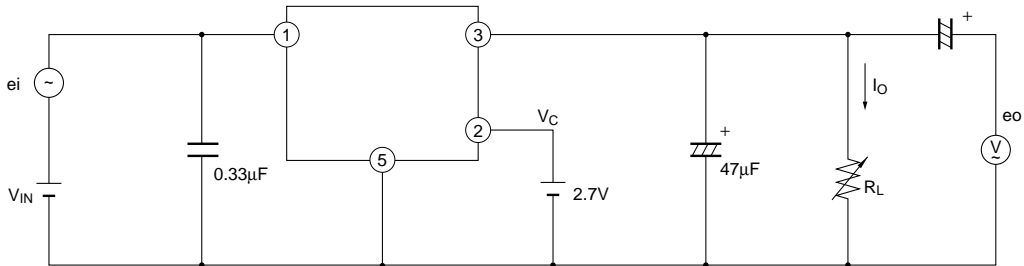
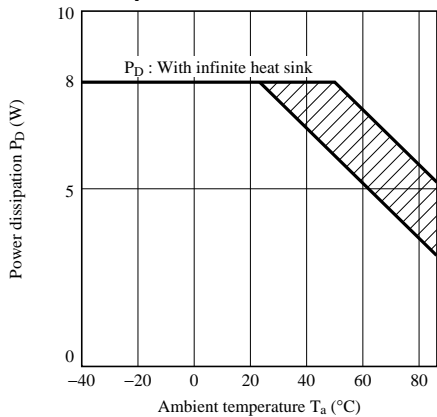

Fig.2 Test Circuit for Ripple Rejection



f=120Hz (sine wave)
 ei(rms)=0.5V
 $V_{IN}=V_O(\text{TYP})+2V$
 $I_O=0.3A$
 $RR=20\log(ei(\text{rms})/eo(\text{rms}))$

Fig.3 Power Dissipation vs. Ambient Temperature



Note) Oblique line portion: Overheat protection may operate in this area.

Fig.4 Overcurrent Protection Characteristics (PQ015EZ5MZ)

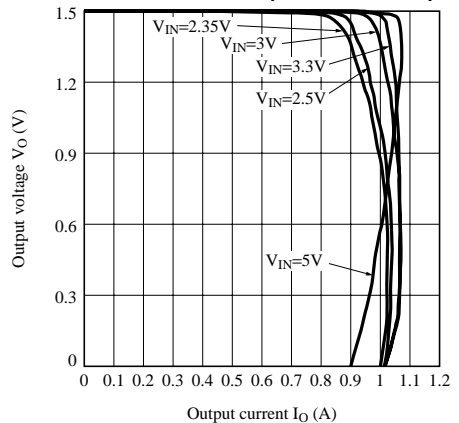

Fig.5 Overcurrent Protection Characteristics (PQ018EZ5MZ)

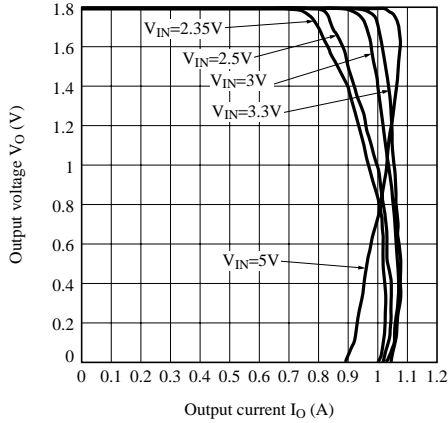

Fig.6 Overcurrent Protection Characteristics (PQ025EZ5MZ)

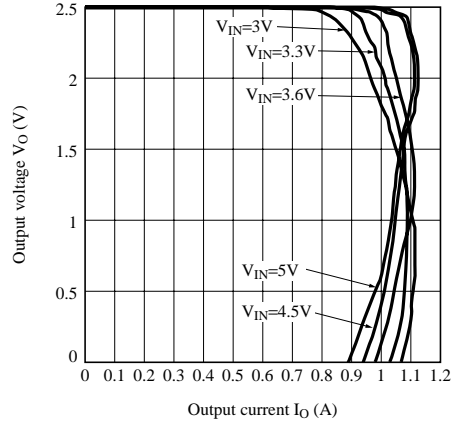

Fig.7 Overcurrent Protection Characteristics (PQ030EZ5MZ)

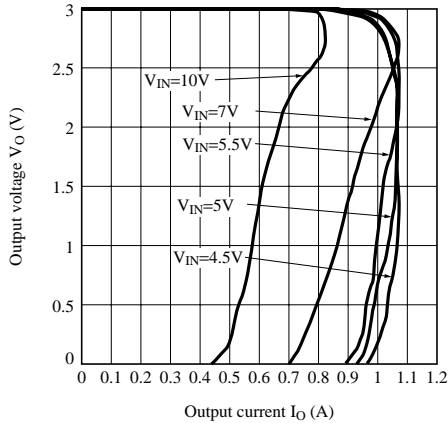

Fig.8 Overcurrent Protection Characteristics (PQ033EZ5MZ)

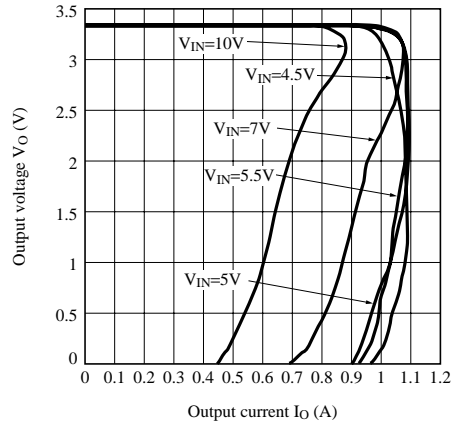

Fig.9 Overcurrent Protection Characteristics (PQ015EZ01Z)

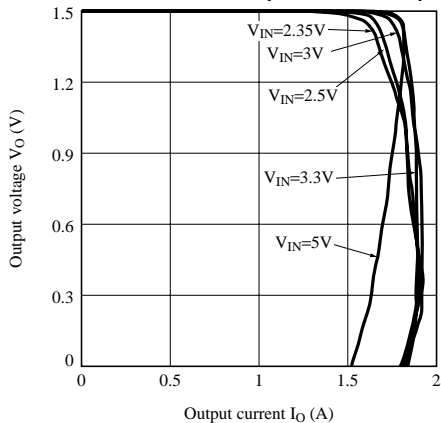

Fig.10 Overcurrent Protection Characteristics (PQ018EZ01Z)

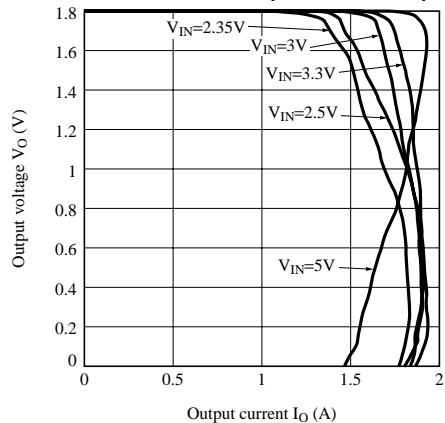

Fig.11 Overcurrent Protection Characteristics (PQ025EZ01Z)

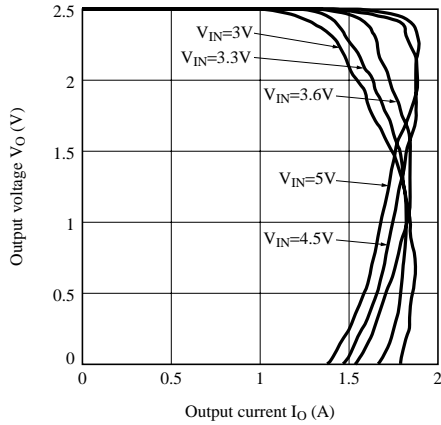

Fig.12 Overcurrent Protection Characteristics (PQ030EZ01Z)

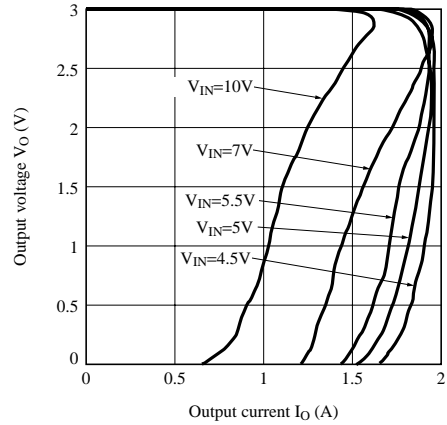

Fig.13 Overcurrent Protection Characteristics (PQ033EZ01Z)

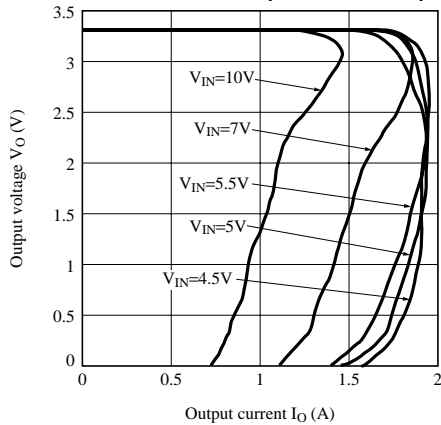

Fig.14 Output Voltage vs. Ambient Temperature (PQ015EZ5MZ/PQ015EZ01Z)

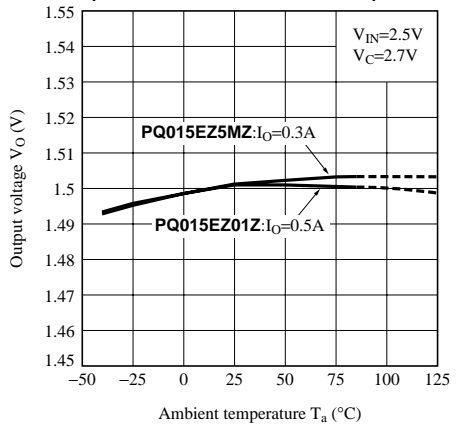

Fig.15 Output Voltage vs. Ambient Temperature (PQ018EZ5MZ/PQ018EZ01Z)

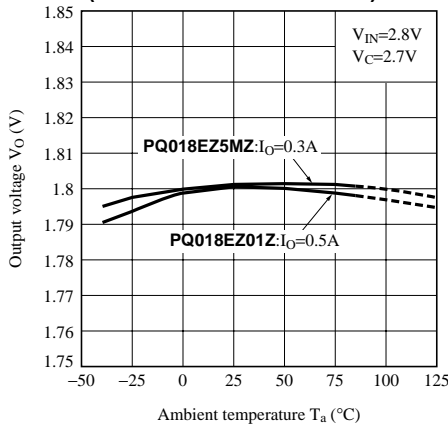

Fig.16 Output Voltage vs. Ambient Temperature (PQ025EZ5MZ/PQ025EZ01Z)

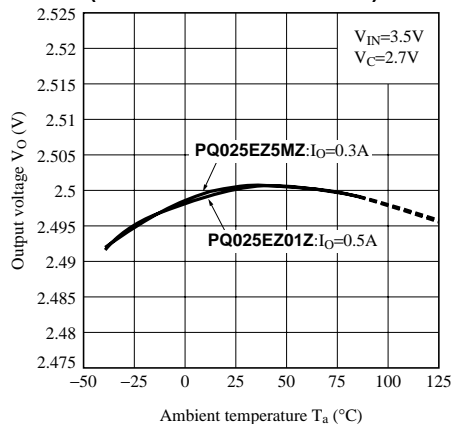

Fig.17 Output Voltage vs. Ambient Temperature (PQ030EZ5MZ/PQ030EZ01Z)

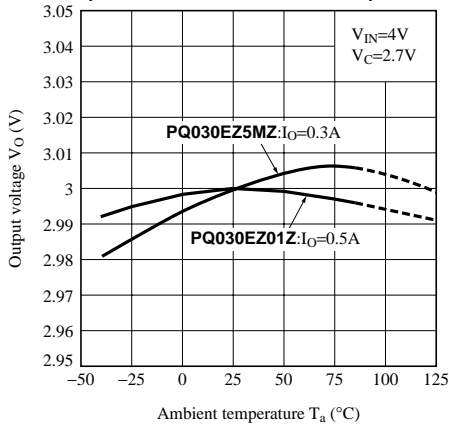

Fig.18 Output Voltage vs. Ambient Temperature (PQ033EZ5MZ/PQ033EZ01Z)

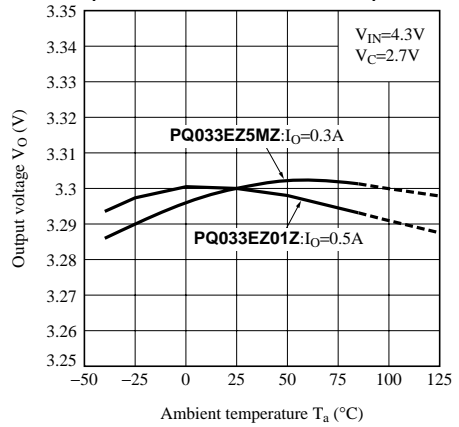

Fig.19 Output Voltage vs. Input Voltage (PQ015EZ5MZ)

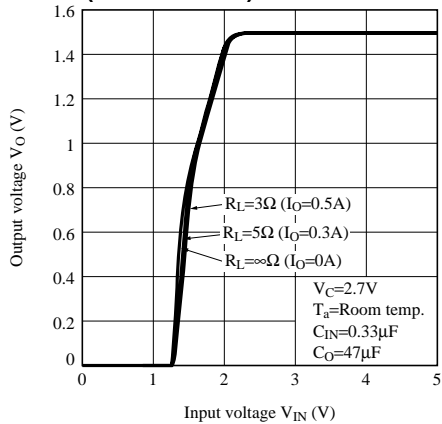

Fig.20 Output Voltage vs. Input Voltage (PQ018EZ5MZ)

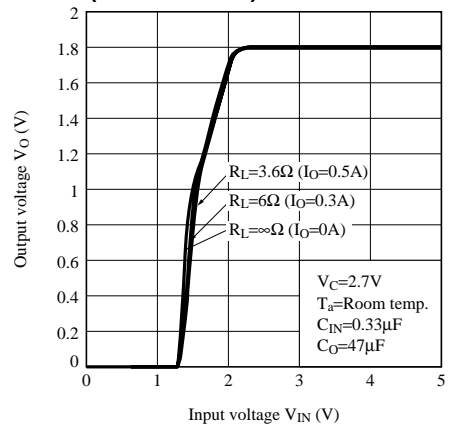

Fig.21 Output Voltage vs. Input Voltage (PQ025EZ5MZ)

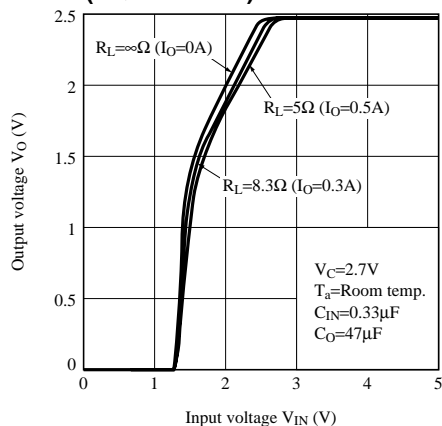

Fig.22 Output Voltage vs. Input Voltage (PQ030EZ5MZ)

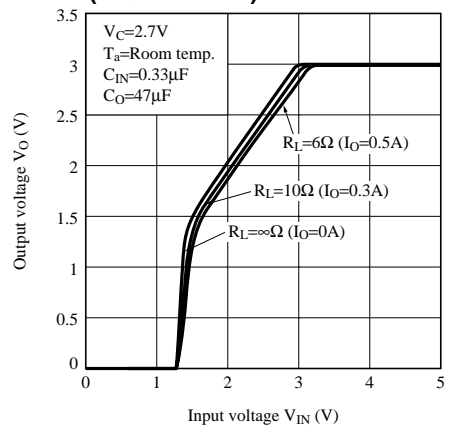

Fig.23 Output Voltage vs. Input Voltage (PQ033EZ5MZ)

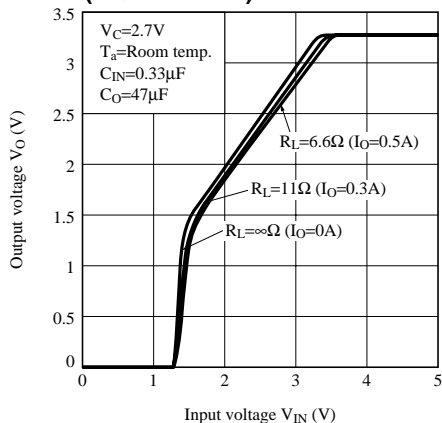

Fig.24 Output Voltage vs. Input Voltage (PQ015EZ01Z)

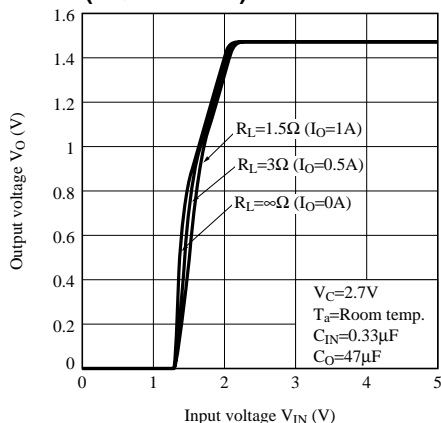

Fig.25 Output Voltage vs. Input Voltage (PQ018EZ01Z)

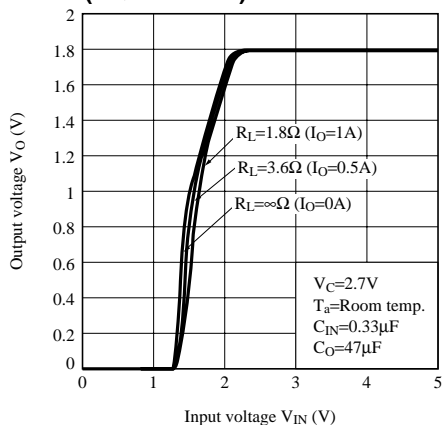

Fig.26 Output Voltage vs. Input Voltage (PQ025EZ01Z)

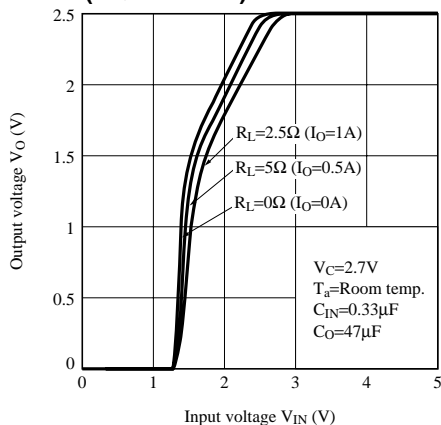

Fig.27 Output Voltage vs. Input Voltage (PQ030EZ01Z)

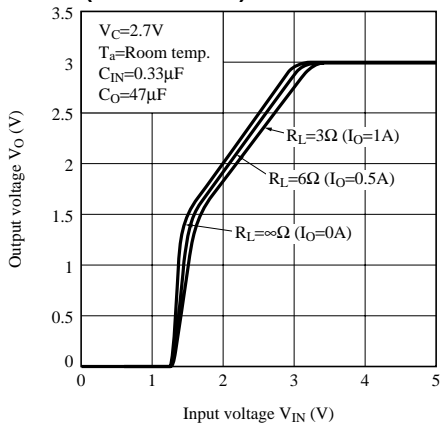

Fig.28 Output Voltage vs. Input Voltage (PQ033EZ01Z)

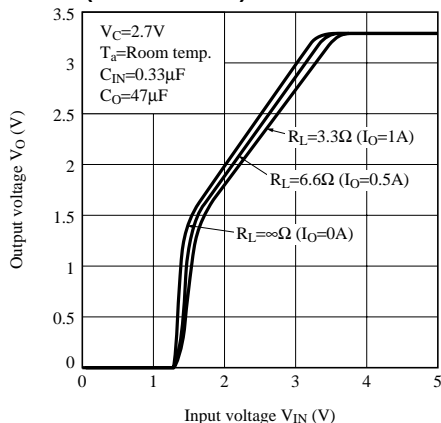

Fig.29 Circuit Operating Current vs. Input Voltage (PQ015EZ5MZ)

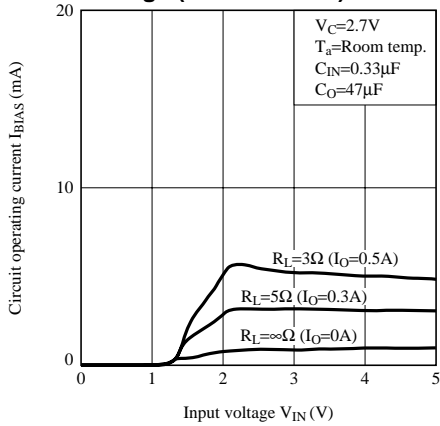

Fig.30 Circuit Operating Current vs. Input Voltage (PQ018EZ5MZ)

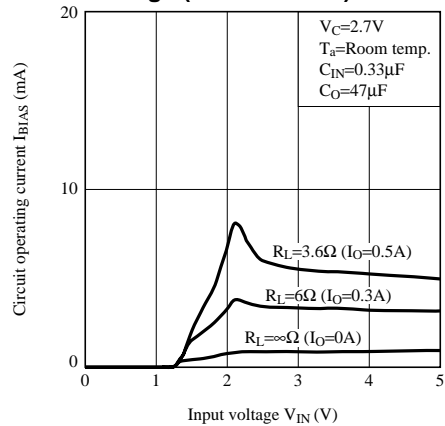

Fig.31 Circuit Operating Current vs. Input Voltage (PQ025EZ5MZ)

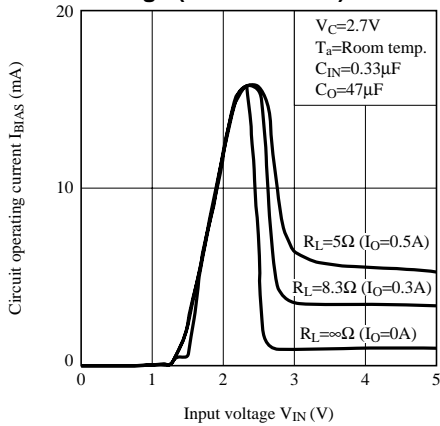

Fig.32 Circuit Operating Current vs. Input Voltage (PQ030EZ5MZ)

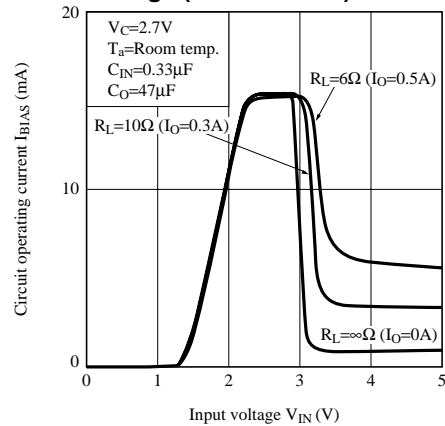

Fig.33 Circuit Operating Current vs. Input Voltage (PQ033EZ5MZ)

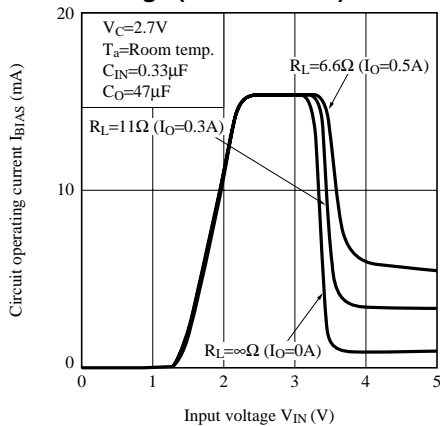

Fig.34 Circuit Operating Current vs. Input Voltage (PQ015EZ01Z)

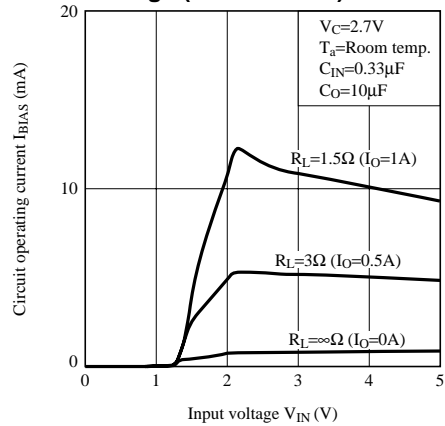

Fig.35 Circuit Operating Current vs. Input Voltage (PQ018EZ01Z)

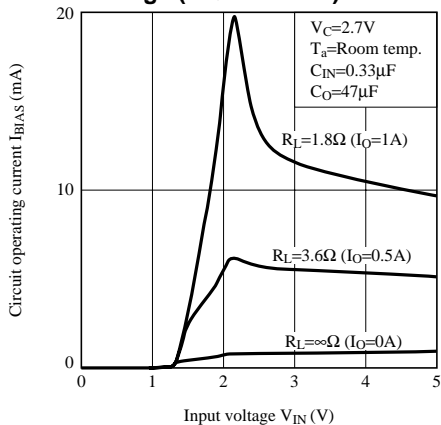

Fig.36 Circuit Operating Current vs. Input Voltage (PQ025EZ01Z)

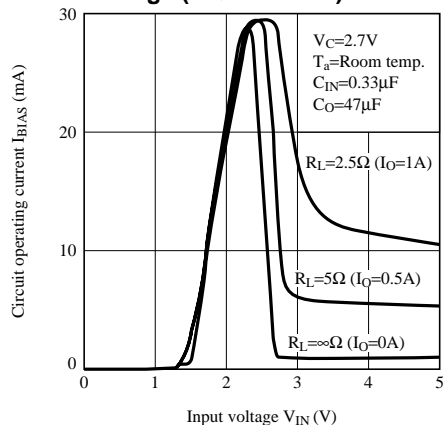

Fig.37 Circuit Operating Current vs. Input Voltage (PQ030EZ01Z)

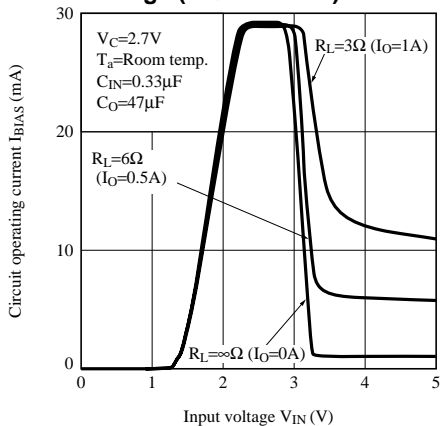

Fig.38 Circuit Operating Current vs. Input Voltage (PQ033EZ01Z)

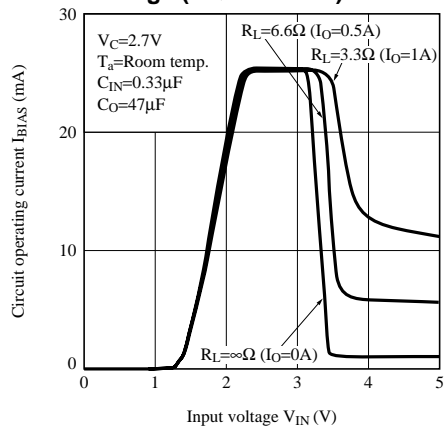

Fig.39 Quiescent Current vs. Junction Temperature

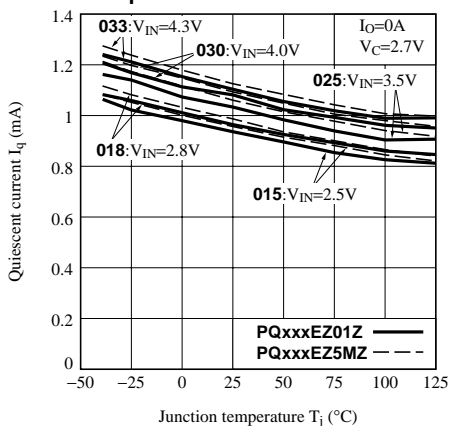

Fig.40 Dropout Voltage vs. Junction Temperature

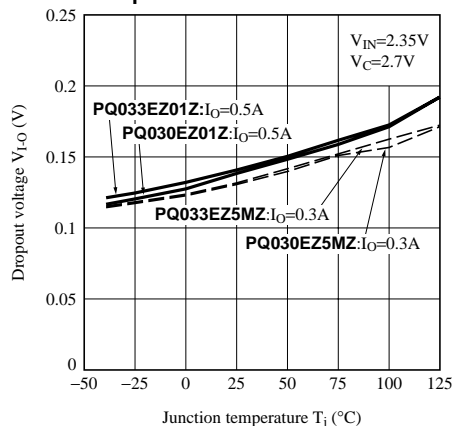

Fig.41 Ripple Rejection vs. Input Ripple Frequency

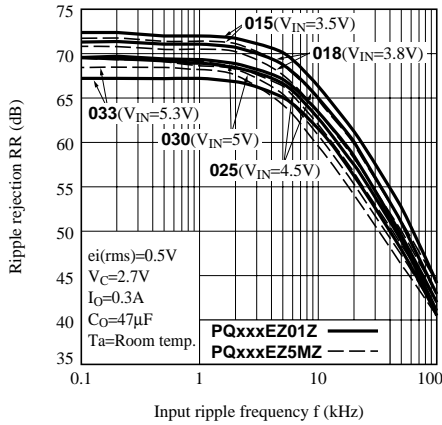

Fig.42 Ripple Rejection vs. Output Current

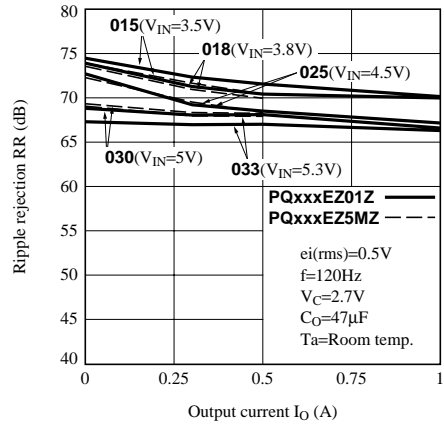

Fig.43 Typical Application

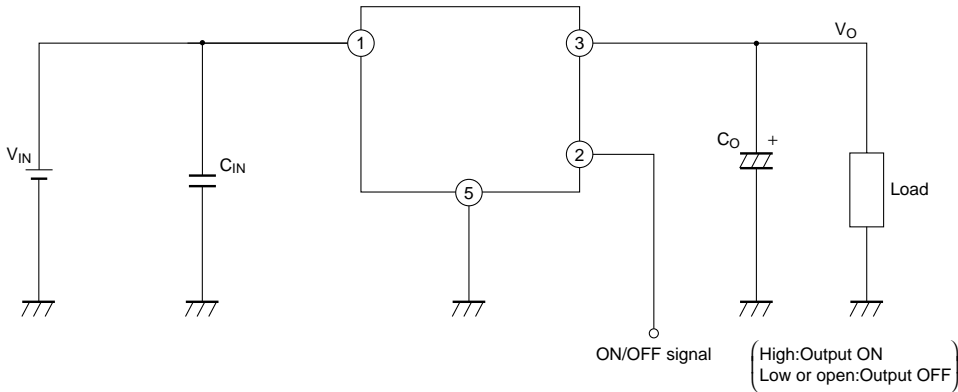
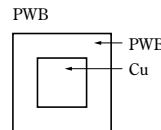
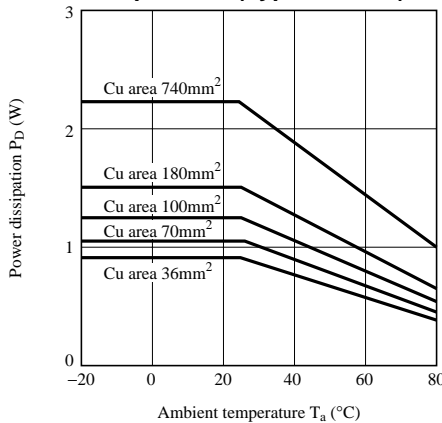

Fig.44 Power Dissipation vs. Ambient Temperature (Typical Value)



Material : Glass-cloth epoxy resin
 Size : 50x50x1.6mm
 Cu thickness : 35 μ m

NOTICE

- The circuit application examples in this publication are provided to explain representative applications of SHARP devices and are not intended to guarantee any circuit design or license any intellectual property rights. SHARP takes no responsibility for any problems related to any intellectual property right of a third party resulting from the use of SHARP's devices.
- Contact SHARP in order to obtain the latest device specification sheets before using any SHARP device. SHARP reserves the right to make changes in the specifications, characteristics, data, materials, structure, and other contents described herein at any time without notice in order to improve design or reliability. Manufacturing locations are also subject to change without notice.
- Observe the following points when using any devices in this publication. SHARP takes no responsibility for damage caused by improper use of the devices which does not meet the conditions and absolute maximum ratings to be used specified in the relevant specification sheet nor meet the following conditions:
 - (i) The devices in this publication are designed for use in general electronic equipment designs such as:
 - Personal computers
 - Office automation equipment
 - Telecommunication equipment [terminal]
 - Test and measurement equipment
 - Industrial control
 - Audio visual equipment
 - Consumer electronics
 - (ii) Measures such as fail-safe function and redundant design should be taken to ensure reliability and safety when SHARP devices are used for or in connection with equipment that requires higher reliability such as:
 - Transportation control and safety equipment (i.e., aircraft, trains, automobiles, etc.)
 - Traffic signals
 - Gas leakage sensor breakers
 - Alarm equipment
 - Various safety devices, etc.
 - (iii) SHARP devices shall not be used for or in connection with equipment that requires an extremely high level of reliability and safety such as:
 - Space applications
 - Telecommunication equipment [trunk lines]
 - Nuclear power control equipment
 - Medical and other life support equipment (e.g., scuba).
- Contact a SHARP representative in advance when intending to use SHARP devices for any "specific" applications other than those recommended by SHARP or when it is unclear which category mentioned above controls the intended use.
- If the SHARP devices listed in this publication fall within the scope of strategic products described in the Foreign Exchange and Foreign Trade Control Law of Japan, it is necessary to obtain approval to export such SHARP devices.
- This publication is the proprietary product of SHARP and is copyrighted, with all rights reserved. Under the copyright laws, no part of this publication may be reproduced or transmitted in any form or by any means, electronic or mechanical, for any purpose, in whole or in part, without the express written permission of SHARP. Express written permission is also required before any use of this publication may be made by a third party.
- Contact and consult with a SHARP representative if there are any questions about the contents of this publication.