

# PB51 • PB51A

## FEATURES

- WIDE SUPPLY RANGE —  $\pm 15V$  to  $\pm 150V$
- HIGH OUTPUT CURRENT —  
1.5A Continuous (PB51), 2.0A Continuous (PB51A)
- VOLTAGE AND CURRENT GAIN
- HIGH SLEW —  $50V/\mu s$  Minimum (PB51)  
 $75V/\mu s$  Minimum (PB51A)
- PROGRAMMABLE OUTPUT CURRENT LIMIT
- HIGH POWER BANDWIDTH — 320 kHz Minimum
- LOW QUIESCENT CURRENT — 12mA Typical
- EVALUATION KIT — EK29

## APPLICATIONS

- HIGH VOLTAGE INSTRUMENTATION
- ELECTROSTATIC TRANSDUCERS & DEFLECTION
- PROGRAMMABLE POWER SUPPLIES UP TO 280V P-P

## DESCRIPTION

The PB51 is a high voltage, high current amplifier designed to provide voltage and current gain for a small signal, general purpose op amp. Including the power booster within the feedback loop of the driver amplifier results in a composite amplifier with the accuracy of the driver and the extended output voltage range and current capability of the booster. The PB51 can also be used without a driver in some applications, requiring only an external current limit resistor to function properly.

The output stage utilizes complementary MOSFETs, providing symmetrical output impedance and eliminating second breakdown limitations imposed by Bipolar Transistors. Internal feedback and gainset resistors are provided for a pin-strapable gain of 3. Additional gain can be achieved with a single external resistor. Compensation is not required for most driver/gain configurations, but can be accomplished with a single external capacitor. Enormous flexibility is provided through the choice of driver amplifier, current limit, supply voltage, voltage gain, and compensation.

This hybrid circuit utilizes a beryllia (BeO) substrate, thick film resistors, ceramic capacitors and semiconductor chips to maximize reliability, minimize size and give top performance. Ultrasonically bonded aluminum wires provide reliable interconnections at all operating temperatures. The 12-pin Power SIP package is electrically isolated.

## TYPICAL APPLICATION

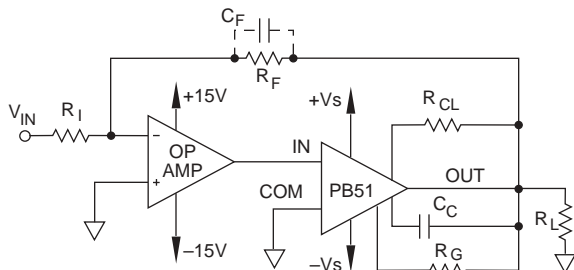
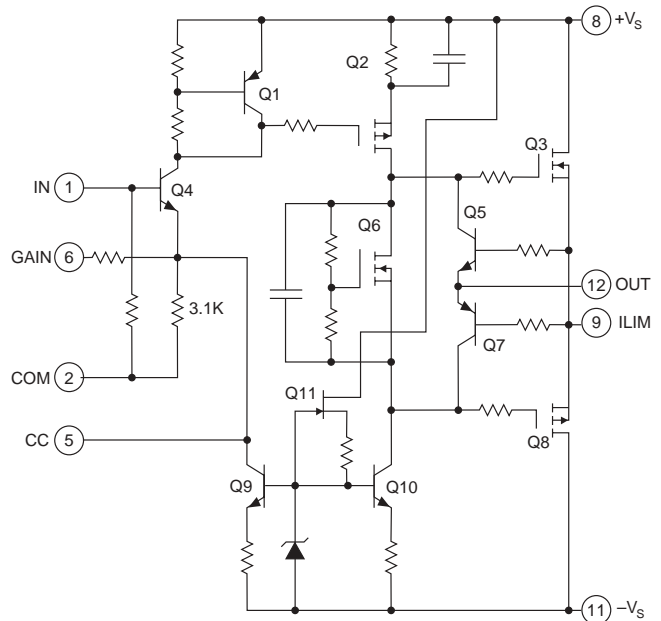

FIGURE 1. INVERTING COMPOSITE AMPLIFIER.



## EQUIVALENT SCHEMATIC



## EXTERNAL CONNECTIONS

PACKAGE: SIP03

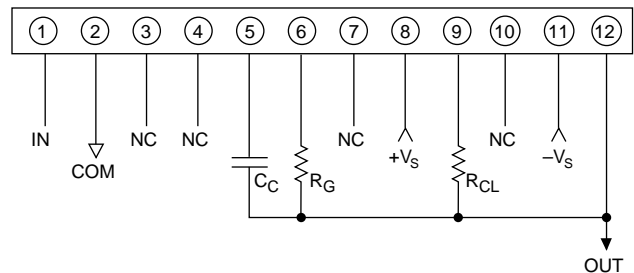

# PB51 • PB51A

## ABSOLUTE MAXIMUM RATINGS SPECIFICATIONS

### ABSOLUTE MAXIMUM RATINGS

SUPPLY VOLTAGE, $+V_S$ to $-V_S$	300V
OUTPUT CURRENT, within SOA	2.0A
POWER DISSIPATION, internal at $T_C = 25^\circ\text{C}$ <sup>1</sup>	83W
INPUT VOLTAGE, referred to COM	$\pm 15\text{V}$
TEMPERATURE, pin solder—10 sec max	220°C
TEMPERATURE, junction <sup>1</sup>	175°C
TEMPERATURE, storage	-65 to +150°C
OPERATING TEMPERATURE RANGE, case	-55 to +125°C

### SPECIFICATIONS

PARAMETER	TEST CONDITIONS <sup>2</sup>	PB51			PB51A			UNITS	
		MIN	TYP	MAX	MIN	TYP	MAX		
<b>INPUT</b>									
OFFSET VOLTAGE, initial	Full temperature range <sup>3</sup>		$\pm 0.75$	$\pm 1.75$		*	$\pm 1.0$	V	
OFFSET VOLTAGE, vs. temperature				-4.5	-7		*	*	mV/°C
INPUT IMPEDANCE, DC		25	50		*	*		k	
INPUT CAPACITANCE			3			*		pF	
CLOSED LOOP GAIN RANGE		3	10	25	*	*	*	V/V	
GAIN ACCURACY, internal R <sub>g</sub> , R <sub>f</sub>		AV = 3		$\pm 10$	$\pm 15$		*	*	%
GAIN ACCURACY, external R <sub>f</sub>		AV = 10		$\pm 15$	$\pm 25$		*	*	%
PHASE SHIFT		f = 10kHz, AV <sub>C</sub> = 10, CC = 22pF		10			*		°
	f = 200kHz, AV <sub>C</sub> = 10, CC = 22pF		60			*		°	
<b>OUTPUT</b>									
VOLTAGE SWING	Io = 1.5A (PB58), 2A (PB58A)	VS-11	VS-8		VS-15	VS-11		V	
VOLTAGE SWING	Io = 1A	VS-10	VS-7		*	*		V	
VOLTAGE SWING	Io = .1A	VS-8	VS-5		*	*		V	
CURRENT, continuous		1.5			2.0			A	
SLEW RATE	Full temperature range	50	100		75	*		V/μs	
CAPACITIVE LOAD	Full temperature range		2200			*		pF	
SETTLING TIME to .1%	RL = 100, 2V step		2			*		μs	
POWER BANDWIDTH	VC = 100 Vpp	160	320		240	*		kHz	
SMALL SIGNAL BANDWIDTH	CC = 22pF, AV = 25, Vcc = $\pm 100$		100			*		kHz	
SMALL SIGNAL BANDWIDTH	CC = 22pF, AV = 3, Vcc = $\pm 30$		1			*		MHz	
<b>POWER SUPPLY</b>									
VOLTAGE, $\pm V_S4$	Full temperature range	$\pm 156$	$\pm 60$	$\pm 150$	*	*	*	V	
CURRENT, quiescent	VS = $\pm 15$		11			*		mA	
	VS = $\pm 60$		12			*		mA	
	VS = $\pm 150$		14	18		*	*	mA	
<b>THERMAL</b>									
RESISTANCE, AC junction to case <sup>5</sup>	Full temp. range, f > 60Hz		1.2	1.3		*	*	°C/W	
RESISTANCE, DC junction to case	Full temp. range, f < 60Hz		1.6	1.8		*	*	°C/W	
RESISTANCE, junction to air	Full temperature range		30			*	*	°C/W	
TEMPERATURE RANGE, case	Meets full range specifications	-25	25	85	*	*	*	°C	

NOTES: \* The specification of PB51A is identical to the specification for PB51 in applicable column to the left.

1. Long term operation at the maximum junction temperature will result in reduced product life. Derate internal power dissipation to achieve high MTTF (Mean Time to Failure).
2. The power supply voltage specified under typical (TYP) applies,  $T_C = 25^\circ\text{C}$  unless otherwise noted.
3. Guaranteed by design but not tested.
4.  $+V_S$  and  $-V_S$  denote the positive and negative supply rail respectively.
5. Rating applies if the output current alternates between both output transistors at a rate faster than 60Hz.
6.  $+V_S/-V_S$  must be at least 15V above/below COM.

**CAUTION** The PB51 is constructed from MOSFET transistors. ESD handling procedures must be observed.

The internal substrate contains beryllia (BeO). Do not break the seal. If accidentally broken, do not crush, machine, or subject to temperatures in excess of 850°C to avoid generating toxic fumes.

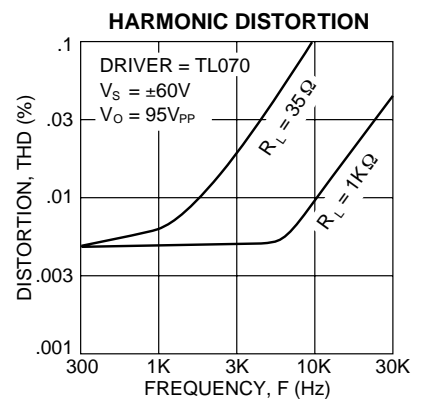
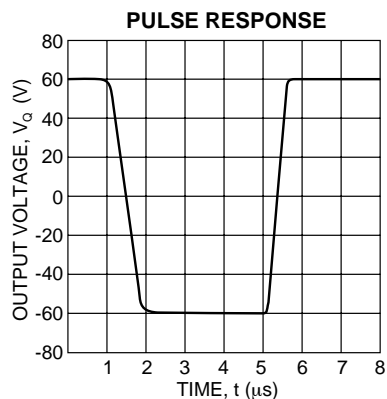
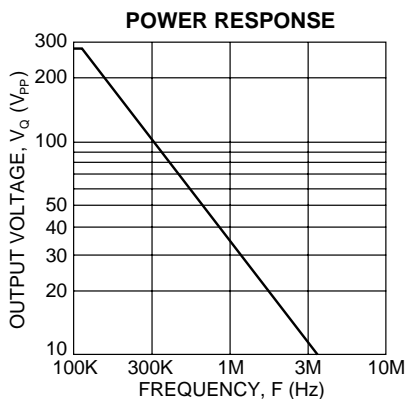
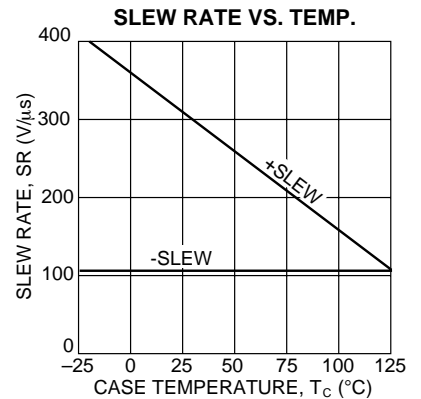
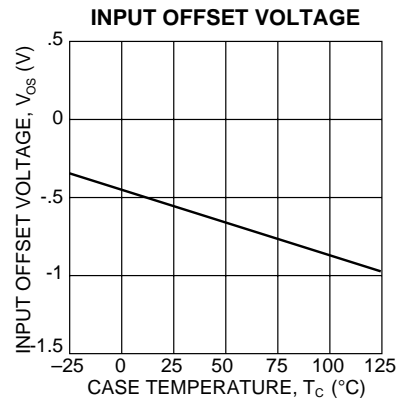
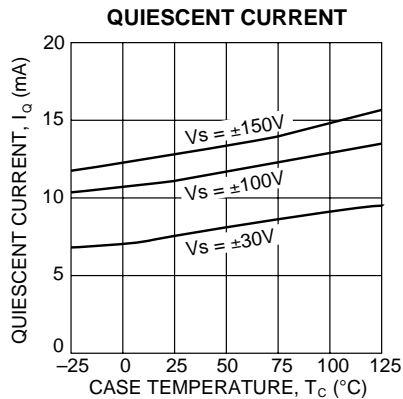
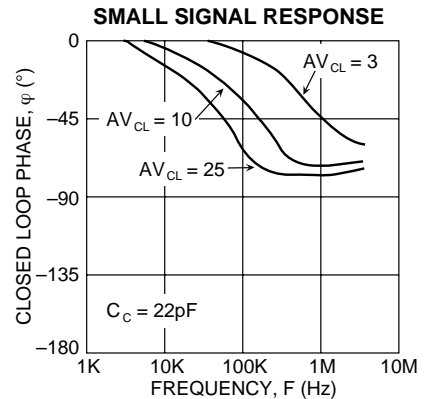
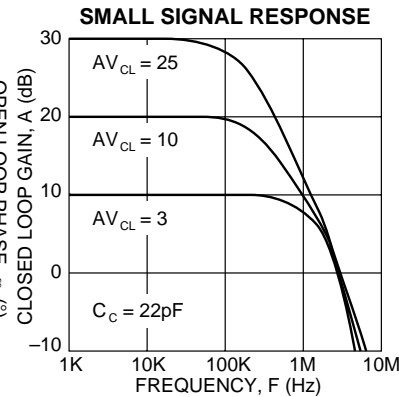
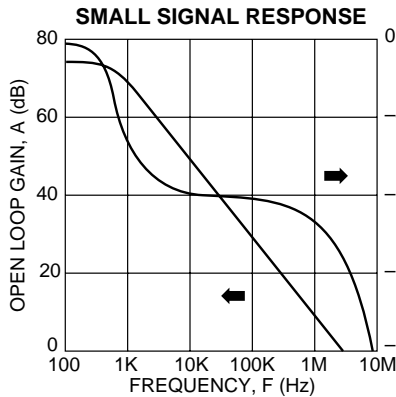
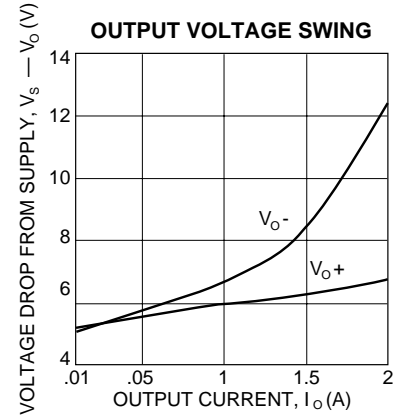
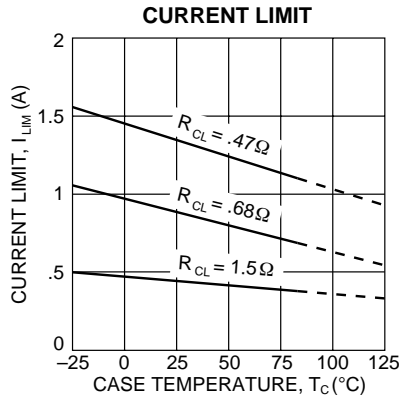
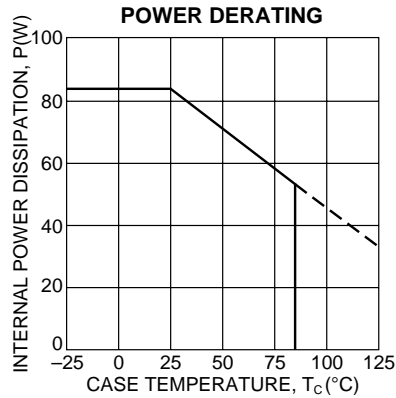

### GENERAL

Please read Application Note 1 "General Operating Considerations" which covers stability, supplies, heat sinking, mounting, current limit, SOA interpretation, and specification interpretation. Visit [www.apexmicrotech.com](http://www.apexmicrotech.com) for design tools that help automate tasks such as calculations for stability, internal power dissipation, current limit; heat sink selection; Apex's complete Application Notes library; Technical Seminar Workbook; and Evaluation Kits.

### CURRENT LIMIT

For proper operation, the current limit resistor ( $R_{CL}$ ) must be connected as shown in the external connection diagram. The minimum value is 0.33 with a maximum practical value of 47. For optimum reliability the resistor value should be set as high as possible. The value is calculated as follows:

$$+I_L = .65/R_{CL} + .010, -I_L = .65/R_{CL}$$

### SAFE OPERATING AREA (SOA)

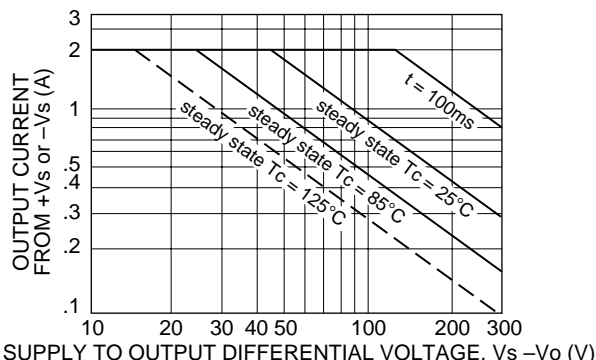

NOTE: The output stage is protected against transient flyback. However, for protection against sustained, high energy flyback, external fast-recovery diodes should be used.

### COMPOSITE AMPLIFIER CONSIDERATIONS

Cascading two amplifiers within a feedback loop has many advantages, but also requires careful consideration of several amplifier and system parameters. The most important of these are gain, stability, slew rate, and output swing of the driver. Operating the booster amplifier in higher gains results in a higher slew rate and lower output swing requirement for the driver, but makes stability more difficult to achieve.

### GAIN SET

$$R_G = [(Av-1) * 3.1K] - 6.2K$$

$$Av = \frac{R_G + 6.2K}{3.1K} + 1$$

The booster's closed-loop gain is given by the equation above. The composite amplifier's closed loop gain is determined by the feedback network, that is:  $-R_f/R_i$  (inverting) or  $1+R_f/R_i$  (non-inverting). The driver amplifier's "effective gain" is equal to the composite gain divided by the booster gain.

Example: Inverting configuration (figure 1) with

$$R_i = 2K, R_f = 60K, R_g = 0 :$$

$$Av (\text{booster}) = (6.2K/3.1K) + 1 = 3$$

$$Av (\text{composite}) = 60K/2K = -30$$

$$Av (\text{driver}) = -30/3 = -10$$

### STABILITY

Stability can be maximized by observing the following guidelines:

1. Operate the booster in the lowest practical gain.
2. Operate the driver amplifier in the highest practical effective gain.
3. Keep gain-bandwidth product of the driver lower than the closed loop bandwidth of the booster.
4. Minimize phase shift within the loop.

A good compromise for (1) and (2) is to set booster gain from 3 to 10 with total (composite) gain at least a factor of 3 times booster gain. Guideline (3) implies compensating the driver as required in low composite gain configurations. Phase shift within the loop (4) is minimized through use of booster and loop compensation capacitors  $C_c$  and  $C_f$  when required. Typical values are 5pF to 33pF.

Stability is the most difficult to achieve in a configuration where driver effective gain is unity (ie; total gain = booster gain). For this situation, Table 1 gives compensation values for optimum square wave response with the op amp drivers listed.

DRIVER	$C_{CH}$	$C_F$	$C_C$	FPBW	SR
OP07	-	22p	22p	4kHz	1.5
741	-	18p	10p	20kHz	7
LF155	-	4.7p	10p	60kHz	>60
LF156	-	4.7p	10p	80kHz	>60
TL070	22p	15p	10p	80kHz	>60

For:  $R_f = 33K, R_i = 3.3K, R_g = 22K$

TABLE 1. TYPICAL VALUES FOR CASE WHERE OP AMP EFFECTIVE GAIN = 1.

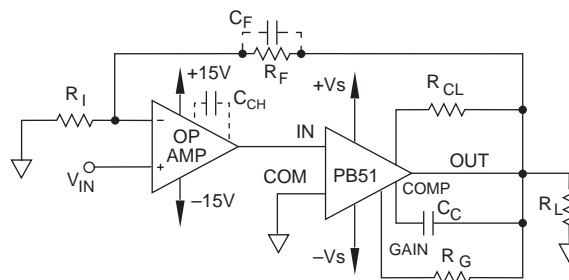

FIGURE 2. NON-INVERTING COMPOSITE AMPLIFIER.

### SLEW RATE

The slew rate of the composite amplifier is equal to the slew rate of the driver times the booster gain, with a maximum value equal to the booster slew rate.

### OUTPUT SWING

The maximum output voltage swing required from the driver op amp is equal to the maximum output swing from the booster divided by the booster gain. The  $V_{os}$  of the booster must also be supplied by the driver, and should be subtracted from the available swing range of the driver. Note also that effects of  $V_{os}$  drift and booster gain accuracy should be considered when calculating maximum available driver swing.