

**LV1150****Virtual Surround System IC****Overview**

The LV1150 is a virtual surround system Bi-CMOS IC for video soundtracks and audio.

The main feature of this IC is the ability to create an audio ambience equivalent to that of a multichannel system by adding a signal to which virtual surround processing has been applied to the left and right channel input signals. It furthermore allows modification of this effect by the use of L+R and L-R passive matrix processing and adjustment of the surround processing level with a level control.

Functions and Features

- Virtual surround function
- Passive matrix: L+R, L-R
- Adjustable surround effect level
- Bypass and virtual surround (L+R, L-R) switching function
- Output filters are provided on chip.
- On-chip V_{DD} circuit
- ADM technique based A/D and D/A converters
- Simulated stereo for monaural input signals
- Package: DIP24S

Specifications**Absolute Maximum Ratings at $T_a = 25^\circ\text{C}$**

Parameter	Symbol	Conditions	Ratings	Unit
Maximum supply voltage	V_{CCmax}		12	V
Allowable power dissipation	P_{dmax}	$T_a \leq 70^\circ\text{C}$ * With printed circuit board	700	W
Operating temperature	T_{opr}		-20 to +70	$^\circ\text{C}$
Storage temperature	T_{stg}		-40 to +125	$^\circ\text{C}$

Note: * Printed circuit board size: 114.3 × 76.1 mm, t = 1.6 mm. Material: Glass epoxy.

Package Dimensions

unit: mm

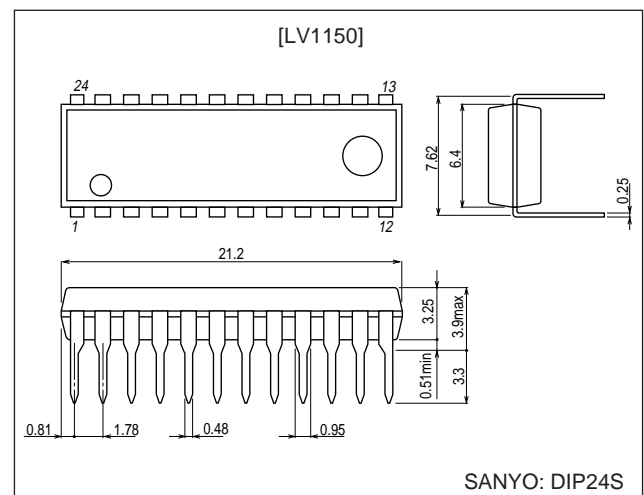
3067-DIP24S

■ Any and all SANYO products described or contained herein do not have specifications that can handle applications that require extremely high levels of reliability, such as life-support systems, aircraft's control systems, or other applications whose failure can be reasonably expected to result in serious physical and/or material damage. Consult with your SANYO representative nearest you before using any SANYO products described or contained herein in such applications.

■ SANYO assumes no responsibility for equipment failures that result from using products at values that exceed, even momentarily, rated values (such as maximum ratings, operating condition ranges, or other parameters) listed in products specifications of any and all SANYO products described or contained herein.

SANYO Electric Co.,Ltd. Semiconductor Company

TOKYO OFFICE Tokyo Bldg., 1-10, 1 Chome, Ueno, Taito-ku, TOKYO, 110-8534 JAPAN

LV1150

Operating Conditions at $T_a = 25^\circ\text{C}$

Parameter	Symbol	Conditions	Ratings	Unit
Recommended supply voltage	V_{CC}		7	V
Operating supply voltage range	V_{CCopr}		6.5 to 10	V

Electrical Characteristics at $T_a = 25^\circ\text{C}$, $V_{CC} = 7.0\text{ V}$, $V_{IN} = -10\text{ dBm}$, $f = 1\text{ kHz}$, in bypass mode

Parameter	Symbol	Conditions	Ratings			Unit
			min	typ	max	
Quiescent current	I_{CC}		15	40	60	mA
Output noise voltage	V_{NO}	$R_s = 10\text{ k}\Omega$, JIS A		-110	-90	dBm
		In virtual surround mode		-88	-80	dBm
I/O signal level deviation	V_O	$V_{IN} = -10\text{ dBm} = 0\text{ dB}$	-2	0	+2	dB
Total harmonic distortion	THD	400 Hz to 30 kHz bandpass filter		0.005	0.03	%
		In virtual surround mode		0.13	1.0	%
Headroom	$H \cdot R$	$V_{IN} = -10\text{ dBm} = 0\text{ dB}$, THD = 1%	10	15		dB
		In virtual surround mode	10	12		dB

Block Diagram

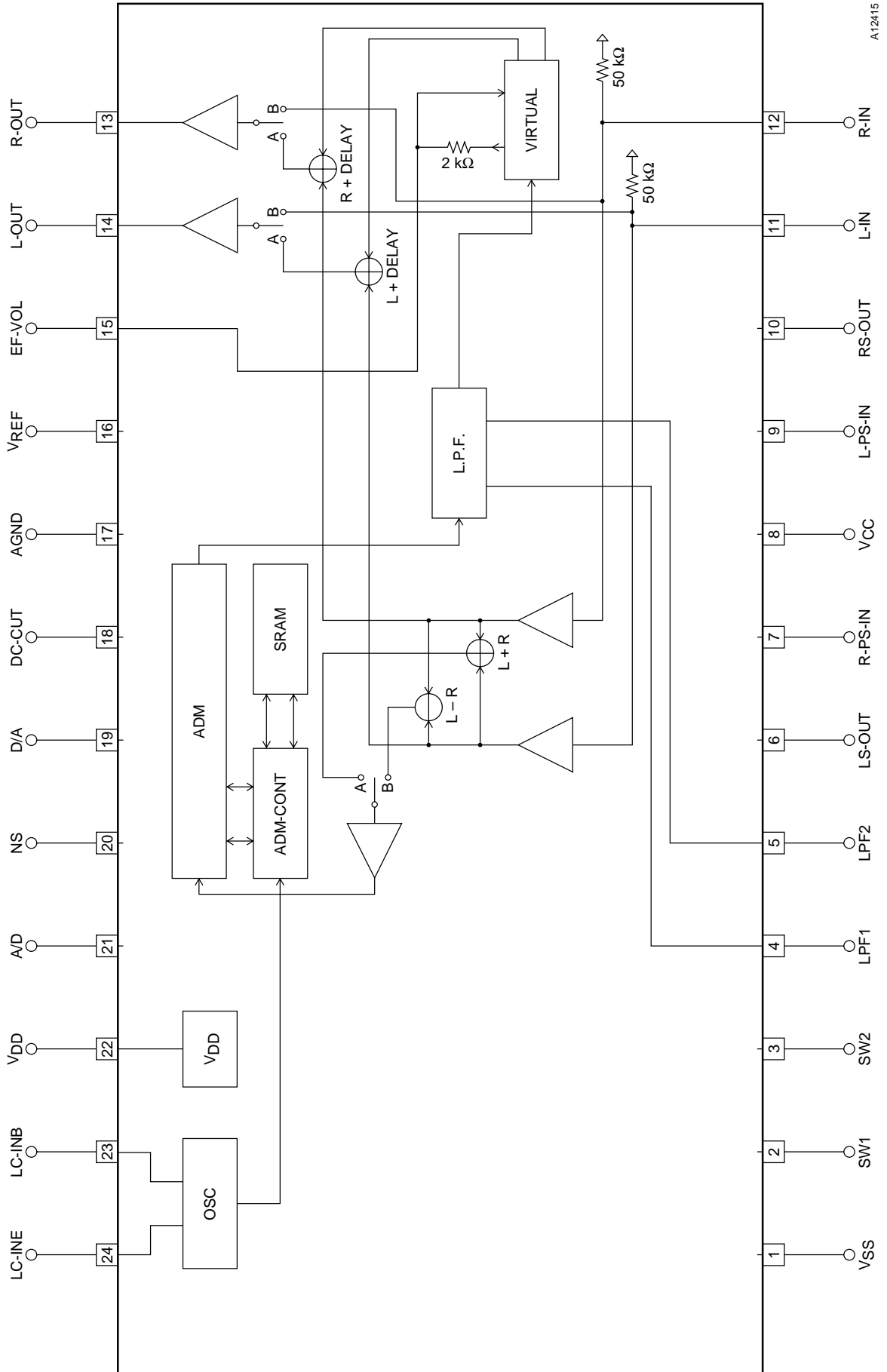

A12415

Test Circuit Example

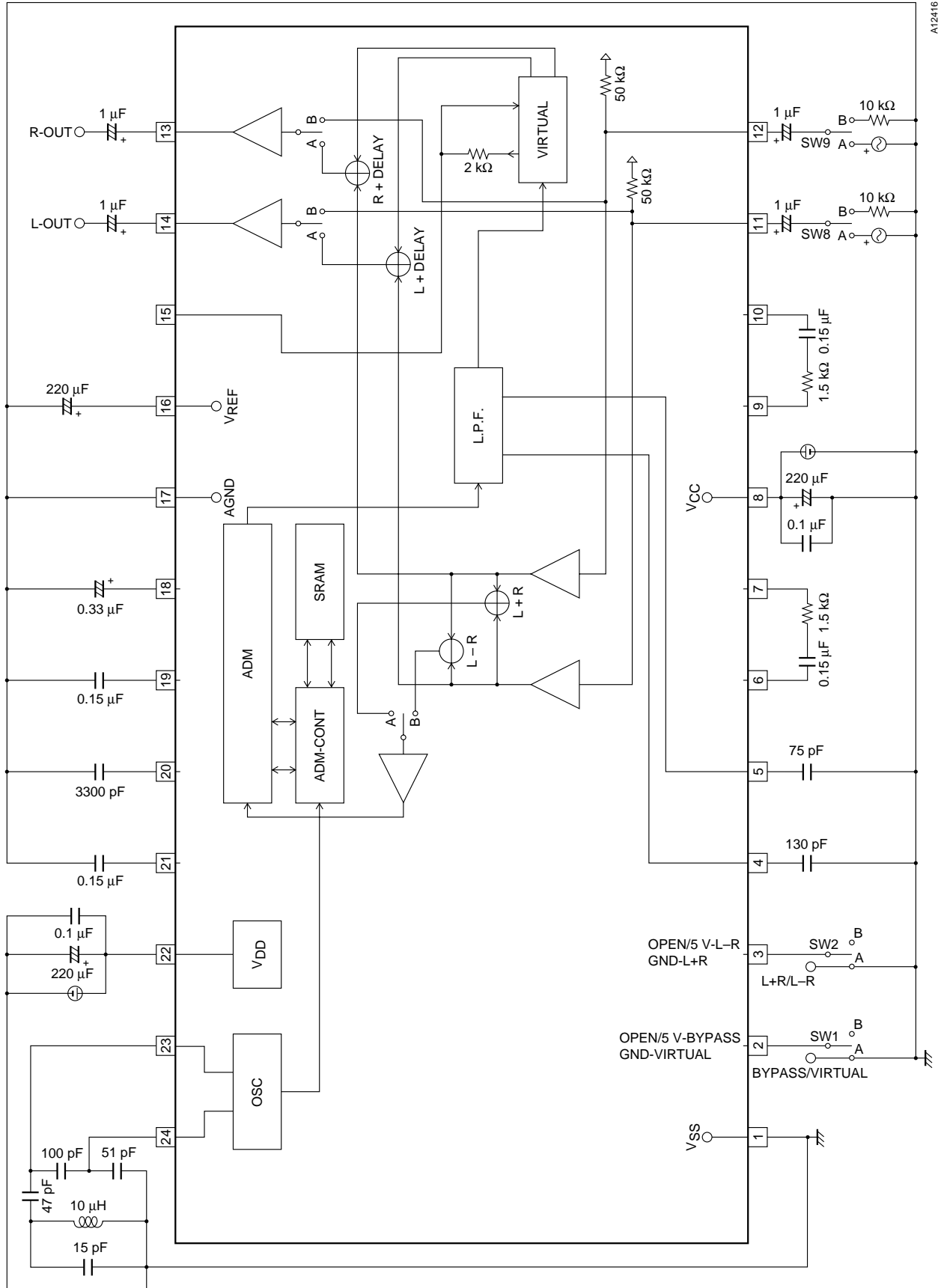

A12416

Application Circuit Example

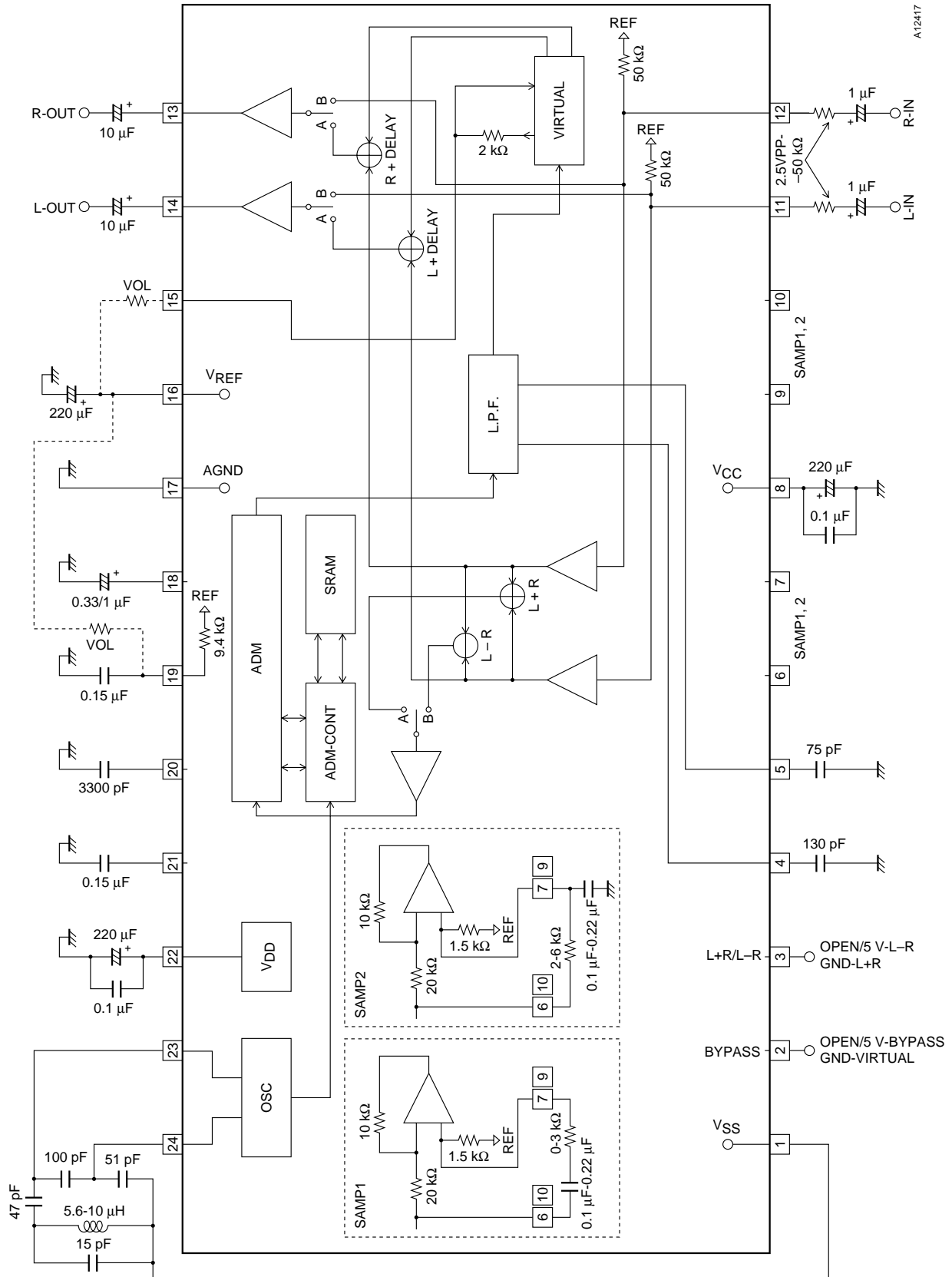

A12417

Operating Principles

1. Modes

The mode can be set using DIP switches on pins 2 and 3.

- Bypass/virtual: switches between bypass and virtual modes.
- L+R/L-R: Switches the virtual mode effect.

Since this switching is independent of the bypass function, it has no effect in bypass mode.

2. Other notes

- The level of the virtual effect can be changed by the values of the external resistors connected to pins 15 and 19. (See the sample application circuit diagram.) Note that the effect is maximum when these pins are open.
- There are two options that may be attached to pins 6 and 7 and pins 9 and 10. (See the sample application circuit diagram.) High boost (SAMP1) and low boost (SAMP2) effects can be acquired using external circuits on these pins. (See the charts.)

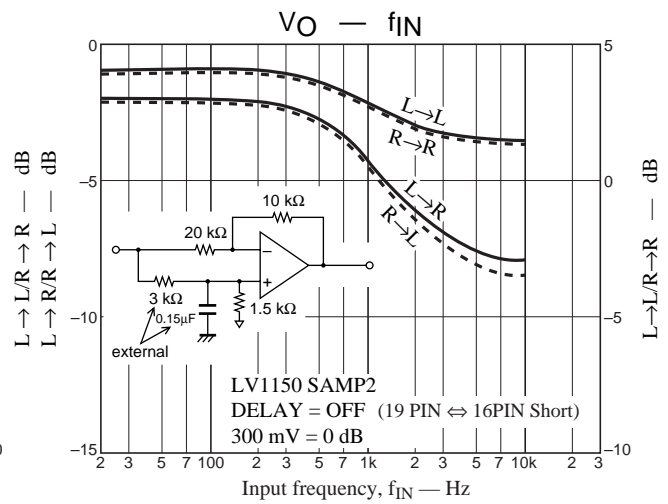
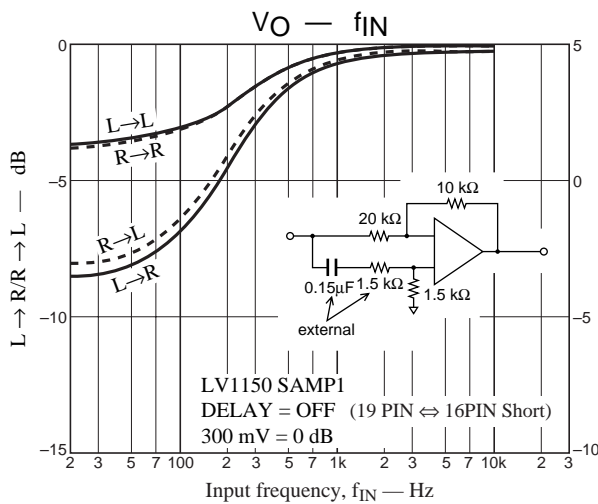

Pin Descriptions

Pin No.	Pin	Pin voltage (V)	Function	Equivalent circuit
2	SW1	0/0.7	Bypass/virtual switching	
3	SW1		L+R/L-R switching	
4 5	LPF1 LPF2	1/2V _{CC}	Low-pass filter capacitor connection	
6 10	LS-OUT RS-OUT	1/2V _{CC}	Surround signal outputs	
7 9	R-PS-IN L-PS-IN	1/2V _{CC}	Virtual surround processing signal inputs.	

Continued on next page.

LV1150

Continued from preceding page.

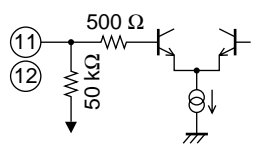
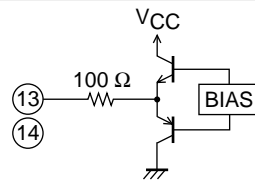
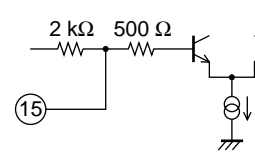
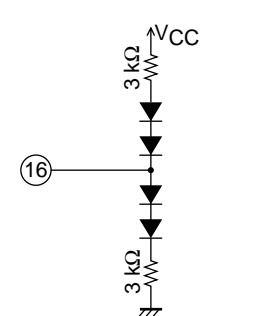
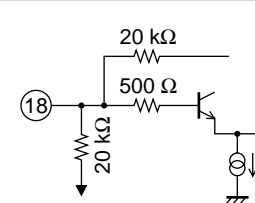
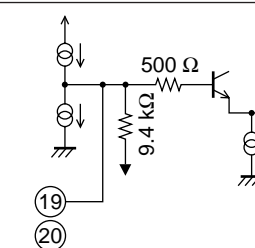
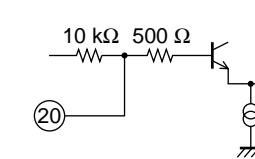
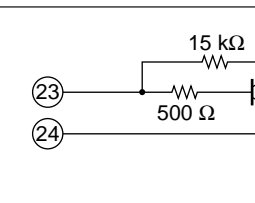
Pin No.	Pin	Pin voltage	Function	Equivalent circuit
11 12	L-IN R-IN	$1/2V_{CC}$	Signal inputs	 <p style="text-align: right;">A12422</p>
13 14	R-OUT L-OUT	$1/2V_{CC}$	Signal outputs	 <p style="text-align: right;">A12423</p>
15	EF-VOL	$1/2V_{CC}$	Virtual surround control	 <p style="text-align: right;">A12424</p>
16	V _{REF}	$1/2V_{CC}$	V _{REF} amplifier reference	 <p style="text-align: right;">A12425</p>
18	DC-CUT	$1/2V_{CC}$	DC cut capacitor connection	 <p style="text-align: right;">A12426</p>
19 21	D/A A/D	$1/2V_{CC}$	A/D (D/A) converter integrator capacitor connection	 <p style="text-align: right;">A12427</p>
20	NS	$1/2V_{CC}$	A/D noise shaper capacitor connection	 <p style="text-align: right;">A12428</p>
23 24	LC-INB LC-INE	0/5V	Clock control	 <p style="text-align: right;">A12429</p>

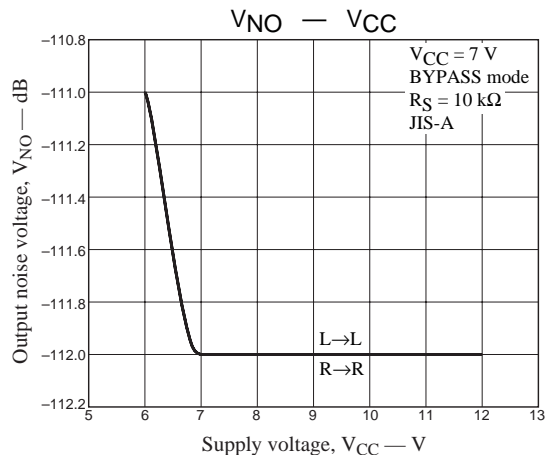
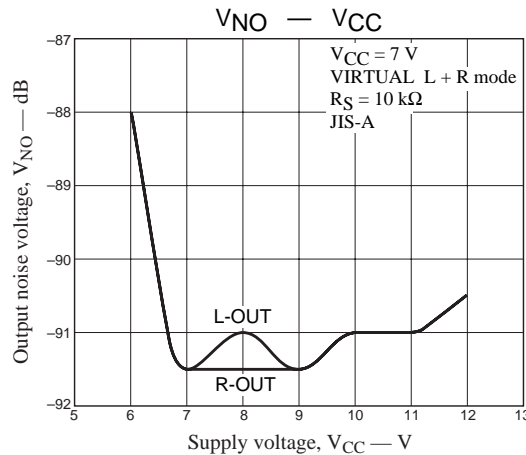
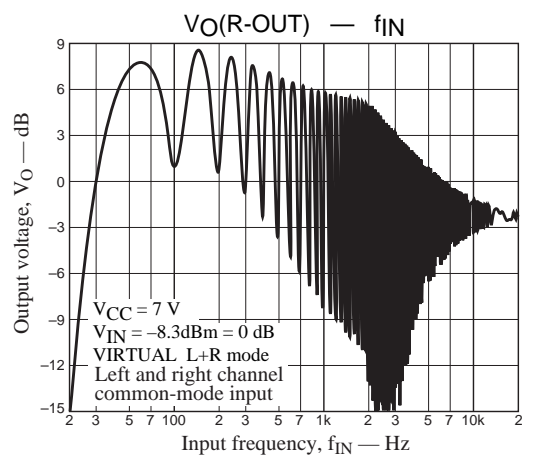
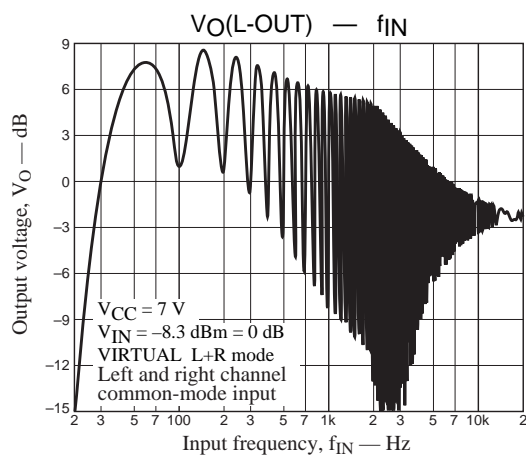
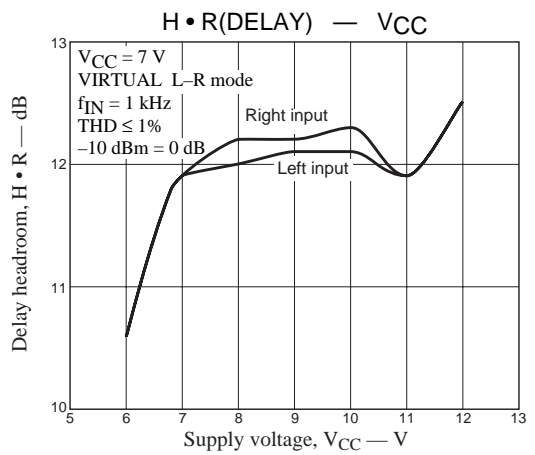
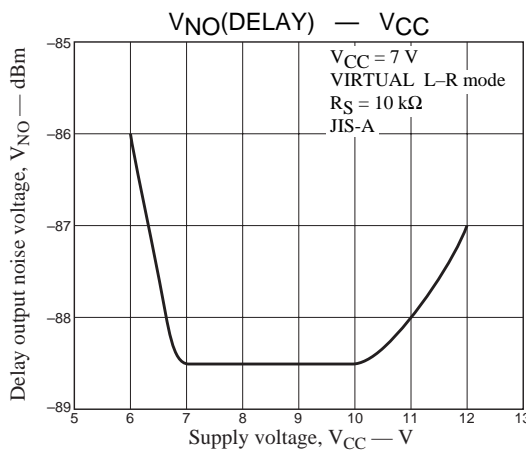
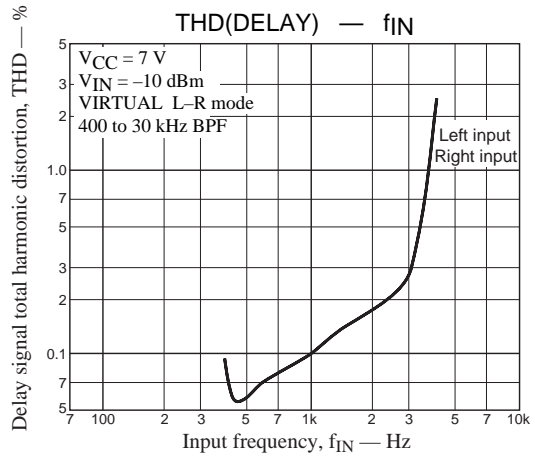
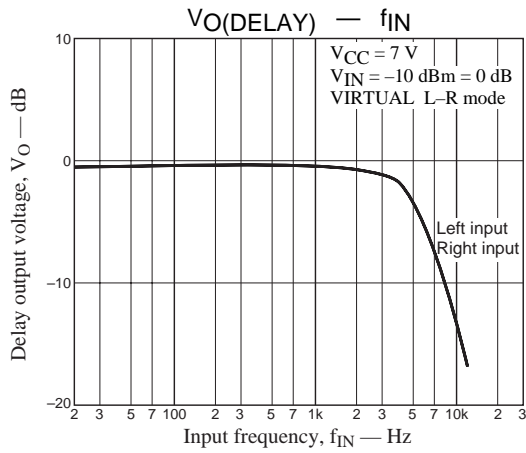

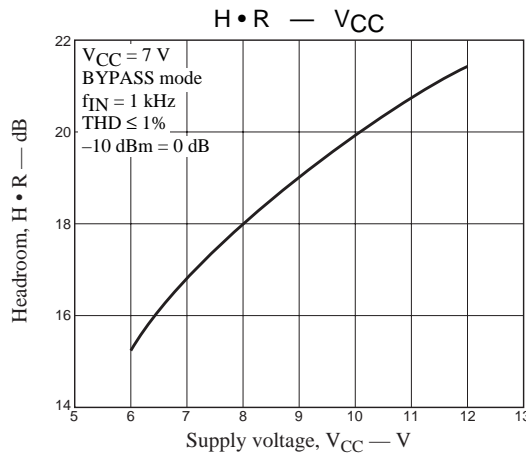
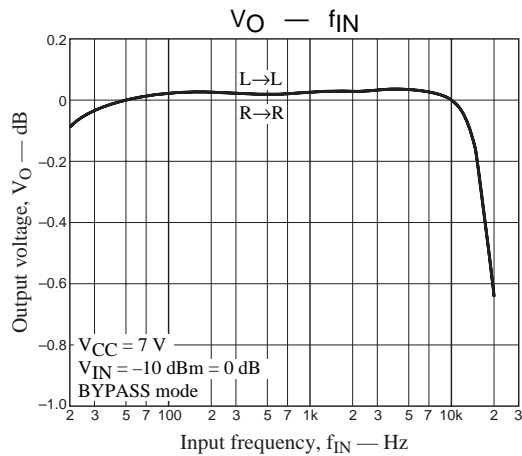
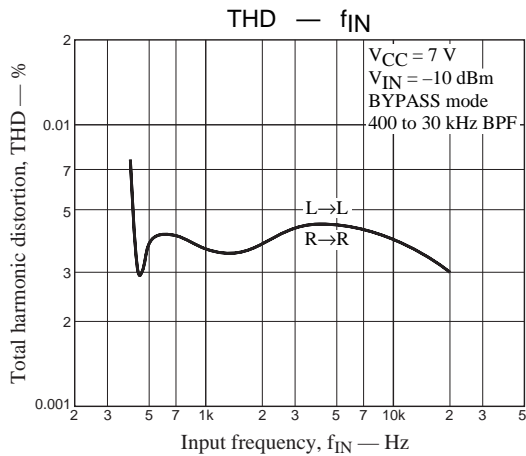

- Specifications of any and all SANYO products described or contained herein stipulate the performance, characteristics, and functions of the described products in the independent state, and are not guarantees of the performance, characteristics, and functions of the described products as mounted in the customer's products or equipment. To verify symptoms and states that cannot be evaluated in an independent device, the customer should always evaluate and test devices mounted in the customer's products or equipment.
- SANYO Electric Co., Ltd. strives to supply high-quality high-reliability products. However, any and all semiconductor products fail with some probability. It is possible that these probabilistic failures could give rise to accidents or events that could endanger human lives, that could give rise to smoke or fire, or that could cause damage to other property. When designing equipment, adopt safety measures so that these kinds of accidents or events cannot occur. Such measures include but are not limited to protective circuits and error prevention circuits for safe design, redundant design, and structural design.
- In the event that any or all SANYO products (including technical data, services) described or contained herein are controlled under any of applicable local export control laws and regulations, such products must not be exported without obtaining the export license from the authorities concerned in accordance with the above law.
- No part of this publication may be reproduced or transmitted in any form or by any means, electronic or mechanical, including photocopying and recording, or any information storage or retrieval system, or otherwise, without the prior written permission of SANYO Electric Co., Ltd.
- Any and all information described or contained herein are subject to change without notice due to product/technology improvement, etc. When designing equipment, refer to the "Delivery Specification" for the SANYO product that you intend to use.
- Information (including circuit diagrams and circuit parameters) herein is for example only; it is not guaranteed for volume production. SANYO believes information herein is accurate and reliable, but no guarantees are made or implied regarding its use or any infringements of intellectual property rights or other rights of third parties.

This catalog provides information as of July, 1999. Specifications and information herein are subject to change without notice.