

Dual/Quad Over-The-Top Micropower Rail-to-Rail Input and Output Op Amps

FEATURES

- **Low Input Offset Voltage: 500 μ V Max**
- **Output Swings to 10mV Max from V⁻**
- **Rail-to-Rail Input and Output**
- **Micropower: 50 μ A/Amplifier Max**
- **MSOP Package**
- **Over-The-Top™ Input Common Mode Range Extends 44V Above V⁻, Independent of V⁺**
- **Specified on 3V, 5V and \pm 15V Supplies**
- **High Output Current: 20mA**
- **Output Drives 10,000pF with Output Compensation**
- **Reverse Battery Protection to 18V**
- **No Supply Sequencing Problems**
- **High Voltage Gain: 1500V/mV**
- **High CMRR: 98dB**
- **No Phase Reversal**
- **Gain Bandwidth Product: 200kHz**

APPLICATIONS

- **Battery- or Solar-Powered Systems**
 - Portable Instrumentation
 - Sensor Conditioning
- **Supply Current Sensing**
- **Battery Monitoring**
- **Micropower Active Filters**
- **4mA to 20mA Transmitters**

LT, LTC and LT are registered trademarks of Linear Technology Corporation. Over-The-Top is a trademark of Linear Technology Corporation.

DESCRIPTION

The LT[®]1490A/LT1491A are enhanced versions of the popular LT1490/LT1491 dual and quad op amps with improved input offset voltage (500 μ V max) and output voltage swing (10mV max from V⁻). They are recommended as replacements for the LT1490/LT1491 in all new designs. The LT1490A/LT1491A operate on all single and split supplies with a total voltage of 2V to 44V, drawing only 40 μ A of quiescent current per amplifier. These amplifiers are reverse supply protected; they draw virtually no current for reverse supply up to 18V. The input range of the LT1490A/LT1491A includes both supplies and the output swings to both supplies. Unlike most micropower op amps, the LT1490A/LT1491A can drive heavy loads; their rail-to-rail outputs drive 20mA. The LT1490A/LT1491A are unity-gain stable and drive all capacitive loads up to 10,000pF when optional 0.22 μ F and 150 Ω compensation is used.

The LT1490A/LT1491A have a unique input stage that operates and remains high impedance when above the positive supply. The inputs take 44V both differential and common mode even when operating on a 3V supply. Built-in resistors protect the inputs for faults below the negative supply up to 15V. There is no phase reversal of the output for inputs 15V below V⁻ or 44V above V⁻, independent of V⁺.

The LT1490A dual op amp is available in the 8-pin MSOP, PDIP and SO packages. The quad LT1491A is available in the 14-pin SO and PDIP packages.

TYPICAL APPLICATION

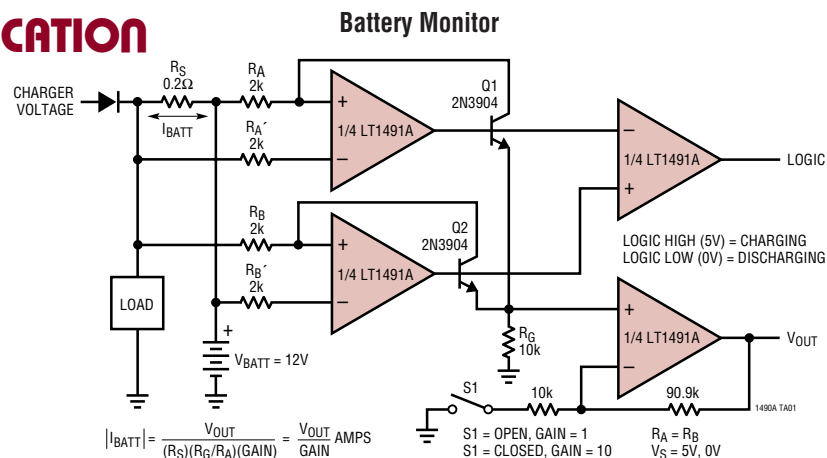

LT1490A/LT1491A

ABSOLUTE MAXIMUM RATINGS (Note 1)

Total Supply Voltage (V^+ to V^-)	44V	Specified Temperature Range (Note 4)	
Differential Input Voltage	44V	LT1490AC/LT1490AI	-40°C to 85°C
Input Current	$\pm 12\text{mA}$	LT1491AC/LT1491AI	-40°C to 85°C
Output Short-Circuit Duration (Note 2)	Continuous	LT1490AH/LT1491AH	-40°C to 125°C
Operating Temperature Range (Note 3)		Junction Temperature	150°C
LT1490AC/LT1491AC	-40°C to 85°C	Storage Temperature Range	-65°C to 150°C
LT1490AI/LT1491AI	-40°C to 85°C	Lead Temperature (Soldering, 10 sec)	300°C
LT1490AH/LT1491AH	-40°C to 125°C		

PACKAGE/ORDER INFORMATION

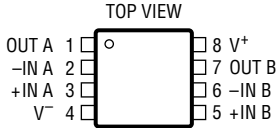
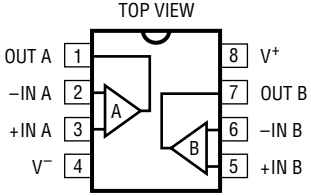
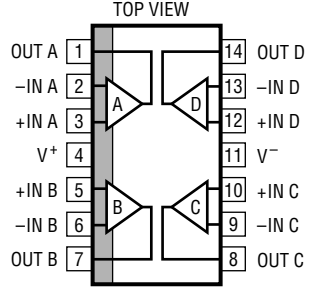
 <p>MS8 PACKAGE 8-LEAD PLASTIC MSOP $T_{JMAX} = 150^\circ\text{C}$, $\theta_{JA} = 250^\circ\text{C/W}$</p>		 <p>N8 PACKAGE 8-LEAD PDIP S8 PACKAGE 8-LEAD PLASTIC SO $T_{JMAX} = 150^\circ\text{C}$, $\theta_{JA} = 130^\circ\text{C/W}$ (N8) $T_{JMAX} = 150^\circ\text{C}$, $\theta_{JA} = 190^\circ\text{C/W}$ (S8)</p>		 <p>N PACKAGE 14-LEAD PDIP S PACKAGE 14-LEAD PLASTIC SO $T_{JMAX} = 150^\circ\text{C}$, $\theta_{JA} = 110^\circ\text{C/W}$ (N) $T_{JMAX} = 150^\circ\text{C}$, $\theta_{JA} = 150^\circ\text{C/W}$ (S)</p>	
ORDER PART NUMBER	MS8 PART MARKING	ORDER PART NUMBER	S8 PART MARKING	ORDER PART NUMBER	
LT1490ACMS8	LTNG	LT1490ACN8	1490A	LT1491ACN	LT1491AIS
LT1490AIMS8	LTPU	LT1490ACS8	1490AI	LT1491ACS	LT1491AHS
LT1490AHMS8	LTRK	LT1490AIN8	1490AH	LT1491AIN	
		LT1490AIS8			
		LT1490AHS8			

Consult factory for Military grade parts.

ELECTRICAL CHARACTERISTICS

The ● denotes specifications which apply over the full operating temperature range of $-40^\circ\text{C} \leq T_A \leq 85^\circ\text{C}$, otherwise specifications are at $T_A = 25^\circ\text{C}$. $V_S = 3\text{V}$, 0V ; $V_S = 5\text{V}$, 0V ; $V_{CM} = V_{OUT} = \text{half supply}$ unless otherwise noted. (Note 4)

SYMBOL	PARAMETER	CONDITIONS	LT1490AC/LT1491AC LT1490AI/LT1491AI			UNITS
			MIN	TYP	MAX	
V_{OS}	Input Offset Voltage (Note 5)	LT1490A N, S Packages		110	500	μV
		$0^\circ\text{C} \leq T_A \leq 70^\circ\text{C}$	●		700	μV
		$-40^\circ\text{C} \leq T_A \leq 85^\circ\text{C}$	●		800	μV
	Input Offset Voltage Drift (Note 9)	LT1490A MS8 Package, LT1491A N, S Packages		220	1000	μV
		$0^\circ\text{C} \leq T_A \leq 70^\circ\text{C}$	●		1200	μV
		$-40^\circ\text{C} \leq T_A \leq 85^\circ\text{C}$	●		1400	μV
		$-40^\circ\text{C} \leq T_A \leq 85^\circ\text{C}$	●	2	4	$\mu\text{V}/^\circ\text{C}$

ELECTRICAL CHARACTERISTICS The ● denotes specifications which apply over the full operating temperature range of $-40^{\circ}\text{C} \leq T_A \leq 85^{\circ}\text{C}$, otherwise specifications are at $T_A = 25^{\circ}\text{C}$. $V_S = 3\text{V}, 0\text{V}$; $V_S = 5\text{V}, 0\text{V}$; $V_{\text{CM}} = V_{\text{OUT}} = \text{half supply}$ unless otherwise noted. (Note 4)

SYMBOL	PARAMETER	CONDITIONS	LT1490AC/LT1491AC LT1490AI/LT1491AI			UNITS
			MIN	TYP	MAX	
I_{OS}	Input Offset Current	$V_{\text{CM}} = 44\text{V}$ (Note 6)	●	0.2	0.8	nA μA
I_{B}	Input Bias Current	$V_{\text{CM}} = 44\text{V}$ (Note 6) $V_S = 0\text{V}$	●	1	8	nA
			●	3	10	μA
			●	0.3		nA
	Input Bias Current Drift	$-40^{\circ}\text{C} \leq T_A \leq 85^{\circ}\text{C}$	●	2		$\text{pA}/^{\circ}\text{C}$
	Input Noise Voltage	0.1Hz to 10Hz		1		$\mu\text{V}_{\text{P-P}}$
e_{n}	Input Noise Voltage Density	$f = 1\text{kHz}$		50		$\text{nV}/\sqrt{\text{Hz}}$
i_{n}	Input Noise Current Density	$f = 1\text{kHz}$		0.015		$\text{pA}/\sqrt{\text{Hz}}$
R_{IN}	Input Resistance	Differential Common Mode, $V_{\text{CM}} = 0\text{V}$ to 44V		6	17	$\text{M}\Omega$
				4	11	$\text{M}\Omega$
C_{IN}	Input Capacitance			4.6		pF
	Input Voltage Range		●	0	44	V
CMRR	Common Mode Rejection Ratio (Note 6)	$V_{\text{CM}} = 0\text{V}$ to $V_{\text{CC}} - 1\text{V}$ $V_{\text{CM}} = 0\text{V}$ to 44V	●	84	98	dB
			●	80	98	dB
A_{VOL}	Large-Signal Voltage Gain	$V_S = 3\text{V}, V_O = 500\text{mV}$ to $2.5\text{V}, R_L = 10\text{k}$ $0^{\circ}\text{C} \leq T_A \leq 70^{\circ}\text{C}$ $-40^{\circ}\text{C} \leq T_A \leq 85^{\circ}\text{C}$	●	200	1500	V/mV
			●	133		V/mV
			●	100		V/mV
		$V_S = 5\text{V}, V_O = 500\text{mV}$ to $4.5\text{V}, R_L = 10\text{k}$ $0^{\circ}\text{C} \leq T_A \leq 70^{\circ}\text{C}$ $-40^{\circ}\text{C} \leq T_A \leq 85^{\circ}\text{C}$	●	400	1500	V/mV
			●	250		V/mV
			●	200		V/mV
V_{OL}	Output Voltage Swing Low	$V_S = 3\text{V}$, No Load $V_S = 3\text{V}, I_{\text{SINK}} = 5\text{mA}$	●	3	10	mV
			●	250	450	mV
		$V_S = 5\text{V}$, No Load $V_S = 5\text{V}, I_{\text{SINK}} = 5\text{mA}$ $V_S = 5\text{V}, I_{\text{SINK}} = 10\text{mA}$	●	3	10	mV
			●	250	500	mV
			●	330	500	mV
			●			mV
V_{OH}	Output Voltage Swing High	$V_S = 3\text{V}$, No Load $V_S = 3\text{V}, I_{\text{SOURCE}} = 5\text{mA}$	●	2.95	2.978	V
			●	2.55	2.6	V
		$V_S = 5\text{V}$, No Load $V_S = 5\text{V}, I_{\text{SOURCE}} = 10\text{mA}$	●	4.95	4.978	V
			●	4.30	4.6	V
			●			V
			●			V
I_{SC}	Short-Circuit Current (Note 2)	$V_S = 3\text{V}$, Short to GND $V_S = 3\text{V}$, Short to V_{CC}		10	15	mA
				10	30	mA
		$V_S = 5\text{V}$, Short to GND $V_S = 5\text{V}$, Short to V_{CC}		15	25	mA
				15	30	mA
						mA
						mA
PSRR	Power Supply Rejection Ratio	$V_S = 2.5\text{V}$ to $12.5\text{V}, V_{\text{CM}} = V_O = 1\text{V}$	●	84	98	dB
			●		2	2.5
	Reverse Supply Voltage	$I_S = -100\mu\text{A}$ per Amplifier	●	18	27	V
I_S	Supply Current per Amplifier (Note 7)		●	40	50 55	μA μA
GBW	Gain Bandwidth Product (Note 6)	$f = 1\text{kHz}$ $0^{\circ}\text{C} \leq T_A \leq 70^{\circ}\text{C}$ $-40^{\circ}\text{C} \leq T_A \leq 85^{\circ}\text{C}$	●	110	180	kHz
			●	100		kHz
			●	90		kHz
SR	Slew Rate (Note 8)	$A_V = -1, R_L = \infty$ $0^{\circ}\text{C} \leq T_A \leq 70^{\circ}\text{C}$ $-40^{\circ}\text{C} \leq T_A \leq 85^{\circ}\text{C}$	●	0.035	0.06	$\text{V}/\mu\text{s}$
			●	0.031		$\text{V}/\mu\text{s}$
			●	0.030		$\text{V}/\mu\text{s}$

LT1490A/LT1491A

ELECTRICAL CHARACTERISTICS The ● denotes specifications which apply over the full operating temperature range of $-40^{\circ}\text{C} \leq T_A \leq 85^{\circ}\text{C}$, otherwise specifications are at $T_A = 25^{\circ}\text{C}$. $V_S = \pm 15\text{V}$; $V_{CM} = 0\text{V}$, $V_{OUT} = 0\text{V}$ unless otherwise noted. (Note 4)

SYMBOL	PARAMETER	CONDITIONS	LT1490AC/LT1491AC LT1490AI/LT1491AI			UNITS
			MIN	TYP	MAX	
V_{OS}	Input Offset Voltage (Note 5)	LT1490A N, S Packages $0^{\circ}\text{C} \leq T_A \leq 70^{\circ}\text{C}$ $-40^{\circ}\text{C} \leq T_A \leq 85^{\circ}\text{C}$	●	150	700	μV
			●		950	μV
		LT1490A MS8 Package, LT1491A N, S Packages $0^{\circ}\text{C} \leq T_A \leq 70^{\circ}\text{C}$ $-40^{\circ}\text{C} \leq T_A \leq 85^{\circ}\text{C}$	●	250	1200	μV
			●		1350	μV
		●		1500	μV	
	Input Offset Voltage Drift (Note 9)	$-40^{\circ}\text{C} \leq T_A \leq 85^{\circ}\text{C}$	●	2	6	$\mu\text{V}/^{\circ}\text{C}$
I_{OS}	Input Offset Current		●	0.2	0.8	nA
I_B	Input Bias Current		●	1	8	nA
	Input Bias Current Drift	$-40^{\circ}\text{C} \leq T_A \leq 85^{\circ}\text{C}$	●	5		$\text{pA}/^{\circ}\text{C}$
	Input Noise Voltage	0.1Hz to 10Hz		1		μV_{P-P}
e_n	Input Noise Voltage Density	$f = 1\text{kHz}$		50		$\text{nV}/\sqrt{\text{Hz}}$
i_n	Input Noise Current Density	$f = 1\text{kHz}$		0.015		$\text{pA}/\sqrt{\text{Hz}}$
R_{IN}	Input Resistance	Differential Common Mode, $V_{CM} = -15\text{V}$ to 14V		6	17	$\text{M}\Omega$
					15000	$\text{M}\Omega$
C_{IN}	Input Capacitance			4.6		pF
	Input Voltage Range		●	-15	29	V
CMRR	Common Mode Rejection Ratio	$V_{CM} = -15\text{V}$ to 29V	●	80	98	dB
A_{VOL}	Large-Signal Voltage Gain	$V_O = \pm 14\text{V}$, $R_L = 10\text{k}$ $0^{\circ}\text{C} \leq T_A \leq 70^{\circ}\text{C}$ $-40^{\circ}\text{C} \leq T_A \leq 85^{\circ}\text{C}$	●	100	250	V/mV
			●	75		V/mV
			●	50		V/mV
V_O	Output Voltage Swing	No Load $I_{OUT} = \pm 5\text{mA}$ $I_{OUT} = \pm 10\text{mA}$	●	± 14.9	± 14.978	V
			●	± 14.5	± 14.750	V
			●	± 14.5	± 14.670	V
I_{SC}	Short-Circuit Current (Note 2)	Short to GND $0^{\circ}\text{C} \leq T_A \leq 70^{\circ}\text{C}$ $-40^{\circ}\text{C} \leq T_A \leq 85^{\circ}\text{C}$	●	± 20	± 25	mA
			●	± 15		mA
			●	± 10		mA
PSRR	Power Supply Rejection Ratio	$V_S = \pm 1.25\text{V}$ to $\pm 22\text{V}$	●	88	98	dB
I_S	Supply Current per Amplifier		●	50	70	μA
					85	μA
GBW	Gain Bandwidth Product	$f = 1\text{kHz}$ $0^{\circ}\text{C} \leq T_A \leq 70^{\circ}\text{C}$ $-40^{\circ}\text{C} \leq T_A \leq 85^{\circ}\text{C}$	●	125	200	kHz
			●	110		kHz
			●	100		kHz
SR	Slew Rate	$A_V = -1$, $R_L = \infty$, $V_O = \pm 10\text{V}$, Measure at $V_O = \pm 5\text{V}$ $0^{\circ}\text{C} \leq T_A \leq 70^{\circ}\text{C}$ $-40^{\circ}\text{C} \leq T_A \leq 85^{\circ}\text{C}$	●	0.0375	0.07	$\text{V}/\mu\text{s}$
			●	0.0330		$\text{V}/\mu\text{s}$
			●	0.0300		$\text{V}/\mu\text{s}$

ELECTRICAL CHARACTERISTICS The ● denotes specifications which apply over the full operating temperature range of $-40^{\circ}\text{C} \leq T_A \leq 125^{\circ}\text{C}$. $V_S = 3\text{V}, 0\text{V}$; $V_S = 5\text{V}, 0\text{V}$; $V_{\text{CM}} = V_{\text{OUT}} = \text{half supply unless otherwise noted. (Note 4)}$

SYMBOL	PARAMETER	CONDITIONS	LT1490AH/LT1491AH			UNITS
			MIN	TYP	MAX	
V_{OS}	Input Offset Voltage (Note 5)	LT1490AHS8	●	110	500 2500	μV μV
		LT1490AHMS8, LT1491AHS	●	220	1000 3000	μV μV
	Input Offset Voltage Drift (Note 9)		●	3	6	$\mu\text{V}/^{\circ}\text{C}$
I_{OS}	Input Offset Current	$V_{\text{CM}} = 44\text{V}$ (Note 6)	●		2	nA
			●		1.5	μA
I_{B}	Input Bias Current	$V_{\text{CM}} = 44\text{V}$ (Note 6)	●		20	nA
			●		15	μA
	Input Voltage Range		●	0.3	44	V
CMRR	Common Mode Rejection Ratio (Note 6)	$V_{\text{CM}} = 0.3\text{V to }V_{\text{CC}} - 1\text{V}$	●	60		dB
		$V_{\text{CM}} = 0.3\text{V to }44\text{V}$	●	74		dB
A_{VOL}	Large-Signal Voltage Gain	$V_S = 3\text{V}, V_O = 500\text{mV to }2.5\text{V}, R_L = 10\text{k}$	●	200 25	1500	V/mV V/MV
		$V_S = 5\text{V}, V_O = 500\text{mV to }4.5\text{V}, R_L = 10\text{k}$	●	400 50	1500	V/mV V/mV
V_{OL}	Output Voltage Swing Low	$V_S = 3\text{V}, \text{No Load}$	●		15	mV
		$V_S = 3\text{V}, I_{\text{SINK}} = 2.5\text{mA}$	●		450	mV
		$V_S = 5\text{V}, \text{No Load}$	●		15	mV
		$V_S = 5\text{V}, I_{\text{SINK}} = 2.5\text{mA}$	●		500	mV
V_{OH}	Output Voltage Swing High	$V_S = 3\text{V}, \text{No Load}$	●	2.925		V
		$V_S = 3\text{V}, I_{\text{SOURCE}} = 5\text{mA}$	●	2.350		V
		$V_S = 5\text{V}, \text{No Load}$	●	4.925		V
		$V_S = 5\text{V}, I_{\text{SOURCE}} = 10\text{mA}$	●	4.100		V
PSRR	Power Supply Rejection Ratio	$V_S = 2.5\text{V to }12.5\text{V}, V_{\text{CM}} = V_O = 1\text{V}$	●	80		dB
		Minimum Operating Supply Voltage	●		2.5	V
		Reverse Supply Voltage	●	18		V
I_{S}	Supply Current per Amplifier (Note 7)		●	40	50 70	μA μA
			●	110 60	180	kHz kHz
SR	Slew Rate (Note 8)	$A_V = -1, R_L = \infty$	●	0.035	0.06	V/ μs
			●	0.015		V/ μs

ELECTRICAL CHARACTERISTICS

The ● denotes specifications which apply over the full operating temperature range of $-40^{\circ}\text{C} \leq T_A \leq 125^{\circ}\text{C}$. $V_S = \pm 15\text{V}$, $V_{\text{CM}} = 0\text{V}$, $V_{\text{OUT}} = 0\text{V}$ unless otherwise noted. (Note 4)

SYMBOL	PARAMETER	CONDITIONS	LT1490AH/LT1491AH			UNITS
			MIN	TYP	MAX	
V_{OS}	Input Offset Voltage (Note 5)	LT1490AHS8		150	700	μV
			●		2700	μV
		LT1490AHMS8, LT1491AHS		250	1200	μV
			●		3200	μV
	Input Offset Voltage Drift (Note 9)		●	3	7	$\mu\text{V}/^{\circ}\text{C}$
I_{OS}	Input Offset Current		●		2	nA
I_{B}	Input Bias Current		●		20	nA
	Input Voltage Range		●	-14.7	29	V
CMRR	Common Mode Rejection Ratio	$V_{\text{CM}} = -14.7\text{V}$ to 29V	●	72		dB
A_{VOL}	Large-Signal Voltage Gain	$V_0 = \pm 14\text{V}$, $R_L = 10\text{k}$	●	100	250	V/mV
			●	4		V/mV
V_0	Output Voltage Swing	No Load	●	± 14.8		mV
		$I_{\text{OUT}} = \pm 2.5\text{mA}$	●	± 14.3		mV
PSRR	Power Supply Rejection Ratio	$V_S = \pm 1.25\text{V}$ to $\pm 22\text{V}$	●	84		dB
I_S	Supply Current per Amplifier		●	50	70	μA
					95	μA
GBW	Gain Bandwidth Product	$f = 1\text{kHz}$	●	125	200	kHz
			●	75		kHz
SR	Slew Rate	$A_V = -1$, $R_L = \infty$	●	0.0375	0.07	V/ μs
			●	0.02		V/ μs

Note 1: Absolute Maximum Ratings are those values beyond which the life of the device may be impaired.

Note 2: A heat sink may be required to keep the junction temperature below absolute maximum. This depends on the power supply voltage and how many amplifiers are shorted.

Note 3: The LT1490AC/LT1491AC and LT1490AI/LT1491AI are guaranteed functional over the operating temperature range of -40°C to 85°C . The LT1490AH/LT1491AH are guaranteed functional over the operating temperature range of -40°C to 125°C .

Note 4: The LT1490AC/LT1491AC are guaranteed to meet specified performance from 0°C to 70°C . The LT1490AC/LT1491AC are designed, characterized and expected to meet specified performance from -40°C to 85°C but are not tested or QA sampled at these temperatures. The LT1490AI/LT1491AI are guaranteed to meet specified performance from -40°C to 85°C . The LT1490AH/LT1491AH are guaranteed to meet specified performance from -40°C to 125°C .

Note 5: ESD (Electrostatic Discharge) sensitive device. Extensive use of ESD protection devices are used internal to the LT1490A/LT1491A. However, high electrostatic discharge can damage or degrade the device. Use proper ESD handling precautions.

Note 6: $V_S = 5\text{V}$ limits are guaranteed by correlation to $V_S = 3\text{V}$ and $V_S = \pm 15\text{V}$ tests.

Note 7: $V_S = 3\text{V}$ limits are guaranteed by correlation to $V_S = 5\text{V}$ and $V_S = \pm 15\text{V}$ tests.

Note 8: Guaranteed by correlation to slew rate at $V_S = \pm 15\text{V}$ and GBW at $V_S = 3\text{V}$ and $V_S = \pm 15\text{V}$ tests.

Note 9: This parameter is not 100% tested.

TYPICAL PERFORMANCE CHARACTERISTICS

Supply Current vs Supply Voltage

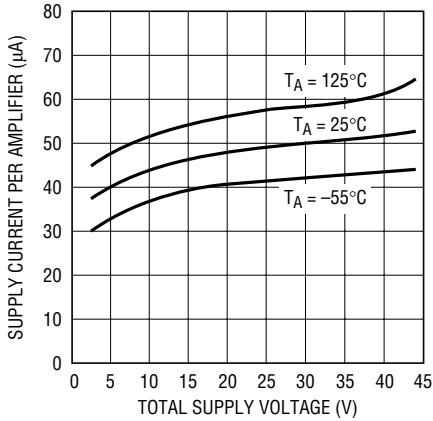

1490A G01

Minimum Supply Voltage

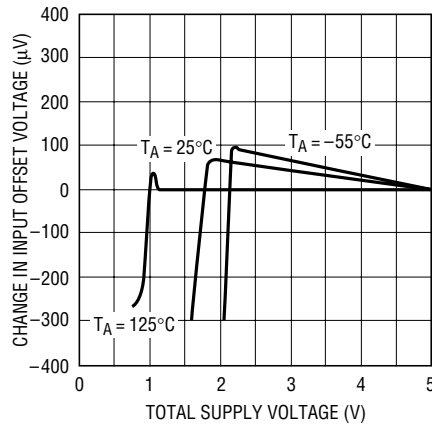

1490A G02

Input Bias Current vs Common Mode Voltage

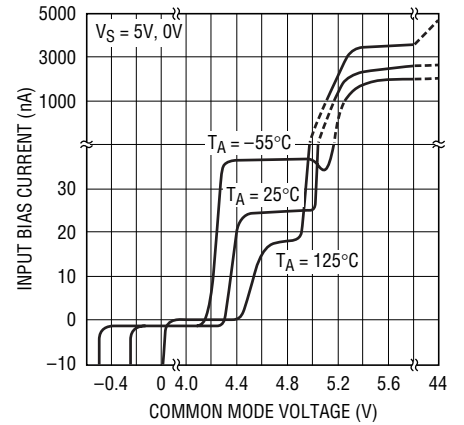

1490A G03

Output Saturation Voltage vs Load Current (Output High)

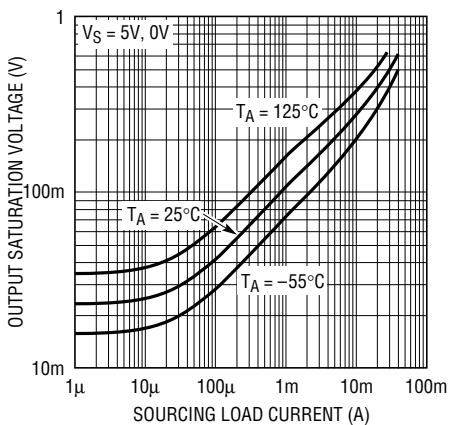

1490A G04

Output Saturation Voltage vs Load Current (Output Low)

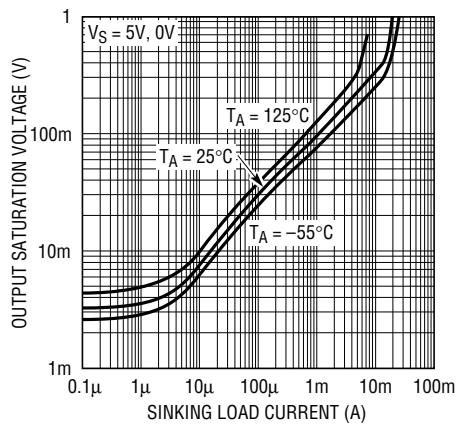

1490A G05

Output Saturation Voltage vs Input Overdrive

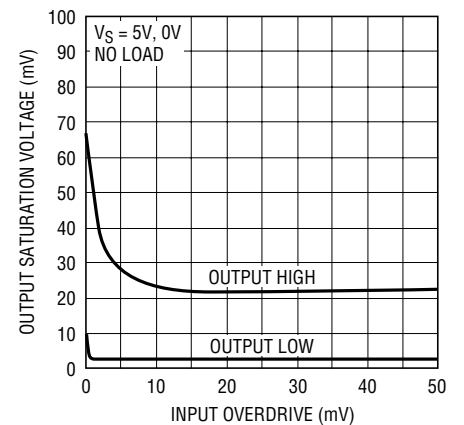

1490A G06

0.1Hz to 10Hz Noise Voltage

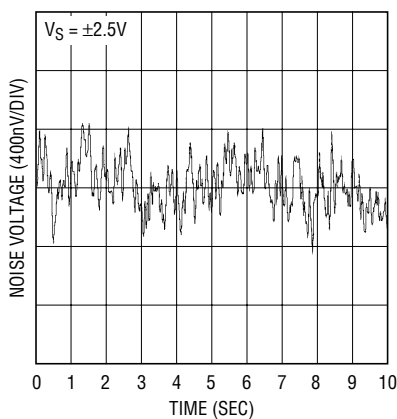

1490A G07

Noise Voltage Density vs Frequency

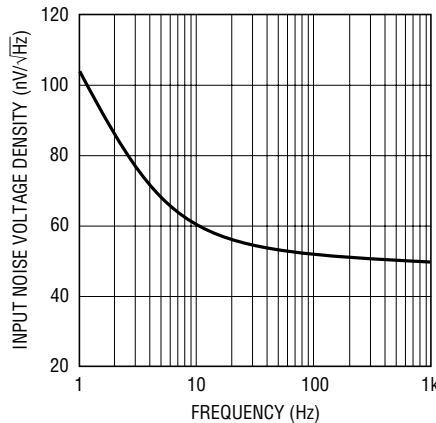

1490A G08

Input Noise Current vs Frequency

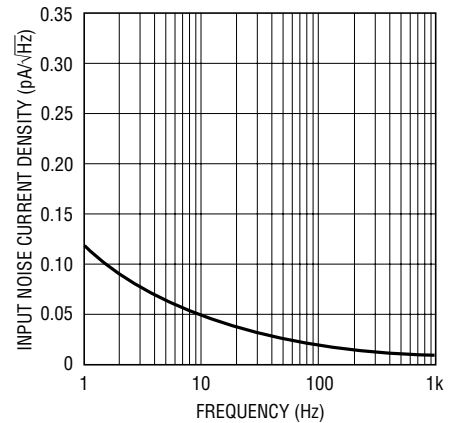

1490A G09

TYPICAL PERFORMANCE CHARACTERISTICS

Gain and Phase Shift vs Frequency

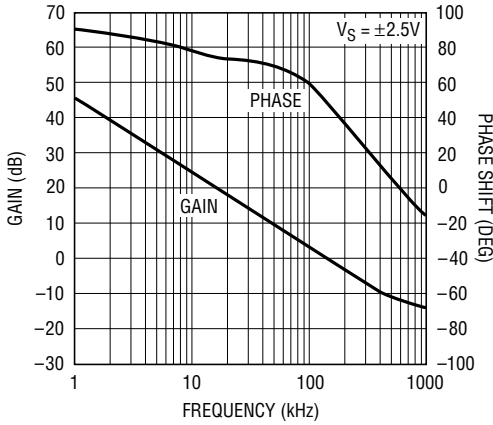

1490A G10

Gain Bandwidth Product vs Temperature

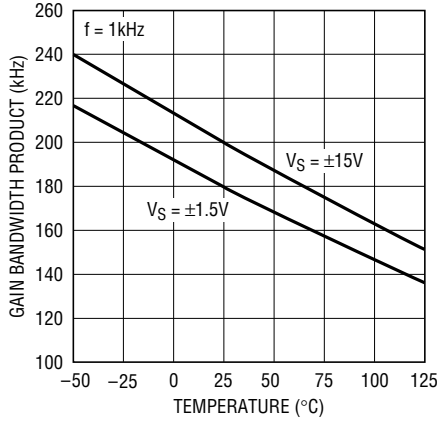

1490A G11

Slew Rate vs Temperature

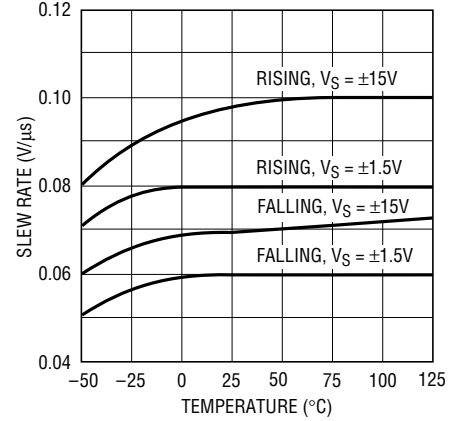

1490A G12

Gain Bandwidth Product and Phase Margin vs Supply Voltage

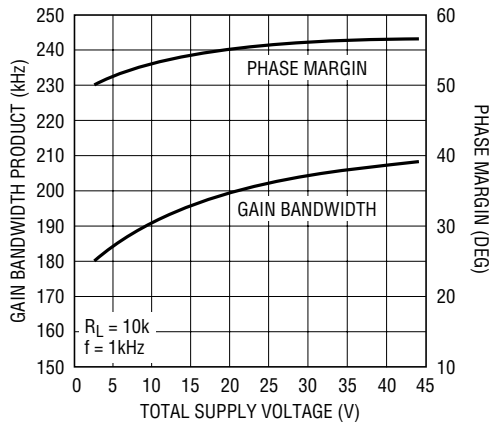

1490A G13

CMRR vs Frequency

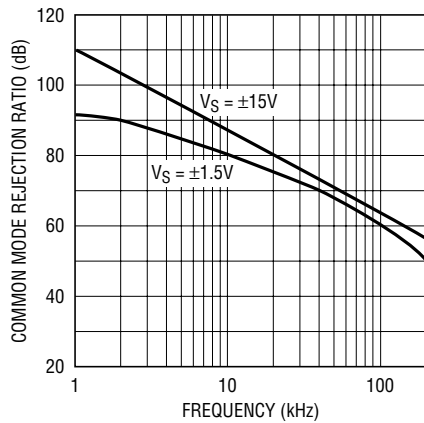

1490A G14

PSRR vs Frequency

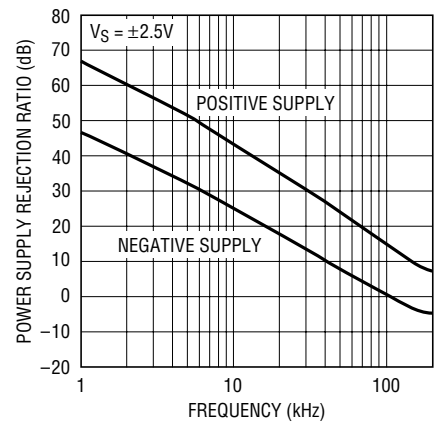

1490A G15

Gain Bandwidth Product and Phase Margin vs Load Resistance

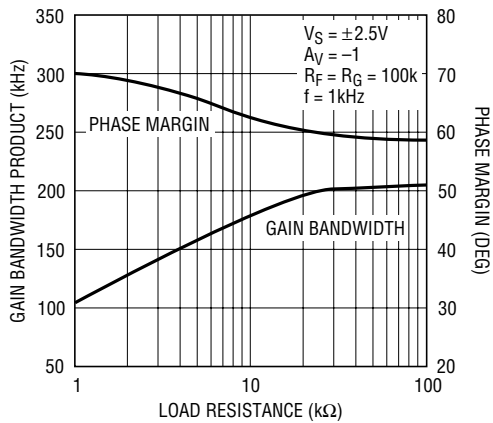

1490A G16

Channel Separation vs Frequency

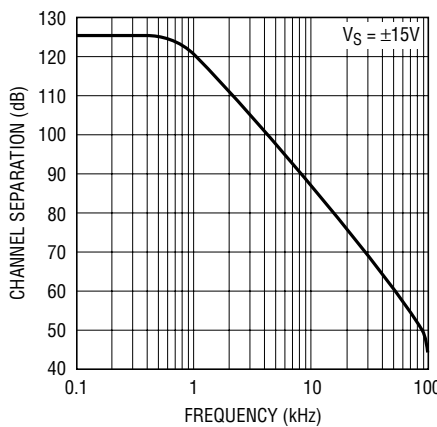

1490A G17

Output Impedance vs Frequency

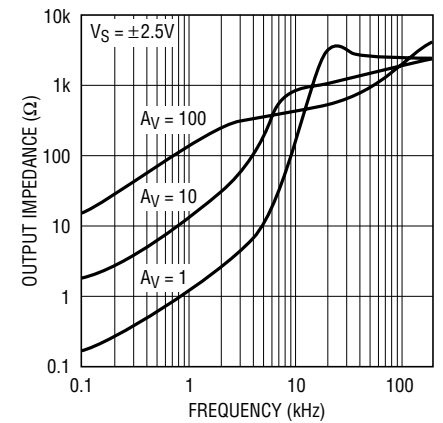

1490A G18

TYPICAL PERFORMANCE CHARACTERISTICS

Undistorted Output Swing vs Frequency

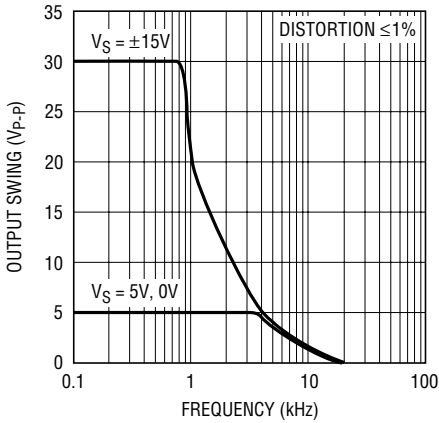

1490A G19

Settling Time to 0.1% vs Output Step

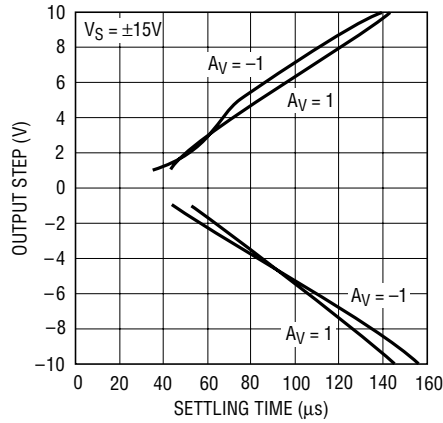

1490A F20

Capacitive Load Handling, Overshoot vs Capacitive Load

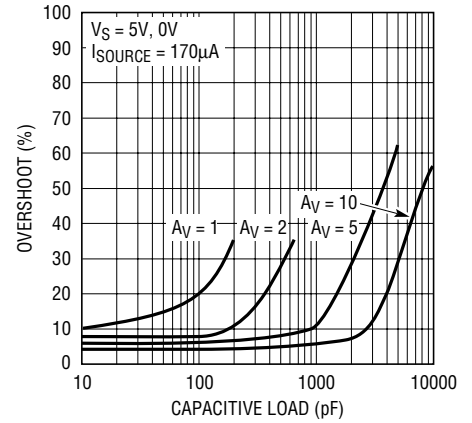

1490A G21

Total Harmonic Distortion + Noise vs Frequency

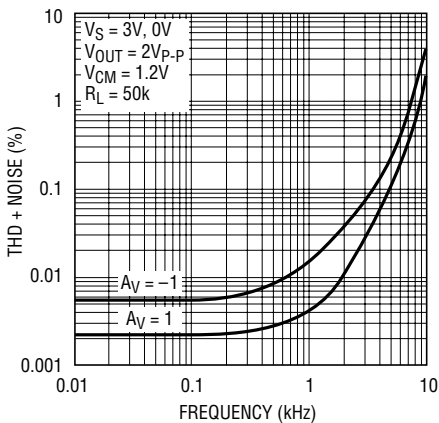

1490A G22

Total Harmonic Distortion + Noise vs Load Resistance

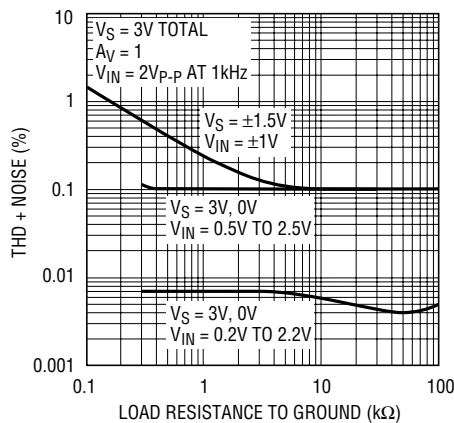

1490A G23

Total Harmonic Distortion + Noise vs Output Voltage

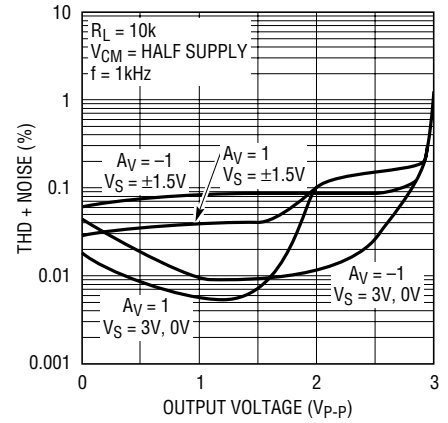

1490A G24

Open-Loop Gain

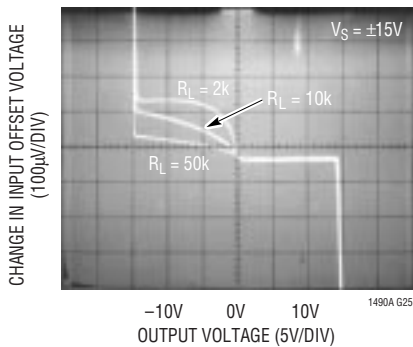

1490A G25

Large-Signal Response

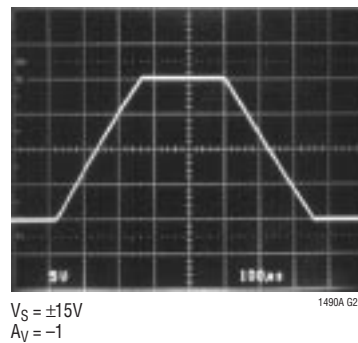

1490A G26

Small-Signal Response

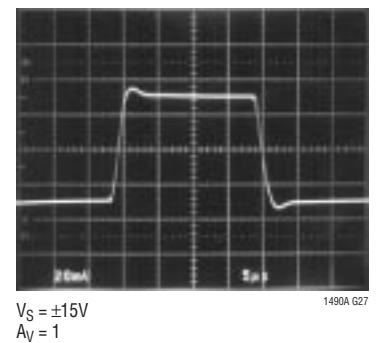

1490A G27

APPLICATIONS INFORMATION

Supply Voltage

The positive supply pin of the LT1490A/LT1491A should be bypassed with a small capacitor (about $0.01\mu\text{F}$) within an inch of the pin. When driving heavy loads an additional $4.7\mu\text{F}$ electrolytic capacitor should be used. When using split supplies, the same is true for the negative supply pin.

The LT1490A/LT1491A are protected against reverse battery voltages up to 18V. In the event a reverse battery condition occurs, the supply current is less than 1nA.

The LT1490A/LT1491A can be shut down by removing V^+ . In this condition the input bias current is typically less than 0.5nA, even if the inputs are 44V above the negative supply.

When operating the LT1490A/LT1491A on total supplies of 20V or more, the supply must not rise to its final voltage in less than $1\mu\text{s}$. This is especially true if low ESR bypass capacitors are used. A series RLC circuit is formed from the supply lead inductance and the bypass capacitor. A resistance of 7.5Ω in the supply or in the bypass capacitor will dampen the tuned circuit enough to limit the rise time.

Inputs

The LT1490A/LT1491A have two input stages, NPN and PNP (see the Simplified Schematic), resulting in three distinct operating regions as shown in the Input Bias Current vs Common Mode typical performance curve.

For input voltages about 0.8V or more below V^+ , the PNP input stage is active and the input bias current is typically -1nA . When the input voltage is about 0.5V or less from V^+ , the NPN input stage is operating and the input bias current is typically 25nA. Increases in temperature will cause the voltage at which operation switches from the PNP stage to the NPN stage to move towards V^+ . The input offset voltage of the NPN stage is untrimmed and is typically $600\mu\text{V}$.

A Schottky diode in the collector of each NPN transistor of the NPN input stage allows the LT1490A/LT1491A to operate with either or both of their inputs above V^+ . At about 0.3V above V^+ the NPN input transistor is fully saturated and the input bias current is typically $3\mu\text{A}$ at room temperature. The input offset voltage is typically $700\mu\text{V}$ when

operating above V^+ . The LT1490A/LT1491A will operate with their inputs 44V above V^- regardless of V^+ .

The inputs are protected against excursions as much as 15V below V^- by an internal 1k resistor in series with each input and a diode from the input to the negative supply. There is no output phase reversal for inputs up to 15V below V^- . There are no clamping diodes between the inputs and the maximum differential input voltage is 44V.

Output

The output voltage swing of the LT1490A/LT1491A is affected by input overdrive as shown in the typical performance curves.

The output of the LT1490A/LT1491A can be pulled up to 18V beyond V^+ with less than 1nA of leakage current, provided that V^+ is less than 0.5V.

The normally reverse-biased substrate diode from the output to V^- will cause unlimited currents to flow when the output is forced below V^- . If the current is transient and limited to 100mA, no damage will occur.

The LT1490A/LT1491A are internally compensated to drive at least 200pF of capacitance under any output loading conditions. A $0.22\mu\text{F}$ capacitor in series with a 150Ω resistor between the output and ground will compensate these amplifiers for larger capacitive loads, up to 10,000pF, at all output currents.

Distortion

There are two main contributors of distortion in op amps: output crossover distortion as the output transitions from sourcing to sinking current and distortion caused by nonlinear common mode rejection. Of course, if the op amp is operating inverting there is no common mode induced distortion. When the LT1490A/LT1491A switch between input stages there is significant nonlinearity in the CMRR. Lower load resistance increases the output crossover distortion, but has no effect on the input stage transition distortion. For lowest distortion the LT1490A/LT1491A should be operated single supply, with the output always sourcing current and with the input voltage swing between ground and $(V^+ - 0.8\text{V})$. See the Typical Performance Characteristics curves.

APPLICATIONS INFORMATION

Gain

The open-loop gain is almost independent of load when the output is sourcing current. This optimizes performance

in single supply applications where the load is returned to ground. The typical performance photo of Open-Loop Gain for various loads shows the details.

TYPICAL APPLICATIONS

Square Wave Oscillator

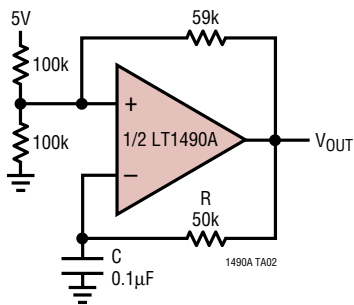

$$f = \frac{1}{2RC}$$

$V_{OUT} = 5V_{P-P}$ WITH 5V SUPPLY

$I_S = 200\mu A$

AT $V_S = 5V$, $R = 50k$, $C = 1nF$
OUTPUT IS 5kHz SLEW LIMITED TRIANGLE WAVE

Optional Output Compensation for Capacitive Loads Greater Than 200pF

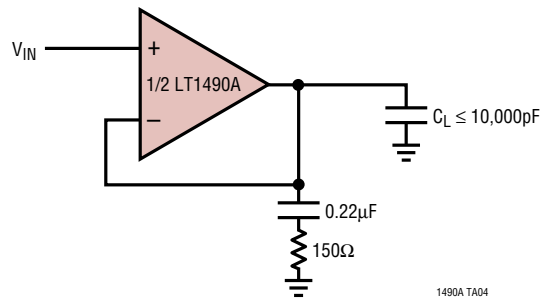

SIMPLIFIED SCHEMATIC

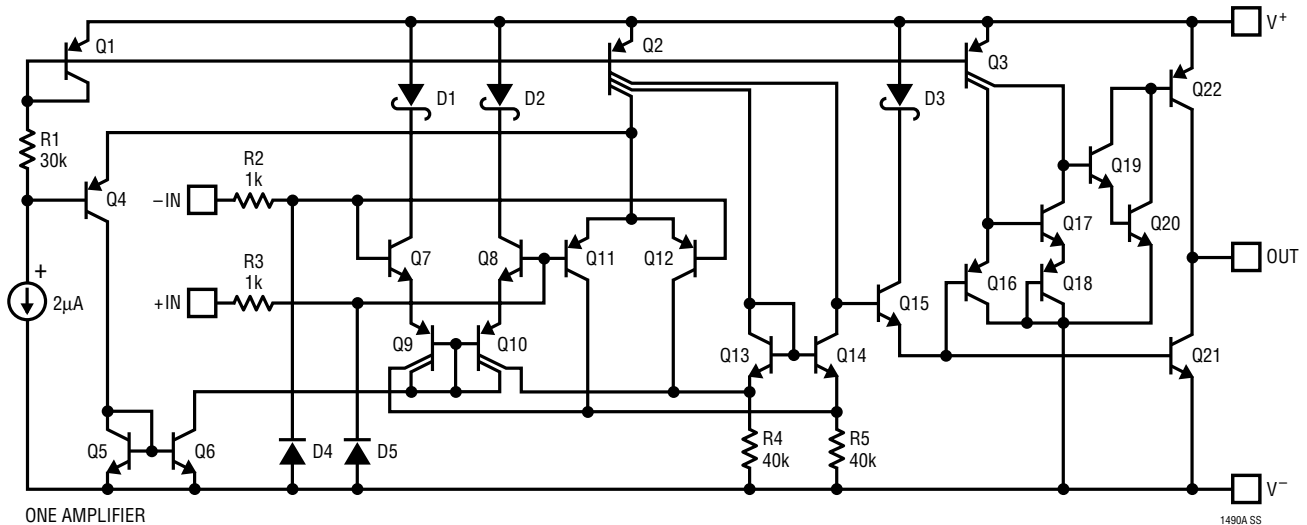

PACKAGE DESCRIPTION Dimensions in inches (millimeters) unless otherwise noted.

MS8 Package
8-Lead Plastic MSOP
 (LTC DWG # 05-08-1660)

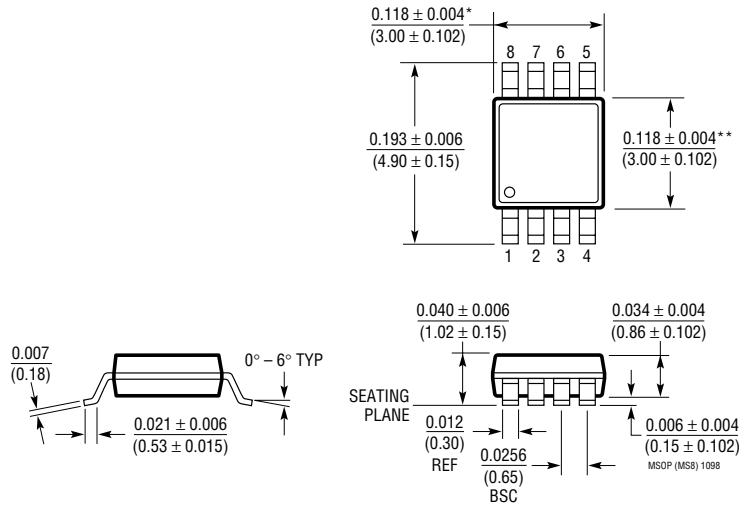

* DIMENSION DOES NOT INCLUDE MOLD FLASH, PROTRUSIONS OR GATE BURRS. MOLD FLASH, PROTRUSIONS OR GATE BURRS SHALL NOT EXCEED 0.006" (0.152mm) PER SIDE
 ** DIMENSION DOES NOT INCLUDE INTERLEAD FLASH OR PROTRUSIONS. INTERLEAD FLASH OR PROTRUSIONS SHALL NOT EXCEED 0.006" (0.152mm) PER SIDE

N8 Package
8-Lead PDIP (Narrow 0.300)
 (LTC DWG # 05-08-1510)

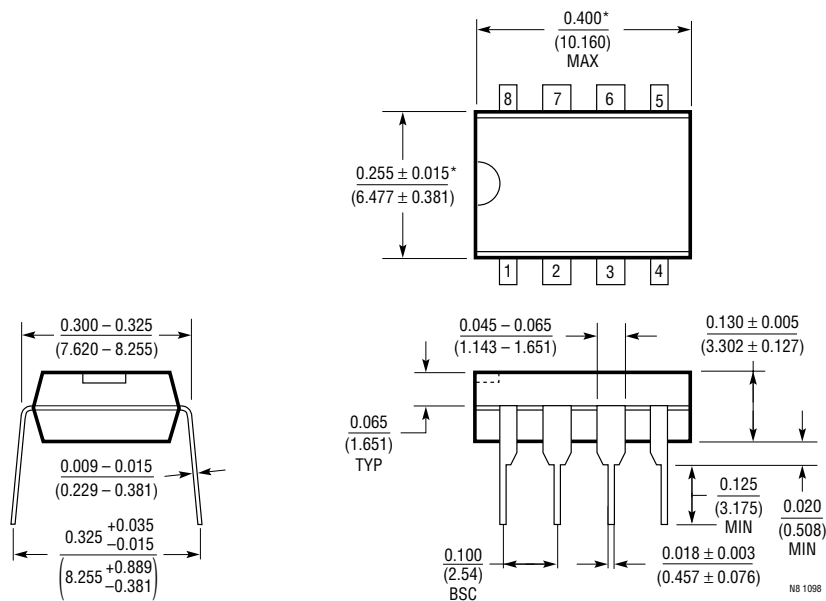

* THESE DIMENSIONS DO NOT INCLUDE MOLD FLASH OR PROTRUSIONS. MOLD FLASH OR PROTRUSIONS SHALL NOT EXCEED 0.010 INCH (0.254mm)

PACKAGE DESCRIPTION Dimensions in inches (millimeters) unless otherwise noted.

S8 Package
8-Lead Plastic Small Outline (Narrow 0.150)
 (LTC DWG # 05-08-1610)

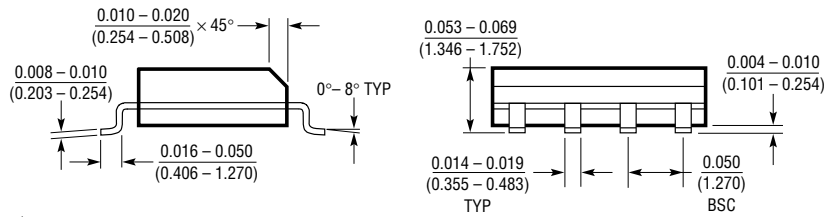
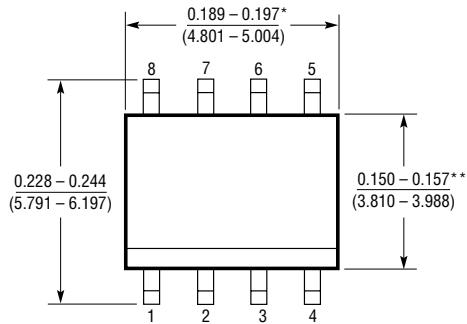

* DIMENSION DOES NOT INCLUDE MOLD FLASH. MOLD FLASH SHALL NOT EXCEED 0.006" (0.152mm) PER SIDE
 ** DIMENSION DOES NOT INCLUDE INTERLEAD FLASH. INTERLEAD FLASH SHALL NOT EXCEED 0.010" (0.254mm) PER SIDE

S08 1298

PACKAGE DESCRIPTION Dimensions in inches (millimeters) unless otherwise noted.

N Package
14-Lead PDIP (Narrow 0.300)
 (LTC DWG # 05-08-1510)

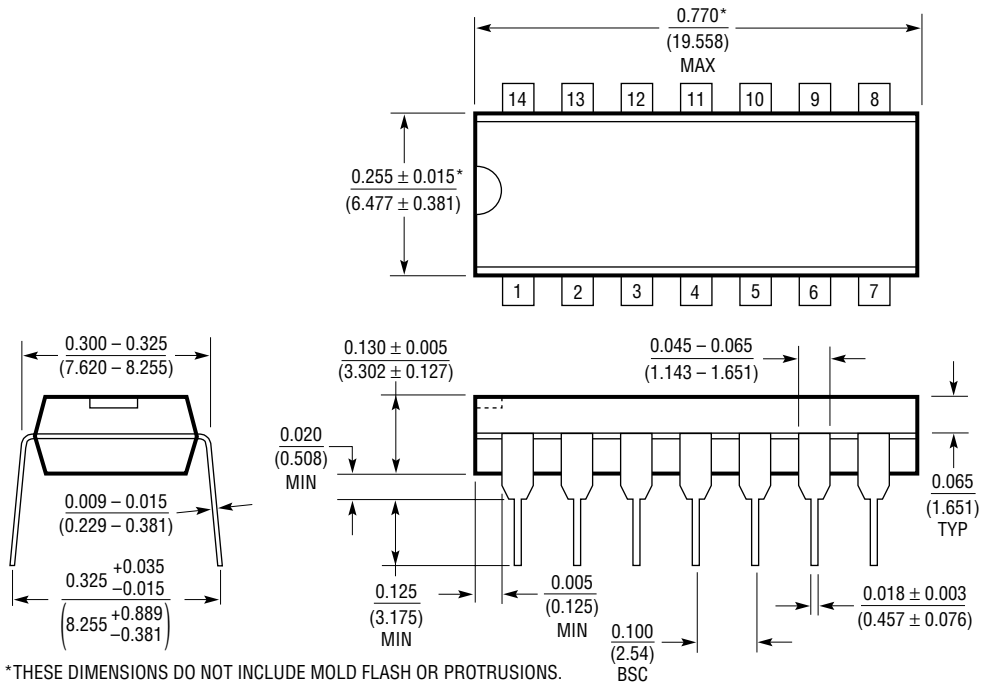

*THESE DIMENSIONS DO NOT INCLUDE MOLD FLASH OR PROTRUSIONS.
 MOLD FLASH OR PROTRUSIONS SHALL NOT EXCEED 0.010 INCH (0.254mm)

N14 1098

PACKAGE DESCRIPTION Dimensions in inches (millimeters) unless otherwise noted.

S Package
14-Lead Plastic Small Outline (Narrow 0.150)
 (LTC DWG # 05-08-1610)

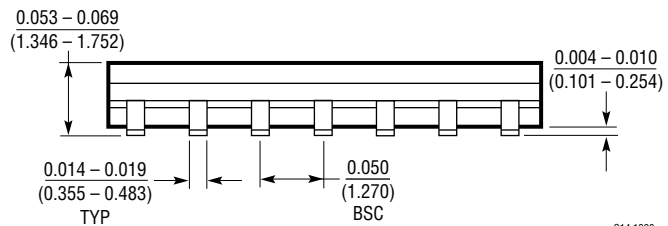
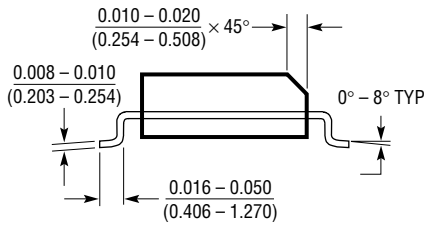
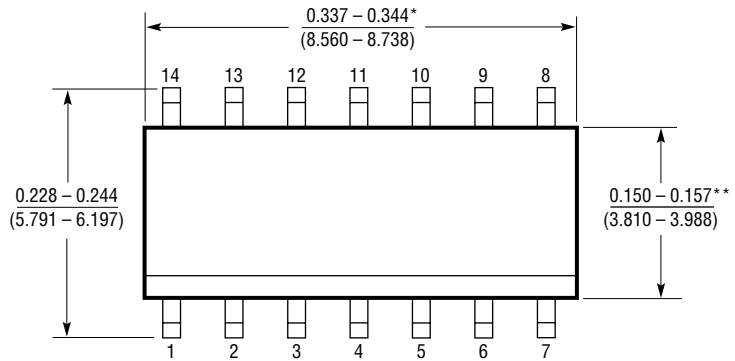

*DIMENSION DOES NOT INCLUDE MOLD FLASH. MOLD FLASH SHALL NOT EXCEED 0.006" (0.152mm) PER SIDE

**DIMENSION DOES NOT INCLUDE INTERLEAD FLASH. INTERLEAD FLASH SHALL NOT EXCEED 0.010" (0.254mm) PER SIDE

S14 1298

TYPICAL APPLICATION

Ring-Tone Generator

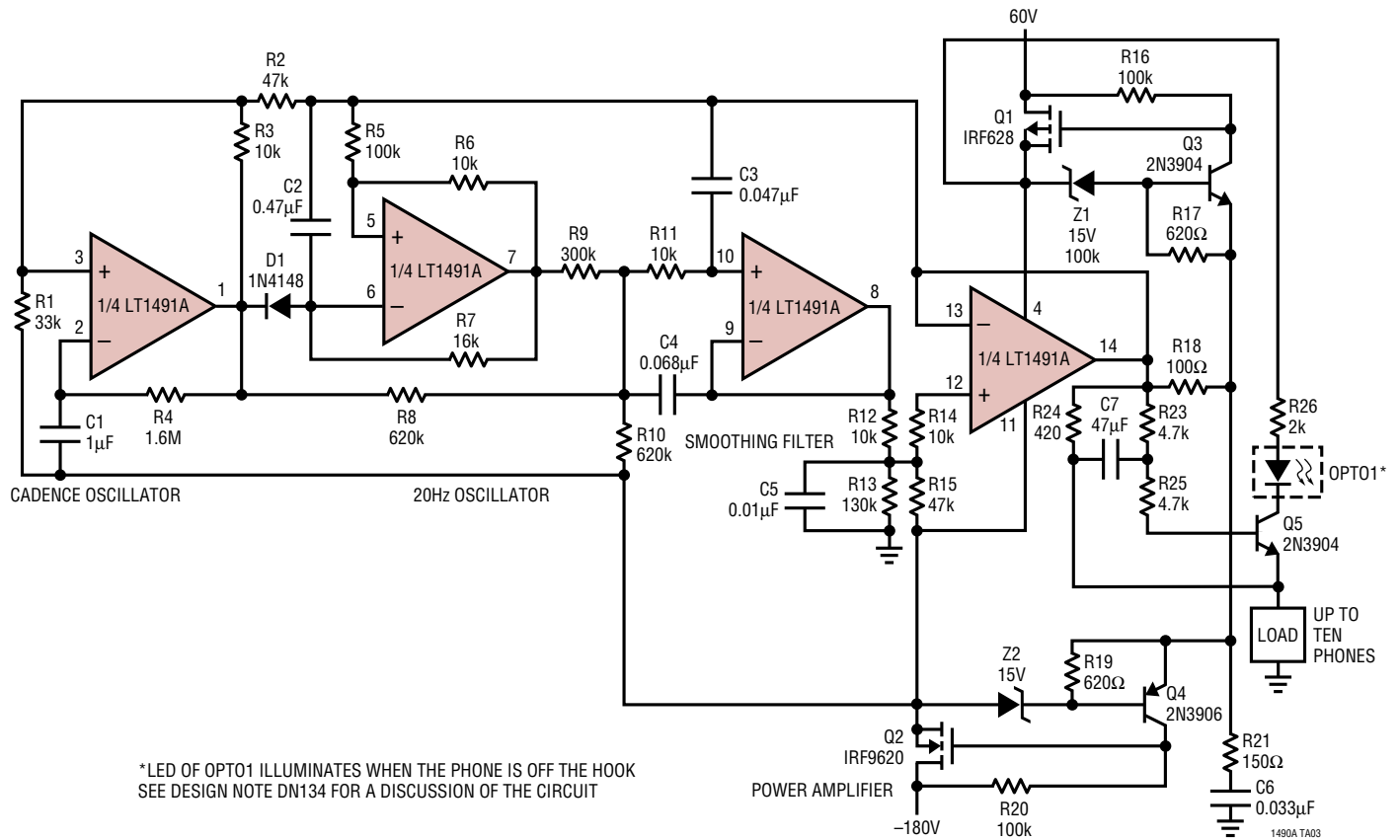

RELATED PARTS

PART NUMBER	DESCRIPTION	COMMENTS
LT1366/LT1367	Dual/Quad Precision, Rail-to-Rail Input and Output Op Amps	475μV $V_{OS(MAX)}$, 500V/mV $A_{VOL(MIN)}$, 400kHz GBW
LT1636	Single Over-The-Top Micropower Rail-to-Rail Input and Output Op Amp	55μA Supply Current, V_{CM} Extends 44V above V_{EE} , Independent of V_{CC} , MSOP Package, Shutdown Function
LT1638/LT1639	Dual/Quad 1.2MHz Over-The-Top Micropower, Rail-to-Rail Input and Output Op Amps	0.4V/μs Slew Rate, 230μA Supply Current per Amplifier
LT1782	Micropower, Over-The-Top, SOT-23, Rail-to-Rail Input and Output Op Amp	SOT-23, 800μV $V_{OS(MAX)}$, $I_S = 55μA$ (Max), Gain-Bandwidth = 200kHz, Shutdown Pin
LT1783	1.2MHz, Over-The-Top, Micropower, Rail-to-Rail Input and Output Op Amp	SOT-23, 800μV $V_{OS(MAX)}$, $I_S = 300μA$ (Max), Gain-Bandwidth = 1.2MHz, Shutdown Pin