

# Dual and Quad 250 $\mu$ A, 3MHz, 200V/ $\mu$ s Operational Amplifiers

## FEATURES

- 3MHz Gain Bandwidth
- 200V/ $\mu$ s Slew Rate
- 250 $\mu$ A Supply Current per Amplifier
- C-Load™ Op Amp Drives All Capacitive Loads
- Unity-Gain Stable
- Maximum Input Offset Voltage: 600 $\mu$ V
- Maximum Input Bias Current: 50nA
- Maximum Input Offset Current: 15nA
- Minimum DC Gain,  $R_L = 2k$ : 30V/mV
- Input Noise Voltage: 14nV/ $\sqrt{Hz}$
- Settling Time to 0.1%, 10V Step: 700ns
- Settling Time to 0.01%, 10V Step: 1.25 $\mu$ s
- Minimum Output Swing into 1k:  $\pm 13V$
- Minimum Output Swing into 500 $\Omega$ :  $\pm 3.4V$
- Specified at  $\pm 2.5V$ ,  $\pm 5V$  and  $\pm 15V$

## APPLICATIONS

- Battery-Powered Systems
- Wideband Amplifiers
- Buffers
- Active Filters
- Data Acquisition Systems
- Photodiode Amplifiers

## DESCRIPTION

The LT<sup>®</sup>1352/LT1353 are dual and quad, very low power, high speed operational amplifiers with outstanding AC and DC performance. The amplifiers feature much lower supply current and higher slew rate than devices with comparable bandwidth. The circuit combines the slewing performance of a current feedback amplifier in a true operational amplifier with matched high impedance inputs. The high slew rate ensures that the large-signal bandwidth is not degraded. Each output is capable of driving a 1k $\Omega$  load to  $\pm 13V$  with  $\pm 15V$  supplies and a 500 $\Omega$  load to  $\pm 3.4V$  on  $\pm 5V$  supplies.

The LT1352/LT1353 are members of a family of fast, high performance amplifiers using this unique topology and employing Linear Technology Corporation's advanced complementary bipolar processing. For higher bandwidth devices with higher supply current see the LT1354 through LT1365 data sheets. Bandwidths of 12MHz, 25MHz, 50MHz and 70MHz are available with 1mA, 2mA, 4mA and 6mA of supply current per amplifier. Singles, duals and quads of each amplifier are available.

LT, LTC and LT are registered trademarks of Linear Technology Corporation.  
C-Load is a trademark of Linear Technology Corporation.

## TYPICAL APPLICATION

Instrumentation Amplifier

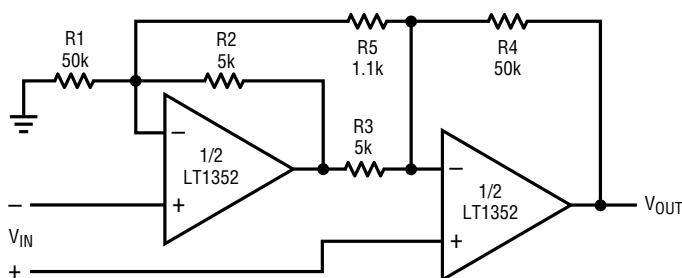

GAIN =  $[R4/R3][1 + (1/2)(R2/R1 + R3/R4) + (R2 + R3)/R5] = 102$   
 TRIM R5 FOR GAIN  
 TRIM R1 FOR COMMON MODE REJECTION  
 BW = 30kHz

1352/53 TA01

Large-Signal Response

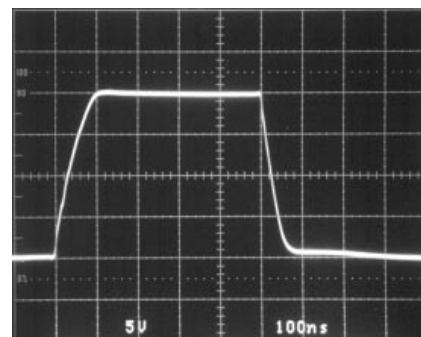

$A_v = -1$

1352/53 TA02

# LT1352/LT1353

## ABSOLUTE MAXIMUM RATINGS

Total Supply Voltage ( $V^+$  to  $V^-$ ) ..... 36V  
 Differential Input Voltage .....  $\pm 10V$   
 Input Voltage .....  $\pm V_S$   
 Output Short-Circuit Duration (Note 1) ..... Indefinite  
 Operating Temperature Range .....  $-40^\circ\text{C}$  to  $85^\circ\text{C}$

Specified Temperature Range .....  $-40^\circ\text{C}$  to  $85^\circ\text{C}$   
 Maximum Junction Temperature (See Below)  
     Plastic Package .....  $150^\circ\text{C}$   
 Storage Temperature Range .....  $-65^\circ\text{C}$  to  $150^\circ\text{C}$   
 Lead Temperature (Soldering, 10 sec) .....  $300^\circ\text{C}$

## PACKAGE/ORDER INFORMATION

|  |                        |  |                   |
|--|------------------------|--|-------------------|
| <p>N8 PACKAGE<br/>8-LEAD PDIP<br/>S8 PACKAGE<br/>8-LEAD PLASTIC SO</p> <p><math>T_{JMAX} = 150^\circ\text{C}</math>, <math>\theta_{JA} = 130^\circ\text{C/W}</math> (N8)<br/> <math>T_{JMAX} = 150^\circ\text{C}</math>, <math>\theta_{JA} = 190^\circ\text{C/W}</math> (S8)</p> | ORDER PART NUMBER      | <p>S PACKAGE<br/>14-LEAD PLASTIC SO</p> <p><math>T_{JMAX} = 150^\circ\text{C}</math>, <math>\theta_{JA} = 150^\circ\text{C/W}</math></p> | ORDER PART NUMBER |
|  | LT1352CN8<br>LT1352CS8 |  | LT1353CS          |
|  | S8 PART MARKING        |  |                   |
|  | 1352                   |  |                   |

Consult factory for Industrial and Military grade parts.

## ELECTRICAL CHARACTERISTICS $T_A = 25^\circ\text{C}$ , $V_{CM} = 0V$ unless otherwise noted.

| SYMBOL   | PARAMETER                    | CONDITIONS   | $V_{SUPPLY}$            | MIN   | TYP   | MAX | UNITS                        |
|----------|------------------------------|--|-------------------------|-------|-------|-----|------------------------------|
| $V_{OS}$ | Input Offset Voltage         |  | $\pm 15V$               | 0.2   | 0.6   |     | mV                           |
|          |                              |  | $\pm 5V$                | 0.2   | 0.6   |     | mV                           |
|          |                              |  | $\pm 2.5V$              | 0.3   | 0.8   |     | mV                           |
| $I_{OS}$ | Input Offset Current         |  | $\pm 2.5V$ to $\pm 15V$ | 5     | 15    |     | nA                           |
| $I_B$    | Input Bias Current           |  | $\pm 2.5V$ to $\pm 15V$ | 20    | 50    |     | nA                           |
| $e_n$    | Input Noise Voltage          | $f = 10\text{kHz}$   | $\pm 2.5V$ to $\pm 15V$ | 14    |       |     | $\text{nV}/\sqrt{\text{Hz}}$ |
| $i_n$    | Input Noise Current          | $f = 10\text{kHz}$   | $\pm 2.5V$ to $\pm 15V$ | 0.5   |       |     | $\text{pA}/\sqrt{\text{Hz}}$ |
| $R_{IN}$ | Input Resistance             | $V_{CM} = \pm 12V$<br>Differential                               | $\pm 15V$               | 300   | 600   |     | $\text{M}\Omega$             |
|          |                              |  | $\pm 15V$               |       | 20    |     | $\text{M}\Omega$             |
| $C_{IN}$ | Positive Input Voltage Range |  | $\pm 15V$               | 12.0  | 13.5  |     | V                            |
|          |                              |  | $\pm 5V$                | 2.5   | 3.5   |     | V                            |
|          |                              |  | $\pm 2.5V$              | 0.5   | 1.0   |     | V                            |
|          | Negative Input Voltage Range |  | $\pm 15V$               | -13.5 | -12.0 |     | V                            |
|          |                              |  | $\pm 5V$                | -3.5  | -2.5  |     | V                            |
|          |                              |  | $\pm 2.5V$              | -1.0  | -0.5  |     | V                            |
| CMRR     | Common Mode Rejection Ratio  | $V_{CM} = \pm 12V$<br>$V_{CM} = \pm 2.5V$<br>$V_{CM} = \pm 0.5V$ | $\pm 15V$               | 80    | 94    |     | dB                           |
|          |                              |  | $\pm 5V$                | 78    | 86    |     | dB                           |
|          |                              |  | $\pm 2.5V$              | 68    | 77    |     | dB                           |
| PSRR     | Power Supply Rejection Ratio | $V_S = \pm 2.5V$ to $\pm 15V$                                    |                         | 90    | 106   |     | dB                           |

**ELECTRICAL CHARACTERISTICS**  $T_A = 25^\circ\text{C}$ ,  $V_{CM} = 0\text{V}$  unless otherwise noted.

| SYMBOL        | PARAMETER                 | CONDITIONS                                       | $V_{SUPPLY}$      | MIN  | TYP  | MAX | UNITS            |
|---------------|---------------------------|--|-------------------|------|------|-----|------------------|
| $A_{VOL}$     | Large-Signal Voltage Gain | $V_{OUT} = \pm 12\text{V}$ , $R_L = 5\text{k}$   | $\pm 15\text{V}$  | 40   | 80   |     | V/mV             |
|               |                           | $V_{OUT} = \pm 10\text{V}$ , $R_L = 2\text{k}$   | $\pm 15\text{V}$  | 30   | 60   |     | V/mV             |
|               |                           | $V_{OUT} = \pm 10\text{V}$ , $R_L = 1\text{k}$   | $\pm 15\text{V}$  | 20   | 40   |     | V/mV             |
|               |                           | $V_{OUT} = \pm 2.5\text{V}$ , $R_L = 5\text{k}$  | $\pm 5\text{V}$   | 30   | 60   |     | V/mV             |
|               |                           | $V_{OUT} = \pm 2.5\text{V}$ , $R_L = 2\text{k}$  | $\pm 5\text{V}$   | 25   | 50   |     | V/mV             |
|               |                           | $V_{OUT} = \pm 2.5\text{V}$ , $R_L = 1\text{k}$  | $\pm 5\text{V}$   | 15   | 30   |     | V/mV             |
|               |                           | $V_{OUT} = \pm 1\text{V}$ , $R_L = 5\text{k}$    | $\pm 2.5\text{V}$ | 20   | 40   |     | V/mV             |
| $V_{OUT}$     | Output Swing              | $R_L = 5\text{k}$ , $V_{IN} = \pm 10\text{mV}$   | $\pm 15\text{V}$  | 13.5 | 14.0 |     | $\pm\text{V}$    |
|               |                           | $R_L = 2\text{k}$ , $V_{IN} = \pm 10\text{mV}$   | $\pm 15\text{V}$  | 13.4 | 13.8 |     | $\pm\text{V}$    |
|               |                           | $R_L = 1\text{k}$ , $V_{IN} = \pm 10\text{mV}$   | $\pm 15\text{V}$  | 13.0 | 13.4 |     | $\pm\text{V}$    |
|               |                           | $R_L = 1\text{k}$ , $V_{IN} = \pm 10\text{mV}$   | $\pm 5\text{V}$   | 3.5  | 4.0  |     | $\pm\text{V}$    |
|               |                           | $R_L = 500\Omega$ , $V_{IN} = \pm 10\text{mV}$   | $\pm 5\text{V}$   | 3.4  | 3.8  |     | $\pm\text{V}$    |
|               |                           | $R_L = 5\text{k}$ , $V_{IN} = \pm 10\text{mV}$   | $\pm 2.5\text{V}$ | 1.3  | 1.7  |     | $\pm\text{V}$    |
| $I_{OUT}$     | Output Current            | $V_{OUT} = \pm 13\text{V}$                       | $\pm 15\text{V}$  | 13.0 | 13.4 |     | mA               |
|               |                           | $V_{OUT} = \pm 3.4\text{V}$                      | $\pm 5\text{V}$   | 6.8  | 7.6  |     | mA               |
| $I_{SC}$      | Short-Circuit Current     | $V_{OUT} = 0\text{V}$ , $V_{IN} = \pm 3\text{V}$ | $\pm 15\text{V}$  | 30   | 45   |     | mA               |
| SR            | Slew Rate                 | $A_V = -1$ , $R_L = 5\text{k}$ (Note 2)          | $\pm 15\text{V}$  | 120  | 200  |     | V/ $\mu\text{s}$ |
|               |                           |  | $\pm 5\text{V}$   | 30   | 50   |     | V/ $\mu\text{s}$ |
| GBW           | Gain Bandwidth            | $f = 200\text{kHz}$ , $R_L = 10\text{k}$         | $\pm 15\text{V}$  |      | 3.2  |     | MHz              |
|               |                           |  | $\pm 5\text{V}$   |      | 2.6  |     | MHz              |
| $t_r$ , $t_f$ | Rise Time, Fall Time      | $A_V = 1$ , 10% to 90%, 0.1V                     | $\pm 15\text{V}$  |      | 46   |     | ns               |
|               |                           |  | $\pm 5\text{V}$   |      | 53   |     | ns               |
|               |                           |  | $\pm 15\text{V}$  |      | 13   |     | %                |
|               | Overshoot                 | $A_V = 1$ , 0.1V                                 | $\pm 5\text{V}$   |      | 16   |     | %                |
|               |                           |  | $\pm 15\text{V}$  |      | 41   |     | ns               |
|               | Propagation Delay         | 50% $V_{IN}$ to 50% $V_{OUT}$ , 0.1V             | $\pm 5\text{V}$   |      | 52   |     | ns               |
|               |                           |  | $\pm 15\text{V}$  |      | 700  |     | ns               |
| $t_s$         | Settling Time             | 10V Step, 0.1%, $A_V = -1$                       | $\pm 15\text{V}$  |      | 1250 |     | ns               |
|               |                           |  | $\pm 5\text{V}$   |      | 950  |     | ns               |
|               |                           |  | $\pm 15\text{V}$  |      | 1400 |     | ns               |
|               |                           |  | $\pm 5\text{V}$   |      | 1400 |     | ns               |
| $R_O$         | Output Resistance         | $A_V = 1$ , $f = 20\text{kHz}$                   | $\pm 15\text{V}$  |      | 1.5  |     | $\Omega$         |
|               |                           |  | $\pm 15\text{V}$  | 101  | 120  |     | dB               |
| $I_S$         | Supply Current            | Each Amplifier                                   | $\pm 15\text{V}$  |      | 250  | 320 | $\mu\text{A}$    |
|               |                           |  | $\pm 5\text{V}$   |      | 230  | 300 | $\mu\text{A}$    |

$0^\circ\text{C} \leq T_A \leq 70^\circ\text{C}$ ,  $V_{CM} = 0\text{V}$  unless otherwise noted.

| SYMBOL   | PARAMETER            | CONDITIONS | $V_{SUPPLY}$                          | MIN | TYP | MAX | UNITS                        |
|----------|----------------------|------------|---------------------------------------|-----|-----|-----|------------------------------|
| $V_{OS}$ | Input Offset Voltage |            | $\pm 15\text{V}$                      |     |     | 0.8 | mV                           |
|          |                      |            | $\pm 5\text{V}$                       |     |     | 0.8 | mV                           |
|          |                      |            | $\pm 2.5\text{V}$                     |     |     | 1.0 | mV                           |
|          | Input $V_{OS}$ Drift | (Note 4)   | $\pm 2.5\text{V}$ to $\pm 15\text{V}$ |     | 3   | 8   | $\mu\text{V}/^\circ\text{C}$ |
| $I_{OS}$ | Input Offset Current |            | $\pm 2.5\text{V}$ to $\pm 15\text{V}$ |     |     | 20  | nA                           |
| $I_B$    | Input Bias Current   |            | $\pm 2.5\text{V}$ to $\pm 15\text{V}$ |     |     | 75  | nA                           |

**ELECTRICAL CHARACTERISTICS**  $0^{\circ}\text{C} \leq T_A \leq 70^{\circ}\text{C}$ ,  $V_{\text{CM}} = 0\text{V}$  unless otherwise noted.

| SYMBOL           | PARAMETER                    | CONDITIONS   | V <sub>SUPPLY</sub> | MIN  | TYP | MAX | UNITS            |
|------------------|------------------------------|--|---------------------|------|-----|-----|------------------|
| CMRR             | Common Mode Rejection Ratio  | $V_{\text{CM}} = \pm 12\text{V}$                               | $\pm 15\text{V}$    | 78   |     |     | dB               |
|                  |                              | $V_{\text{CM}} = \pm 2.5\text{V}$                              | $\pm 5\text{V}$     | 77   |     |     | dB               |
|                  |                              | $V_{\text{CM}} = \pm 0.5\text{V}$                              | $\pm 2.5\text{V}$   | 67   |     |     | dB               |
| PSRR             | Power Supply Rejection Ratio | $V_S = \pm 2.5\text{V}$ to $\pm 15\text{V}$                    |                     | 89   |     |     | dB               |
| A <sub>VOL</sub> | Large-Signal Voltage Gain    | $V_{\text{OUT}} = \pm 12\text{V}$ , $R_L = 5\text{k}$          | $\pm 15\text{V}$    | 25   |     |     | V/mV             |
|                  |                              | $V_{\text{OUT}} = \pm 10\text{V}$ , $R_L = 2\text{k}$          | $\pm 15\text{V}$    | 20   |     |     | V/mV             |
|                  |                              | $V_{\text{OUT}} = \pm 2.5\text{V}$ , $R_L = 5\text{k}$         | $\pm 5\text{V}$     | 20   |     |     | V/mV             |
|                  |                              | $V_{\text{OUT}} = \pm 2.5\text{V}$ , $R_L = 2\text{k}$         | $\pm 5\text{V}$     | 15   |     |     | V/mV             |
|                  |                              | $V_{\text{OUT}} = \pm 2.5\text{V}$ , $R_L = 1\text{k}$         | $\pm 5\text{V}$     | 10   |     |     | V/mV             |
|                  |                              | $V_{\text{OUT}} = \pm 1\text{V}$ , $R_L = 5\text{k}$           | $\pm 2.5\text{V}$   | 15   |     |     | V/mV             |
| V <sub>OUT</sub> | Output Swing                 | $R_L = 5\text{k}$ , $V_{\text{IN}} = \pm 10\text{mV}$          | $\pm 15\text{V}$    | 13.4 |     |     | $\pm \text{V}$   |
|                  |                              | $R_L = 2\text{k}$ , $V_{\text{IN}} = \pm 10\text{mV}$          | $\pm 15\text{V}$    | 13.3 |     |     | $\pm \text{V}$   |
|                  |                              | $R_L = 1\text{k}$ , $V_{\text{IN}} = \pm 10\text{mV}$          | $\pm 15\text{V}$    | 12.0 |     |     | $\pm \text{V}$   |
|                  |                              | $R_L = 1\text{k}$ , $V_{\text{IN}} = \pm 10\text{mV}$          | $\pm 5\text{V}$     | 3.4  |     |     | $\pm \text{V}$   |
|                  |                              | $R_L = 500\Omega$ , $V_{\text{IN}} = \pm 10\text{mV}$          | $\pm 5\text{V}$     | 3.3  |     |     | $\pm \text{V}$   |
|                  |                              | $R_L = 5\text{k}$ , $V_{\text{IN}} = \pm 10\text{mV}$          | $\pm 2.5\text{V}$   | 1.2  |     |     | $\pm \text{V}$   |
| I <sub>OUT</sub> | Output Current               | $V_{\text{OUT}} = \pm 12\text{V}$                              | $\pm 15\text{V}$    | 12.0 |     |     | mA               |
|                  |                              | $V_{\text{OUT}} = \pm 3.3\text{V}$                             | $\pm 5\text{V}$     | 6.6  |     |     | mA               |
| I <sub>SC</sub>  | Short-Circuit Current        | $V_{\text{OUT}} = 0\text{V}$ , $V_{\text{IN}} = \pm 3\text{V}$ | $\pm 15\text{V}$    | 24   |     |     | mA               |
| SR               | Slew Rate                    | $A_V = -1$ , $R_L = 5\text{k}$ (Note 2)                        | $\pm 15\text{V}$    | 100  |     |     | V/ $\mu\text{s}$ |
|                  |                              |  | $\pm 5\text{V}$     | 21   |     |     | V/ $\mu\text{s}$ |
| GBW              | Gain Bandwidth               | $f = 200\text{kHz}$ , $R_L = 10\text{k}$                       | $\pm 15\text{V}$    | 1.8  |     |     | MHz              |
|                  |                              |  | $\pm 5\text{V}$     | 1.6  |     |     | MHz              |
|                  | Channel Separation           | $V_{\text{OUT}} = \pm 10\text{V}$ , $R_L = 2\text{k}$          | $\pm 15\text{V}$    | 100  |     |     | dB               |
| I <sub>S</sub>   | Supply Current               | Each Amplifier   | $\pm 15\text{V}$    |      |     | 350 | $\mu\text{A}$    |
|                  |                              |  | $\pm 5\text{V}$     |      |     | 330 | $\mu\text{A}$    |

$-40^{\circ}\text{C} \leq T_A \leq 85^{\circ}\text{C}$ ,  $V_{\text{CM}} = 0\text{V}$  unless otherwise noted (Note 5).

| SYMBOL           | PARAMETER                    | CONDITIONS   | V <sub>SUPPLY</sub>                   | MIN | TYP | MAX | UNITS                          |
|------------------|------------------------------|--|---------------------------------------|-----|-----|-----|--------------------------------|
| V <sub>OS</sub>  | Input Offset Voltage         |  | $\pm 15\text{V}$                      |     |     | 1.0 | mV                             |
|                  |                              |  | $\pm 5\text{V}$                       |     |     | 1.0 | mV                             |
|                  |                              |  | $\pm 2.5\text{V}$                     |     |     | 1.2 | mV                             |
|                  | Input V <sub>OS</sub> Drift  | (Note 4)   | $\pm 2.5\text{V}$ to $\pm 15\text{V}$ |     | 3   | 8   | $\mu\text{V}/^{\circ}\text{C}$ |
| I <sub>OS</sub>  | Input Offset Current         |  | $\pm 2.5\text{V}$ to $\pm 15\text{V}$ |     |     | 30  | nA                             |
| I <sub>B</sub>   | Input Bias Current           |  | $\pm 2.5\text{V}$ to $\pm 15\text{V}$ |     |     | 100 | nA                             |
| CMRR             | Common Mode Rejection Ratio  | $V_{\text{CM}} = \pm 12\text{V}$<br>$V_{\text{CM}} = \pm 2.5\text{V}$<br>$V_{\text{CM}} = \pm 0.5\text{V}$ | $\pm 15\text{V}$                      | 76  |     |     | dB                             |
|                  |                              |  | $\pm 5\text{V}$                       | 76  |     |     | dB                             |
|                  |                              |  | $\pm 2.5\text{V}$                     | 66  |     |     | dB                             |
| PSRR             | Power Supply Rejection Ratio | $V_S = \pm 2.5\text{V}$ to $\pm 15\text{V}$  |                                       | 87  |     |     | dB                             |
| A <sub>VOL</sub> | Large-Signal Voltage Gain    | $V_{\text{OUT}} = \pm 12\text{V}$ , $R_L = 5\text{k}$  | $\pm 15\text{V}$                      | 20  |     |     | V/mV                           |
|                  |                              | $V_{\text{OUT}} = \pm 10\text{V}$ , $R_L = 2\text{k}$  | $\pm 15\text{V}$                      | 15  |     |     | V/mV                           |
|                  |                              | $V_{\text{OUT}} = \pm 2.5\text{V}$ , $R_L = 5\text{k}$   | $\pm 5\text{V}$                       | 15  |     |     | V/mV                           |
|                  |                              | $V_{\text{OUT}} = \pm 2.5\text{V}$ , $R_L = 2\text{k}$   | $\pm 5\text{V}$                       | 10  |     |     | V/mV                           |
|                  |                              | $V_{\text{OUT}} = \pm 2.5\text{V}$ , $R_L = 1\text{k}$   | $\pm 5\text{V}$                       | 8   |     |     | V/mV                           |
|                  |                              | $V_{\text{OUT}} = \pm 1\text{V}$ , $R_L = 5\text{k}$   | $\pm 2.5\text{V}$                     | 10  |     |     | V/mV                           |

**ELECTRICAL CHARACTERISTICS**  $-40^{\circ}\text{C} \leq T_A \leq 85^{\circ}\text{C}$ ,  $V_{\text{CM}} = 0\text{V}$  unless otherwise noted (Note 4).

| SYMBOL           | PARAMETER             | CONDITIONS  | V <sub>SUPPLY</sub> | MIN  | TYP | MAX | UNITS |
|------------------|-----------------------|---|---------------------|------|-----|-----|-------|
| V <sub>OUT</sub> | Output Swing          | R <sub>L</sub> = 5k, V <sub>IN</sub> = ±10mV      | ±15V                | 13.3 |     |     | ±V    |
|                  |                       | R <sub>L</sub> = 2k, V <sub>IN</sub> = ±10mV      | ±15V                | 13.2 |     |     | ±V    |
|                  |                       | R <sub>L</sub> = 1k, V <sub>IN</sub> = ±10mV      | ±15V                | 10.0 |     |     | ±V    |
|                  |                       | R <sub>L</sub> = 1k, V <sub>IN</sub> = ±10mV      | ±5V                 | 3.3  |     |     | ±V    |
|                  |                       | R <sub>L</sub> = 500Ω, V <sub>IN</sub> = ±10mV    | ±5V                 | 3.2  |     |     | ±V    |
|                  |                       | R <sub>L</sub> = 5k, V <sub>IN</sub> = ±10mV      | ±2.5V               | 1.1  |     |     | ±V    |
| I <sub>OUT</sub> | Output Current        | V <sub>OUT</sub> = ±10V                           | ±15V                | 10.0 |     |     | mA    |
|                  |                       | V <sub>OUT</sub> = ±3.2V                          | ±5V                 | 6.4  |     |     | mA    |
| I <sub>SC</sub>  | Short-Circuit Current | V <sub>OUT</sub> = 0V, V <sub>IN</sub> = ±3V      | ±15V                | 20   |     |     | mA    |
| SR               | Slew Rate             | A <sub>V</sub> = -1, R <sub>L</sub> = 5k (Note 2) | ±15V                | 50   |     |     | V/μs  |
|                  |                       |   | ±5V                 | 15   |     |     | V/μs  |
| GBW              | Gain Bandwidth        | f = 200kHz, R <sub>L</sub> = 10k                  | ±15V                | 1.6  |     |     | MHz   |
|                  |                       |   | ±5V                 | 1.4  |     |     | MHz   |
|                  | Channel Separation    | V <sub>OUT</sub> = ±10V, R <sub>L</sub> = 2k      | ±15V                | 99   |     |     | dB    |
| I <sub>S</sub>   | Supply Current        | Each Amplifier                                    | ±15V                |      |     | 380 | μA    |
|                  |                       |   | ±5V                 |      |     | 350 | μA    |

**Note 1:** A heat sink may be required to keep the junction temperature below absolute maximum when the output is shorted indefinitely.

**Note 2:** Slew rate is measured between ±8V on the output with ±12V input for ±15V supplies and ±2V on the output with ±3V input for ±5V supplies.

**Note 3:** Full-power bandwidth is calculated from the slew rate measurement:  $\text{FPBW} = (\text{Slew Rate})/2\pi V_p$ .

**Note 4:** This parameter is not 100% tested.

**Note 5:** The LT1352/LT1353 are designed, characterized and expected to meet these extended temperature limits, but are not tested at -40°C and 85°C. Guaranteed I grade parts are available, consult factory.

**TYPICAL PERFORMANCE CHARACTERISTICS**

Supply Current vs Supply Voltage and Temperature

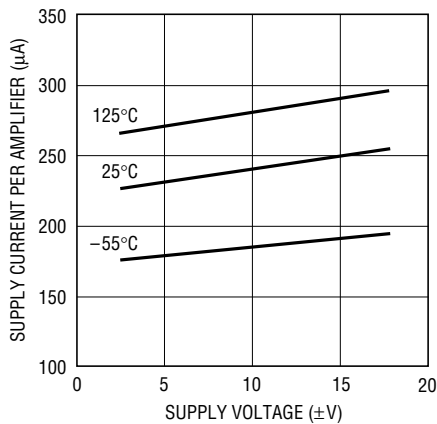

1352/53 G01

Input Common Mode Range vs Supply Voltage

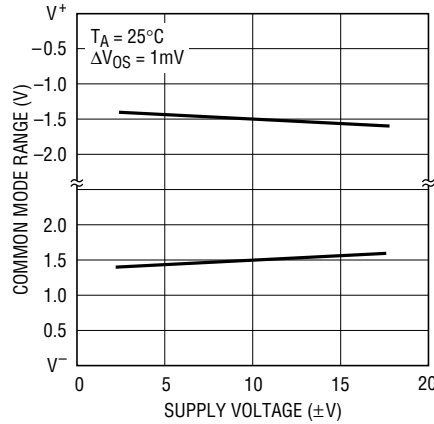

1352/53 G02

Input Bias Current vs Input Common Mode Voltage

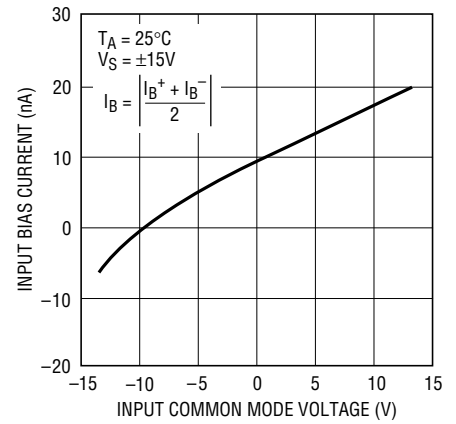

1352/53 G03

TYPICAL PERFORMANCE CHARACTERISTICS

Input Bias Current vs Temperature

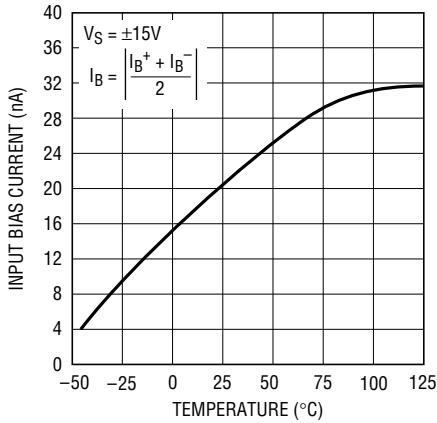

1352/53 G04

Input Noise Spectral Density

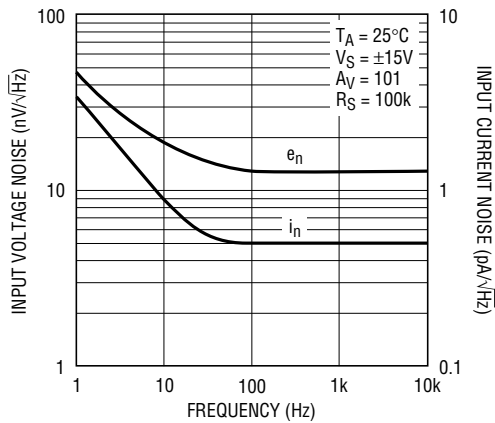

1352/53 G05

Open-Loop Gain vs Resistive Load

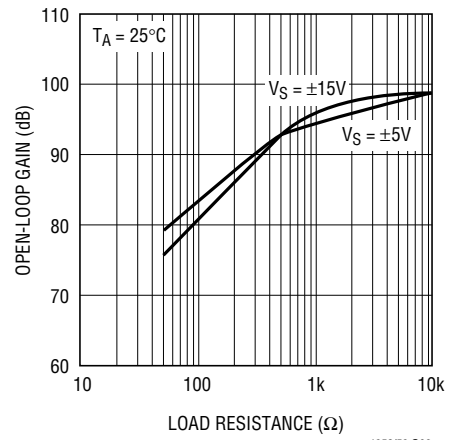

1352/53 G06

Open-Loop Gain vs Temperature

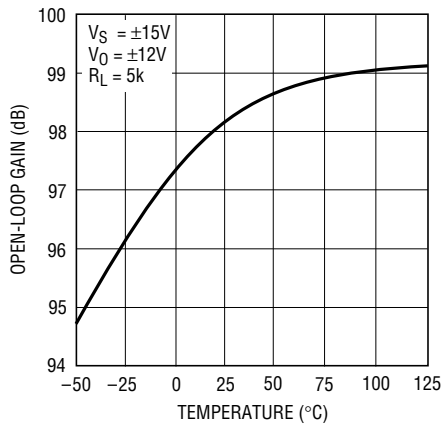

1352/53 G07

Output Voltage Swing vs Supply Voltage

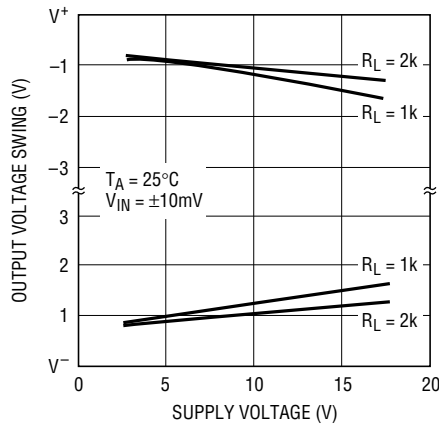

1352/53 G08

Output Voltage Swing vs Load Current

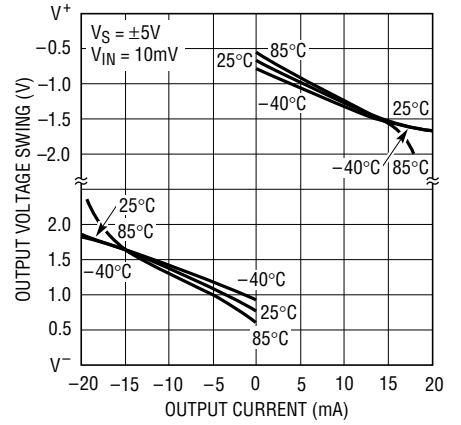

1352/53 G09

Output Short-Circuit Current vs Temperature

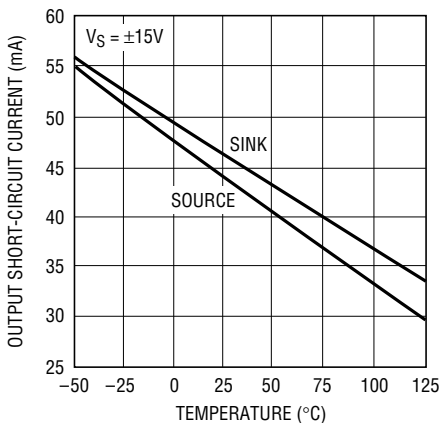

1352/53 G10

Settling Time vs Output Step (Noninverting)

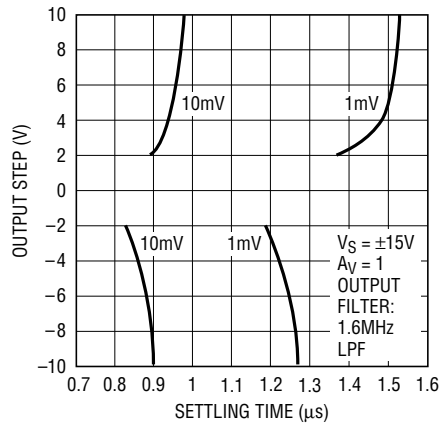

1352/53 G11

Settling Time vs Output Step (Inverting)

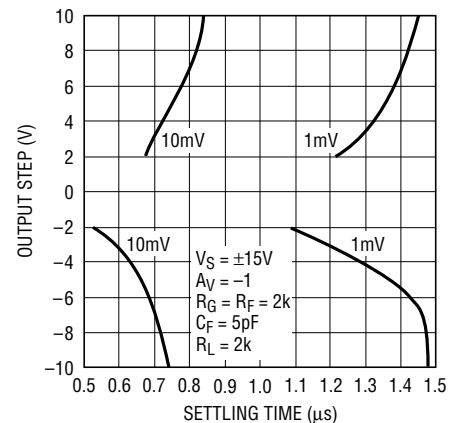

1352/53 G12

# TYPICAL PERFORMANCE CHARACTERISTICS

**Gain and Phase vs Frequency**

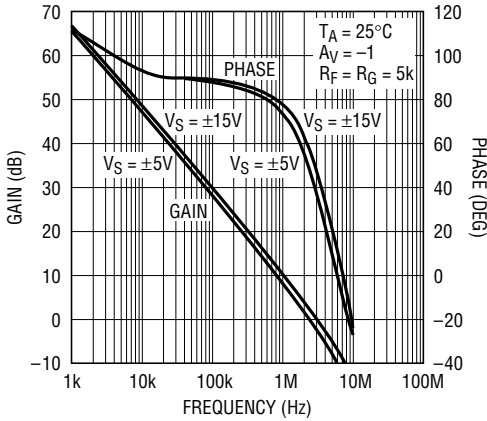

1352/53 G13

**Output Impedance vs Frequency**

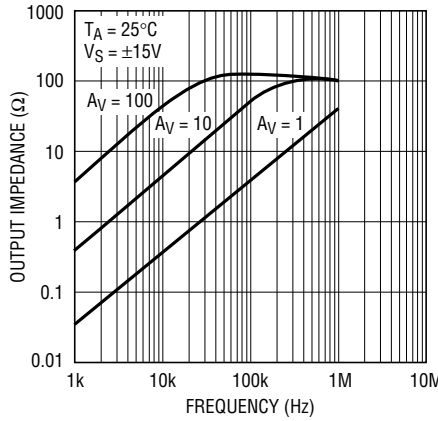

1352/53 G14

**Frequency Response vs Capacitive Load**

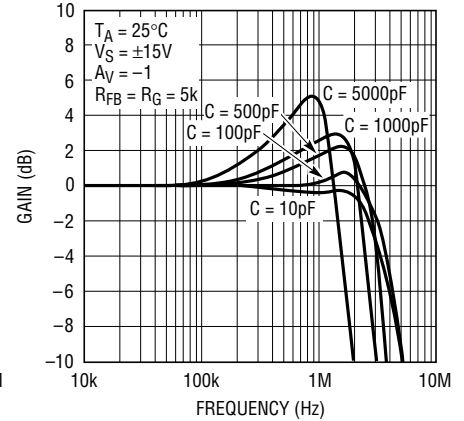

1352/53 G15

**Gain Bandwidth and Phase Margin vs Temperature**

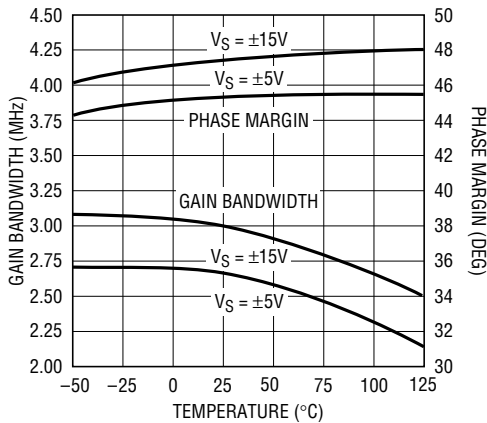

1352/53 G16

**Frequency Response vs Supply Voltage (AV = 1)**

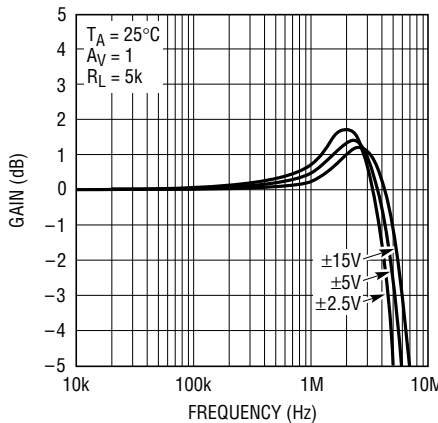

1352/53 G17

**Frequency Response vs Supply Voltage (AV = -1)**

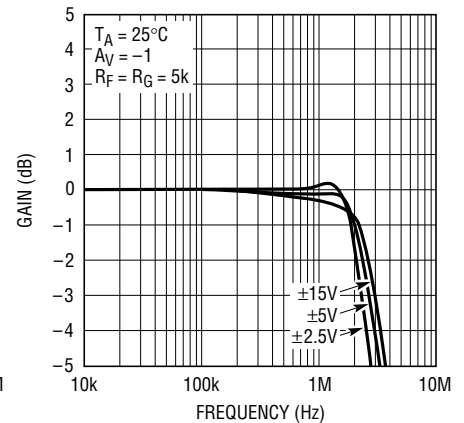

1352/53 G18

**Gain Bandwidth and Phase Margin vs Supply Voltage**

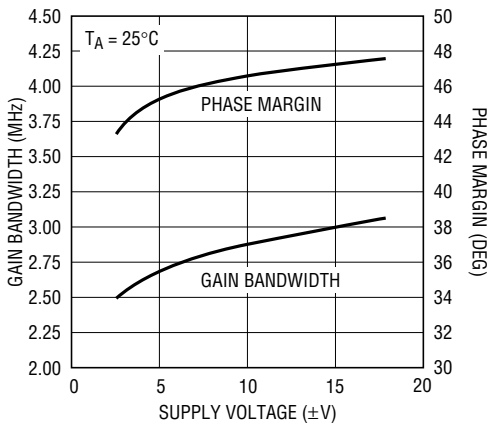

1352/53 G19

**Power Supply Rejection Ratio vs Frequency**

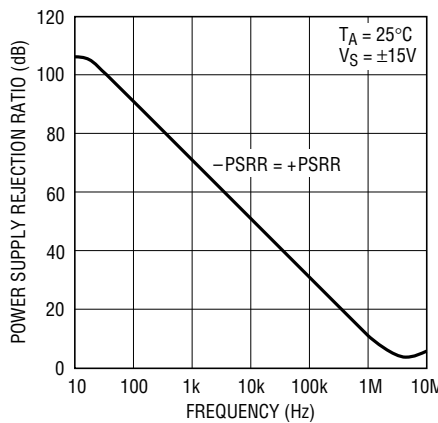

1352/53 G20

**Common Mode Rejection Ratio vs Frequency**

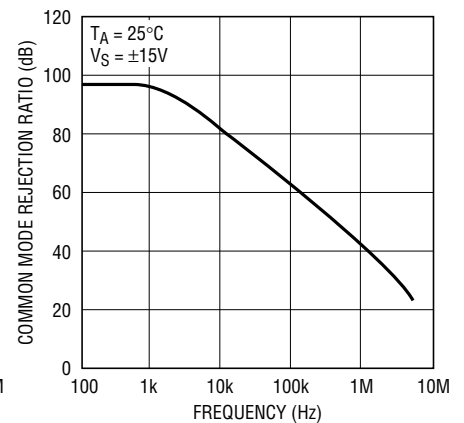

1352/53 G21

**TYPICAL PERFORMANCE CHARACTERISTICS**

**Slew Rate vs Supply Voltage**

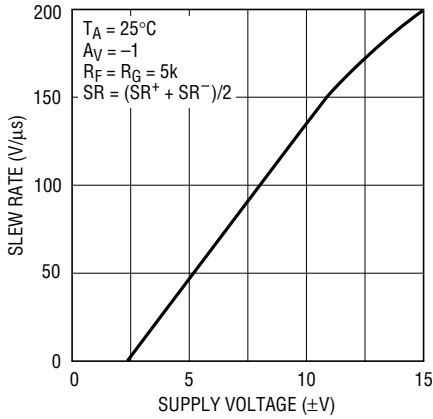

1352/53 G22

**Slew Rate vs Temperature**

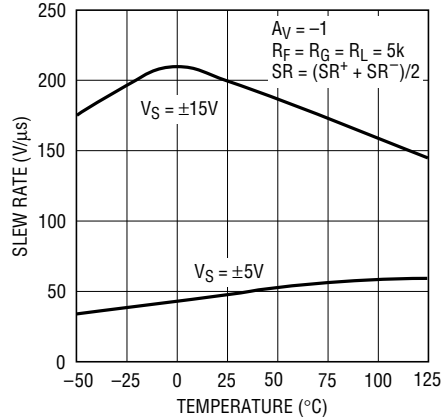

1352/53 G23

**Slew Rate vs Input Level**

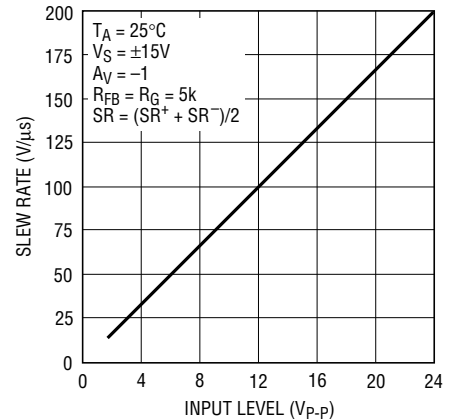

1352/53 G24

**Total Harmonic Distortion vs Frequency**

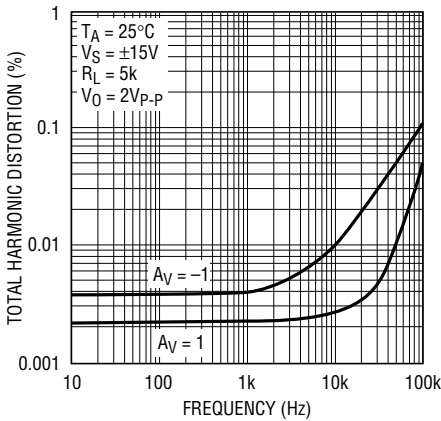

1352/53 G25

**Undistorted Output Swing vs Frequency (±15V)**

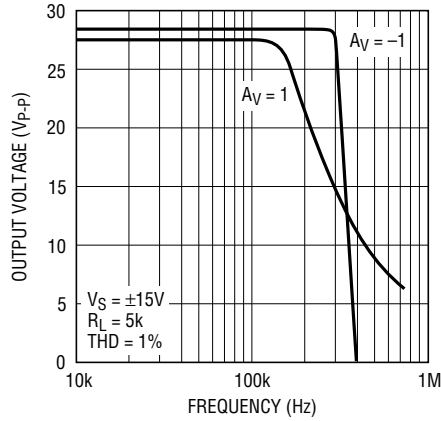

1352/53 G26

**Undistorted Output Swing vs Frequency (±5V)**

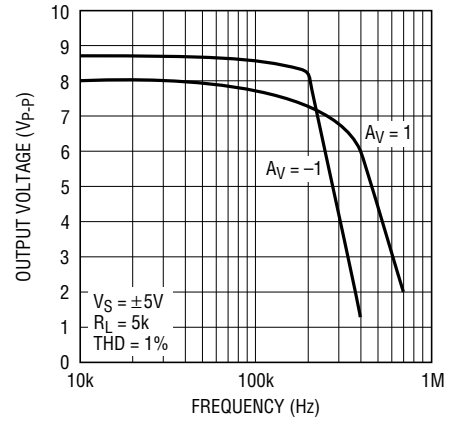

1352/53 G27

**2nd and 3rd Harmonic Distortion vs Frequency**

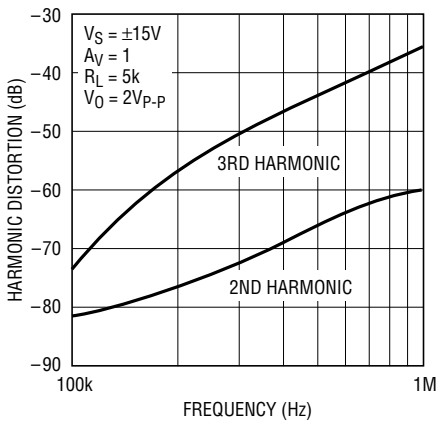

1352/53 G28

**Crosstalk vs Frequency**

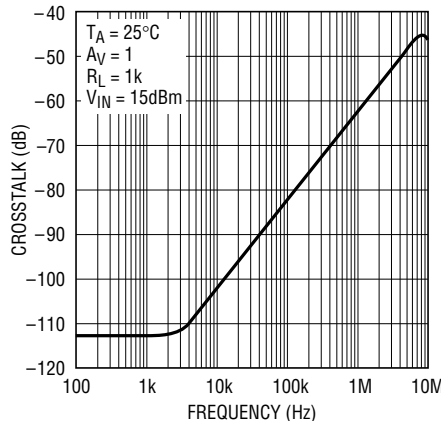

1352/53 G29

**Capacitive Load Handling**

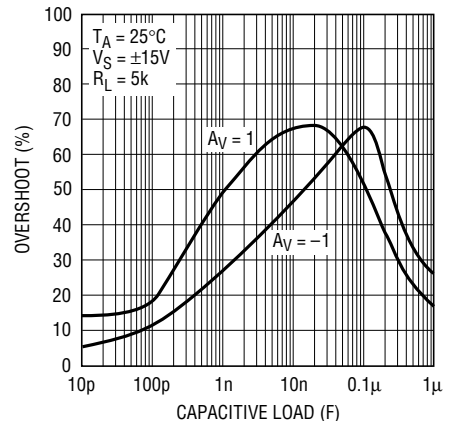

1352/53 G30



## TYPICAL PERFORMANCE CHARACTERISTICS

Small-Signal Transient  
( $A_V = 1$ )

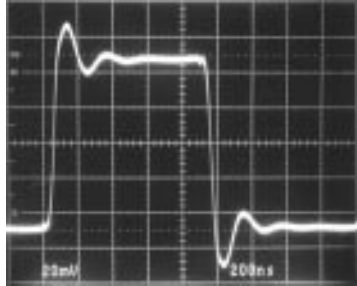

1352/53 G31

Small-Signal Transient  
( $A_V = -1$ )

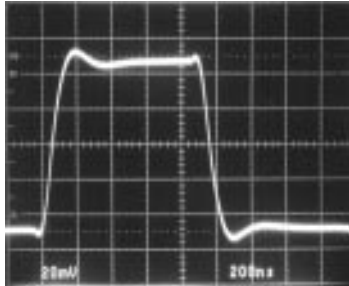

1352/53 G32

Small-Signal Transient  
( $A_V = -1, C_L = 1000\text{pF}$ )

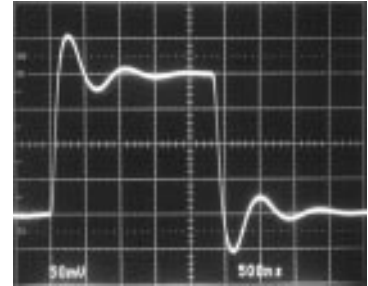

1352/53 G33

Large-Signal Transient  
( $A_V = 1$ )

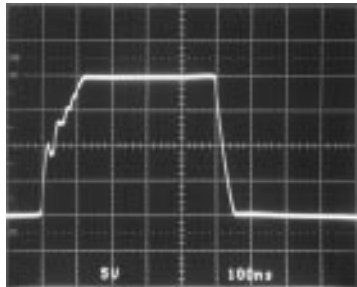

1352/53 G34

Large-Signal Transient  
( $A_V = -1$ )

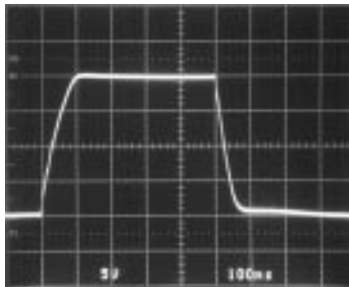

1352/53 G35

Large-Signal Transient  
( $A_V = 1, C_L = 10,000\text{pF}$ )

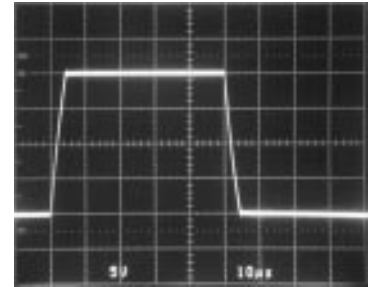

1352/53 G36

## APPLICATIONS INFORMATION

### Layout and Passive Components

The LT1352/LT1353 amplifiers are easy to use and tolerant of less than ideal layouts. For maximum performance (for example, fast 0.01% settling) use a ground plane, short lead lengths and RF-quality bypass capacitors (0.01 $\mu\text{F}$  to 0.1 $\mu\text{F}$ ). For high drive current applications use low ESR bypass capacitors (1 $\mu\text{F}$  to 10 $\mu\text{F}$  tantalum).

The parallel combination of the feedback resistor and gain setting resistor on the inverting input can combine with the input capacitance to form a pole which can cause peaking or even oscillations. If feedback resistors greater than 10k are used, a parallel capacitor of value,  $C_F > (R_G)(C_{IN}/R_F)$ , should be used to cancel the input pole and optimize dynamic performance. For applications where the DC noise gain is one and a large feedback resistor is used,  $C_F$  should be greater than or equal to  $C_{IN}$ . An example would be an I-to-V converter as shown in the Typical Applications section.

### Capacitive Loading

The LT1352/LT1353 are stable with any capacitive load. As the capacitive load increases, both the bandwidth and phase margin decrease so there will be peaking in the frequency domain and in the transient response. Graphs of Frequency Response vs Capacitive Load, Capacitive Load Handling and the transient response photos clearly show these effects.

### Input Considerations

Each of the LT1352/LT1353 amplifier inputs is the base of an NPN and PNP transistor whose base currents are of opposite polarity and provide first order bias current cancellation. Because of variation in the matching of NPN and PNP beta, the polarity of the input current can be positive or negative. The offset current does not depend on NPN to PNP beta matching and is well controlled. The use of balanced source resistance at each input is recom-

## APPLICATIONS INFORMATION

mended for applications where DC accuracy must be maximized. The inputs can withstand differential input voltages of up to 10V without damage and need no clamping or source resistance for protection. Differential inputs generate large supply currents (up to 40mA) as required for high slew rates. Typically power dissipation does not significantly increase because of the low duty cycle of the transient inputs. If the device is used as a comparator with sustained differential inputs, excessive power dissipation may result.

### Circuit Operation

The LT1352/LT1353 circuit topology is a true voltage feedback amplifier that has the slewing behavior of a current feedback amplifier. The operation of the circuit can be understood by referring to the Simplified Schematic.

The inputs are buffered by complementary NPN and PNP emitter followers which drive R1, a 1k resistor. The input voltage appears across the resistor generating currents which are mirrored into the high impedance node and compensation capacitor  $C_T$ . Complementary followers form an output stage which buffers the gain node from the load. The output devices Q19 and Q22 are connected to form a composite PNP and a composite NPN.

The bandwidth is set by the input resistor and the capacitance on the high impedance node. The slew rate is determined by the current available to charge the high impedance node capacitance. This current is the differential input voltage divided by R1, so the slew rate is proportional to the input. Highest slew rates are therefore seen in the lowest gain configurations. For example, a 10V output step in a gain of 10 has only a 1V input step whereas the same output step in unity gain has a 10 times greater input step. The graph Slew Rate vs Input Level illustrates this relationship. In higher gain configurations the large-signal performance and the small-signal performance both look like a single pole response.

Capacitive load compensation is provided by the  $R_C$ ,  $C_C$  network which is bootstrapped across the output stage. When the amplifier is driving a light load the network has no effect. When driving a capacitive load (or a low value resistive load) the network is incompletely bootstrapped and adds to the compensation at the high impedance node. The added capacitance slows down the amplifier and a zero is created by the RC combination, both of which improve the phase margin. The design ensures that even for very large load capacitances, the total phase lag can never exceed 180 degrees (zero phase margin) and the amplifier remains stable.

### Power Dissipation

The LT1352/LT1353 combine high speed and large output drive in small packages. Because of the wide supply voltage range, it is possible to exceed the maximum junction temperature of 150°C under certain conditions. Maximum junction temperature  $T_J$  is calculated from the ambient temperature  $T_A$  and power dissipation  $P_D$  as follows:

$$\text{LT1352CN8: } T_J = T_A + (P_D)(130^\circ\text{C/W})$$

$$\text{LT1352CS8: } T_J = T_A + (P_D)(190^\circ\text{C/W})$$

$$\text{LT1353CS: } T_J = T_A + (P_D)(150^\circ\text{C/W})$$

Worst-case power dissipation occurs at the maximum supply current and when the output voltage is at 1/2 of either supply voltage (or the maximum swing if less than 1/2 supply voltage). For each amplifier  $P_{D(\text{MAX})}$  is:

$$P_{D(\text{MAX})} = (V^+ - V^-)(I_{S(\text{MAX})}) + (V^+/2)^2/R_L \text{ or } (V^+ - V^-)(I_{S(\text{MAX})}) + (V^+ - V_{\text{MAX}})(I_{\text{MAX}})$$

Example: LT1353 in S14 at 85°C,  $V_S = \pm 15\text{V}$ ,  $R_L = 500\Omega$ ,  $V_{\text{OUT}} = \pm 5\text{V}$  ( $\pm 10\text{mA}$ )

$$P_{D(\text{MAX})} = (30\text{V})(380\mu\text{A}) + (15\text{V} - 5\text{V})(10\text{mA}) = 111\text{mW}$$

$$T_J = 85^\circ\text{C} + (4)(111\text{mW})(150^\circ\text{C/W}) = 152^\circ\text{C}$$

### SIMPLIFIED SCHEMATIC

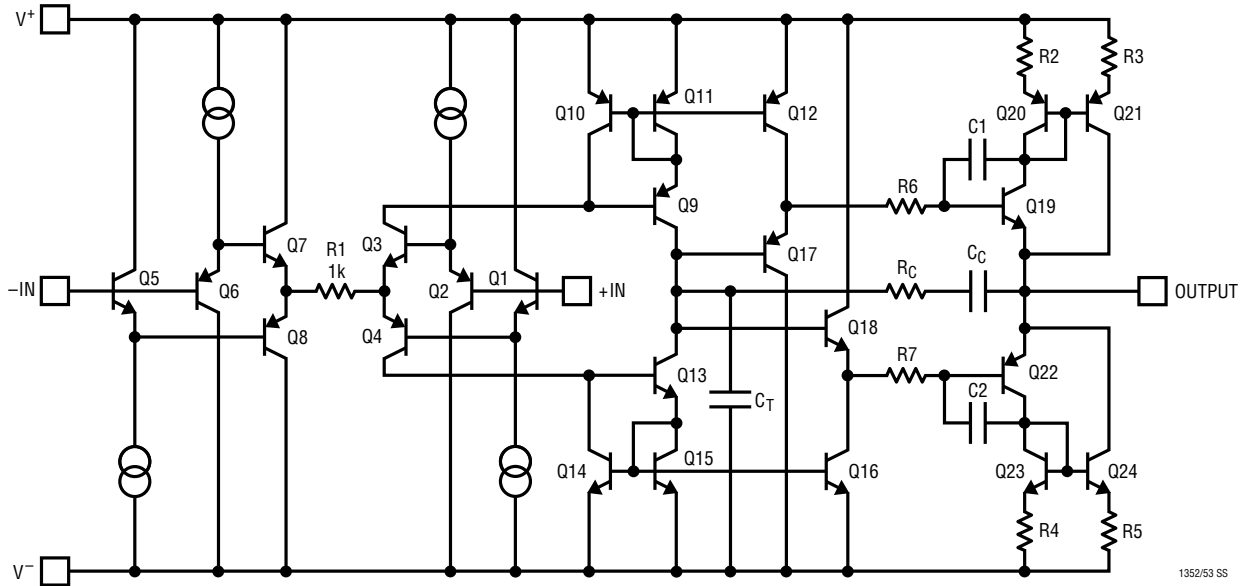

### TYPICAL APPLICATIONS

DAC I-to-V Converter

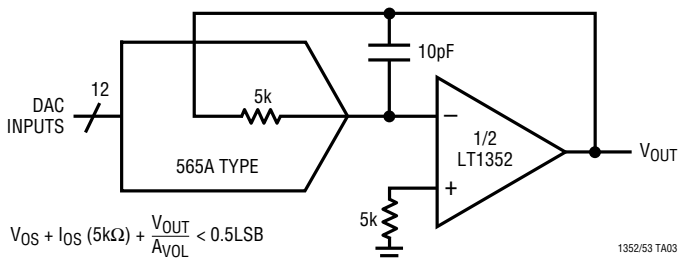

400kHz Photodiode Preamp with 10kHz Highpass Loop

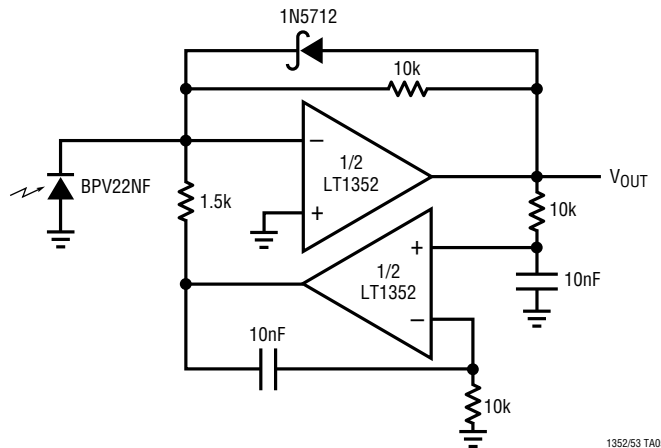

20kHz, 4th Order Butterworth Filter

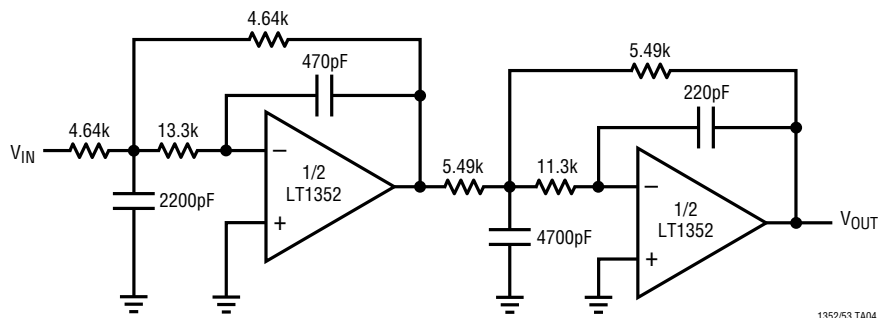

**PACKAGE DESCRIPTION** Dimensions in inches (millimeters) unless otherwise noted.

**N8 Package**  
**8-Lead PDIP (Narrow 0.300)**  
 (LTC DWG # 05-08-1510)

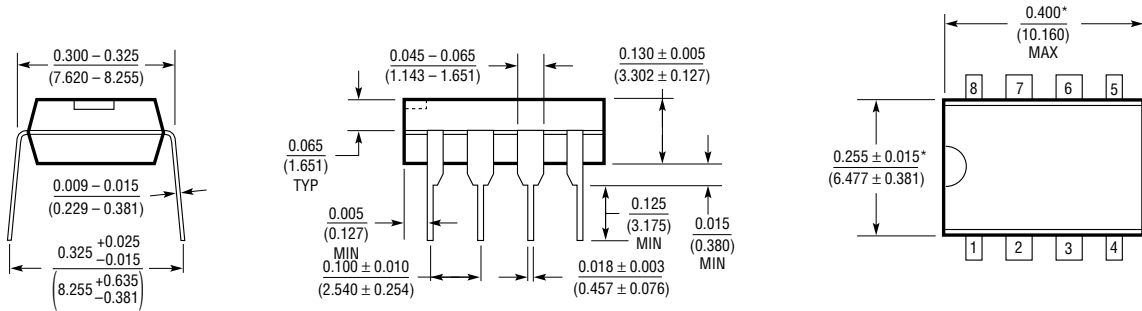

\*THESE DIMENSIONS DO NOT INCLUDE MOLD FLASH OR PROTRUSIONS.  
 MOLD FLASH OR PROTRUSIONS SHALL NOT EXCEED 0.010 INCH (0.254mm)

**S8 Package**  
**8-Lead Plastic Small Outline (Narrow 0.150)**  
 (LTC DWG # 05-08-1610)

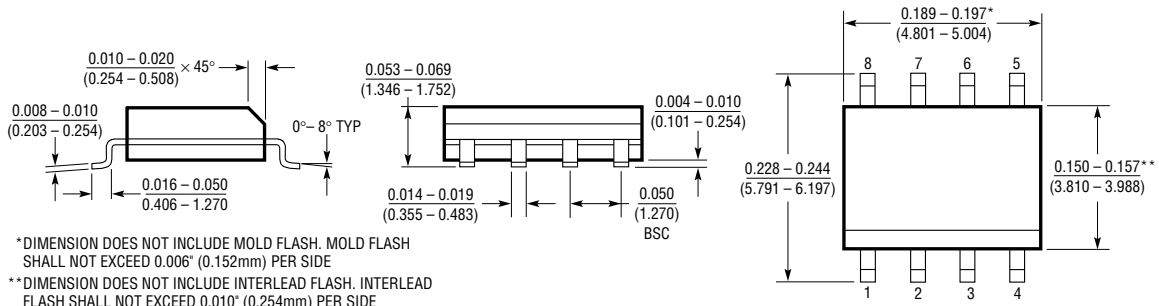

\* DIMENSION DOES NOT INCLUDE MOLD FLASH. MOLD FLASH SHALL NOT EXCEED 0.006" (0.152mm) PER SIDE  
 \*\* DIMENSION DOES NOT INCLUDE INTERLEAD FLASH. INTERLEAD FLASH SHALL NOT EXCEED 0.010" (0.254mm) PER SIDE

**S Package**  
**14-Lead Plastic Small Outline (Narrow 0.150)**  
 (LTC DWG # 05-08-1610)

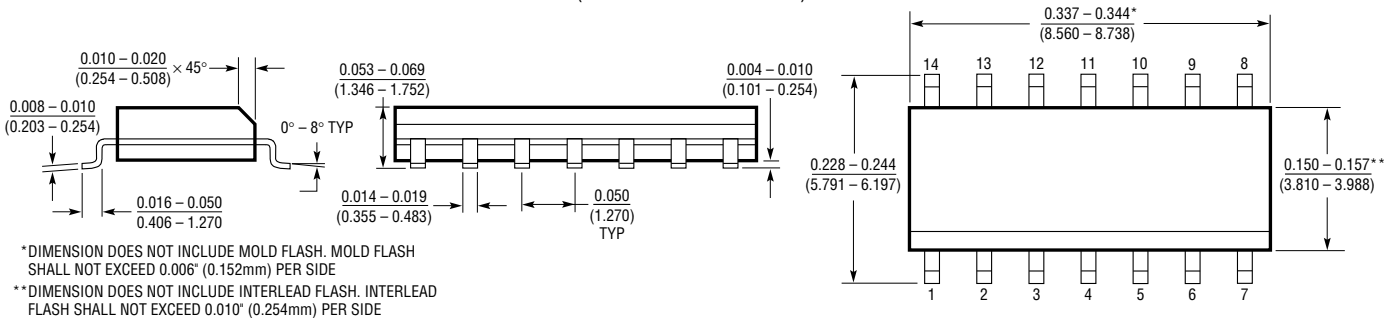

\* DIMENSION DOES NOT INCLUDE MOLD FLASH. MOLD FLASH SHALL NOT EXCEED 0.006" (0.152mm) PER SIDE  
 \*\* DIMENSION DOES NOT INCLUDE INTERLEAD FLASH. INTERLEAD FLASH SHALL NOT EXCEED 0.010" (0.254mm) PER SIDE

**RELATED PARTS**

| PART NUMBER  | DESCRIPTION                                 | COMMENTS  |
|--------------|---|---|
| LT1351       | 250µA, 3MHz, 200V/µs Op Amp                 | Good DC Precision, C-Load Stable, Power Saving Shutdown |
| LT1354/55/56 | Single/Dual/Quad 1mA, 12MHz, 400V/µs Op Amp | Good DC Precision, Stable with All Capacitive Loads     |