

LMC6001 Ultra Ultra-Low Input Current Amplifier

General Description

Featuring 100% tested input currents of 25 fA max., low operating power, and ESD protection of 2000V, the LMC6001 achieves a new industry benchmark for low input current operational amplifiers. By tightly controlling the molding compound, National is able to offer this ultra-low input current in a lower cost molded package.

To avoid long turn-on settling times common in other low input current opamps, the LMC6001A is tested 3 times in the first minute of operation. Even units that meet the 25 fA limit are rejected if they drift.

Because of the ultra-low input current noise of $0.13 \text{ fA}/\sqrt{\text{Hz}}$, the LMC6001 can provide almost noiseless amplification of high resistance signal sources. Adding only 1 dB at 100 k Ω , 0.1 dB at 1 M Ω and 0.01 dB or less from 10 M Ω to 2,000 M Ω , the LMC6001 is an almost noiseless amplifier.

The LMC6001 is ideally suited for electrometer applications requiring ultra-low input leakage such as sensitive photode-

tection transimpedance amplifiers and sensor amplifiers. Since input referred noise is only $22 \text{ nV}/\sqrt{\text{Hz}}$, the LMC6001 can achieve higher signal to noise ratio than JFET input type electrometer amplifiers. Other applications of the LMC6001 include long interval integrators, ultra-high input impedance instrumentation amplifiers, and sensitive electrical-field measurement circuits.

Features (Max limit, 25°C unless otherwise noted)

- Input current (100% tested) 25 fA
- Input current over temp. 2 pA
- Low power 750 μA
- Low V_{OS} 350 μV
- Low noise $22 \text{ nV}/\sqrt{\text{Hz}}$ @1 kHz Typ.

Applications

- Electrometer amplifier
- Photodiode preamplifier
- Ion detector
- A.T.E. leakage testing

Connection Diagrams

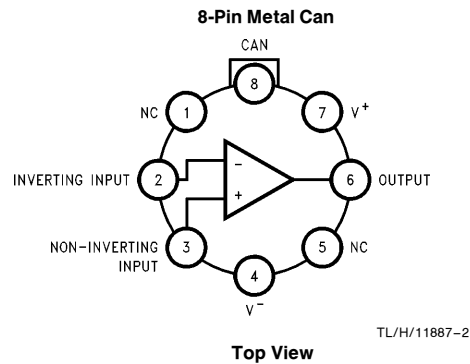
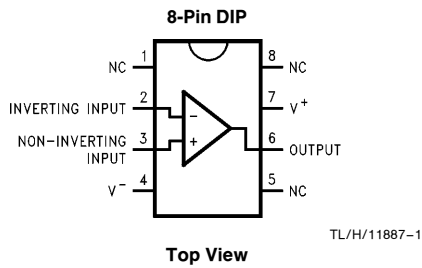

Ordering Information

Package	Industrial Temperature Range -40°C to +85°C	NSC Package Drawing
8-Pin Molded DIP	LMC6001AIN, LMC6001BIN, LMC6001CIN	N08E
8-Pin Metal Can	LMC6001AIH, LMC6001BIH	H08C

Absolute Maximum Ratings (Note 1)

If Military/Aerospace specified devices are required, please contact the National Semiconductor Sales Office/Distributors for availability and specifications.

Differential Input Voltage	\pm Supply Voltage
Voltage at Input/Output Pin	$(V^+) + 0.3V, (V^-) - 0.3V$
Supply Voltage ($V^+ - V^-$)	$-0.3V$ to $+16V$
Output Short Circuit to V^+	(Notes 2, 10)
Output Short Circuit to V^-	(Note 2)
Lead Temperature (Soldering, 10 Sec.)	260°C
Storage Temperature	-65°C to $+150^\circ\text{C}$
Junction Temperature	150°C
Current at Input Pin	$\pm 10\text{ mA}$

Current at Output Pin	$\pm 30\text{ mA}$
Current at Power Supply Pin	40 mA
Power Dissipation	(Note 3)
ESD Tolerance (Note 9)	2 kV

Operating Ratings (Note 1)

Temperature Range	LMC6001AI, LMC6001BI, LMC6001CI
	$-40^\circ\text{C} \leq T_J \leq +85^\circ\text{C}$
Supply Voltage	$4.5V \leq V^+ \leq 15.5V$
Thermal Resistance (Note 11)	
θ_{JA} , N Package	100°C/W
θ_{JA} , H Package	145°C/W
θ_{JC} , H Package	45°C/W
Power Dissipation	(Note 8)

DC Electrical Characteristics

Limits in standard typeface guaranteed for $T_J = 25^\circ\text{C}$ and limits in **boldface type** apply at the temperature extremes. Unless otherwise specified, $V^+ = 5V$, $V^- = 0V$, $V_{CM} = 1.5V$, and $R_L > 1M$.

Symbol	Parameter	Conditions	Typical (Note 4)	Limits (Note 5)			Units
				LMC6001AI	LMC6001BI	LMC6001CI	
I_B	Input Current	Either Input, $V_{CM} = 0V$, $V_S = \pm 5V$	10	25 2000	100 4000	1000 4000	fA
I_{OS}	Input Offset Current		5	1000	2000	2000	
V_{OS}	Input Offset Voltage			0.35 1.0	1.0 1.7	1.0 2.0	mV
		$V_S = \pm 5V, V_{CM} = 0V$		0.7 1.35	1.35 2.0	1.35	
TCV_{OS}	Input Offset Voltage Drift		2.5	10	10		$\mu\text{V}/^\circ\text{C}$
R_{IN}	Input Resistance		>1				Tera Ω
CMRR	Common Mode Rejection Ratio	$0V \leq V_{CM} \leq 7.5V$ $V^+ = 10V$	83	75 72	72 68	66 63	dB min
+ PSRR	Positive Power Supply Rejection Ratio	$5V \leq V^+ \leq 15V$	83	73 70	66 63	66 63	
- PSRR	Negative Power Supply Rejection Ratio	$0V \geq V^- \geq -10V$	94	80 77	74 71	74 71	
A_V	Large Signal Voltage Gain	Sourcing, $R_L = 2\text{ k}\Omega$ (Note 6)	1400	400 300	300 200	300 200	V/mV min
		Sinking, $R_L = 2\text{ k}\Omega$ (Note 6)	350	180 100	90 60	90 60	

DC Electrical Characteristics

Limits in standard typeface guaranteed for $T_J = 25^\circ\text{C}$ and limits in **boldface type** apply at the temperature extremes. Unless otherwise specified, $V^+ = 5\text{V}$, $V^- = 0\text{V}$, $V_{\text{CM}} = 1.5\text{V}$, and $R_L > 1\text{M}$. (Continued)

Symbol	Parameter	Conditions	Typical (Note 4)	Limits (Note 5)			Units
				LM6001AI	LM6001BI	LM6001CI	
V_{CM}	Input Common-Mode Voltage	$V^+ = 5\text{V}$ and 15V For $\text{CMRR} \geq 60\text{ dB}$	-0.4	-0.1 0	-0.1 0	-0.1 0	V max
			$V^+ - 1.9$	$V^+ - 2.3$ $V^+ - 2.5$	$V^+ - 2.3$ $V^+ - 2.5$	$V^+ - 2.3$ $V^+ - 2.5$	V min
V_O	Output Swing	$V^+ = 5\text{V}$ $R_L = 2\text{ k}\Omega$ to 2.5V	4.87	4.80 4.73	4.75 4.67	4.75 4.67	V min
			0.10	0.14 0.17	0.20 0.24	0.20 0.24	V max
		$V^+ = 15\text{V}$ $R_L = 2\text{ k}\Omega$ to 7.5V	14.63	14.50 14.34	14.37 14.25	14.37 14.25	V min
			0.26	0.35 0.45	0.44 0.56	0.44 0.56	V max
I_O	Output Current	Sourcing, $V^+ = 5\text{V}$, $V_O = 0\text{V}$	22	16 10	13 8	13 8	mA min
		Sinking, $V^+ = 5\text{V}$, $V_O = 5\text{V}$	21	16 13	13 10	13 10	
		Sourcing, $V^+ = 15\text{V}$, $V_O = 0\text{V}$	30	28 22	23 18	23 18	
		Sinking, $V^+ = 15\text{V}$, $V_O = 13\text{V}$ (Note 10)	34	28 22	23 18	23 18	
I_S	Supply Current	$V^+ = 5\text{V}$, $V_O = 1.5\text{V}$	450	750 900	750 900	750 900	μA max
		$V^+ = 15\text{V}$, $V_O = 7.5\text{V}$	550	850 950	850 950	850 950	

AC Electrical Characteristics

Limits in standard typeface guaranteed for $T_J = 25^\circ\text{C}$ and limits in **boldface type** apply at the temperature extremes. Unless otherwise specified, $V^+ = 5\text{V}$, $V^- = 0\text{V}$, $V_{\text{CM}} = 1.5\text{V}$ and $R_L > 1\text{M}$.

Symbol	Parameter	Conditions	Typical (Note 4)	Limits (Note 5)			Units
				LM6001AI	LM6001BI	LM6001CI	
SR	Slew Rate	(Note 7)	1.5	0.8 0.6	0.8 0.6	0.8 0.6	$\text{V}/\mu\text{s}$ min
GBW	Gain-Bandwidth Product		1.3				MHz
ϕ_{f_m}	Phase Margin		50				Deg
G_M	Gain Margin		17				dB
e_n	Input-Referred Voltage Noise	$F = 1\text{ kHz}$	22				$\text{nV}/\sqrt{\text{Hz}}$
i_n	Input-Referred Current Noise	$F = 1\text{ kHz}$	0.13				$\text{fA}/\sqrt{\text{Hz}}$
THD	Total Harmonic Distortion	$F = 10\text{ kHz}$, $A_V = -10$, $R_L = 100\text{ k}\Omega$, $V_O = 8\text{ V}_{\text{PP}}$	0.01				%

Note 1: Absolute Maximum Ratings indicate limits beyond which damage to the device may occur. Operating Ratings indicate conditions for which the device is intended to be functional but do not guarantee specific performance limits. For guaranteed specifications and test conditions, see the Electrical Characteristics. The guaranteed specifications apply only for the test conditions listed.

Note 2: Applies to both single supply and split supply operation. Continuous short circuit operation at elevated ambient temperature can result in exceeding the maximum allowed junction temperature of 150°C . Output currents in excess of $\pm 30\text{ mA}$ over long term may adversely affect reliability.

Note 3: The maximum power dissipation is a function of $T_{\text{J}(\text{max})}$, θ_{JA} , and T_A . The maximum allowable power dissipation at any ambient temperature is $P_D = (T_{\text{J}(\text{max})} - T_A)/\theta_{\text{JA}}$.

Note 4: Typical values represent the most likely parametric norm.

Note 5: All limits are guaranteed by testing or statistical analysis.

Note 6: $V^+ = 15\text{V}$, $V_{\text{CM}} = 7.5\text{V}$ and R_L connected to 7.5V . For Sourcing tests, $7.5\text{V} \leq V_O \leq 11.5\text{V}$. For Sinking tests, $2.5\text{V} \leq V_O \leq 7.5\text{V}$.

Note 7: $V^+ = 15\text{V}$. Connected as Voltage Follower with 10V step input. Limit specified is the lower of the positive and negative slew rates.

Note 8: For operating at elevated temperatures the device must be derated based on the thermal resistance θ_{JA} with $P_D = (T_J - T_A)/\theta_{\text{JA}}$.

Note 9: Human body model, $1.5\text{ k}\Omega$ in series with 100 pF .

Note 10: Do not connect the output to V^+ , when V^+ is greater than 13V or reliability will be adversely affected.

Note 11: All numbers apply for packages soldered directly into a printed circuit board.

Typical Performance Characteristics $V_S = \pm 7.5V$, $T_A = 25^\circ C$, unless otherwise specified

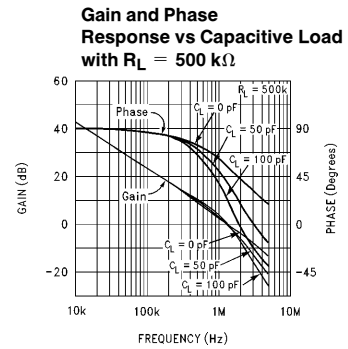
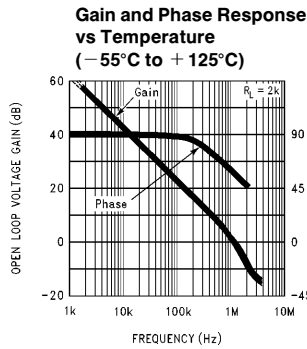
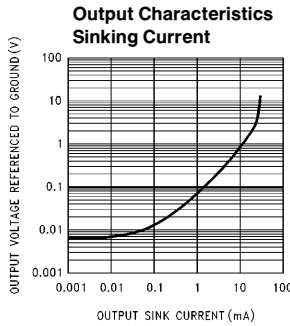
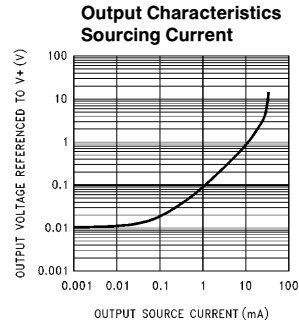
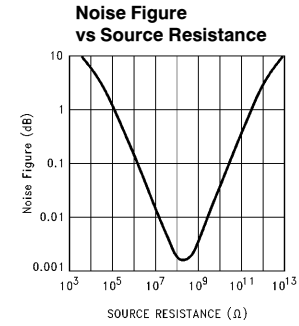
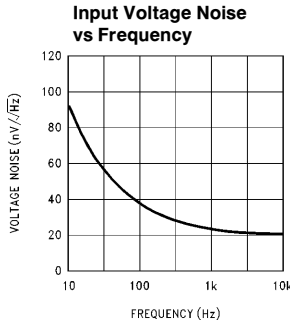
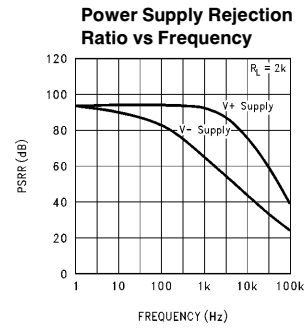
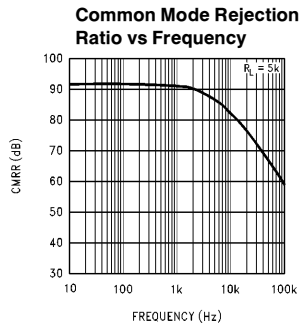
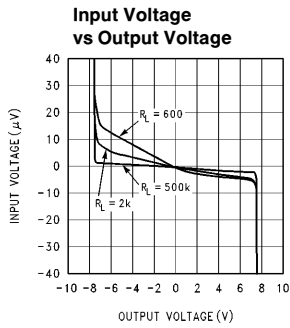
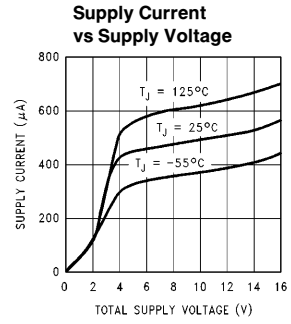
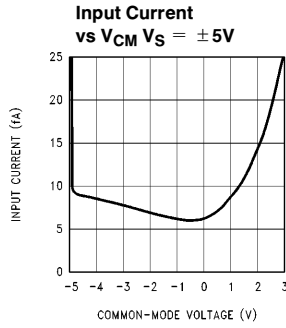
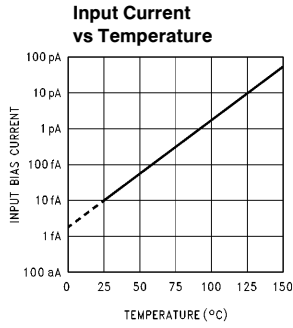

TL/H/11887-3

Typical Performance Characteristics $V_S = \pm 7.5V$, $T_A = 25^\circ C$, unless otherwise specified

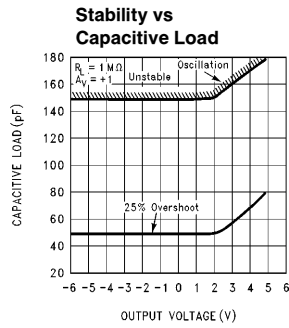
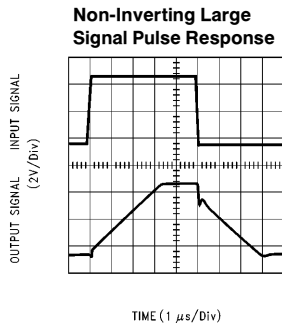
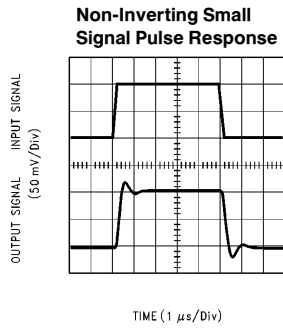
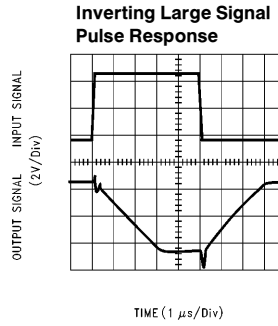
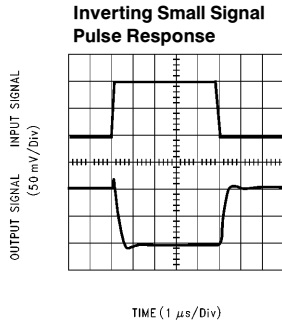
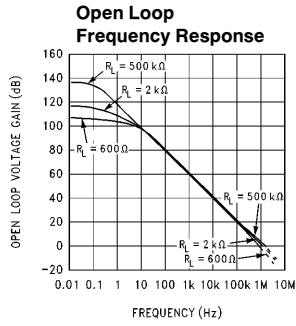

TL/H/11887-4

Applications Hints

AMPLIFIER TOPOLOGY

The LMC6001 incorporates a novel op-amp design topology that enables it to maintain rail-to-rail output swing even when driving a large load. Instead of relying on a push-pull unity gain output buffer stage, the output stage is taken directly from the internal integrator, which provides both low output impedance and large gain. Special feed-forward compensation design techniques are incorporated to maintain stability over a wider range of operating conditions than traditional op-amps. These features make the LMC6001 both easier to design with, and provide higher speed than products typically found in this low power class.

COMPENSATING FOR INPUT CAPACITANCE

It is quite common to use large values of feedback resistance for amplifiers with ultra-low input current, like the LMC6001.

Although the LMC6001 is highly stable over a wide range of operating conditions, certain precautions must be met to achieve the desired pulse response when a large feedback resistor is used. Large feedback resistors with even small values of input capacitance, due to transducers, photodiodes, and circuit board parasitics, reduce phase margins.

When high input impedances are demanded, guarding of the LMC6001 is suggested. Guarding input lines will not only reduce leakage, but lowers stray input capacitance as well. (See *Printed-Circuit-Board Layout for High Impedance Work*).

The effect of input capacitance can be compensated for by adding a capacitor, C_f , around the feedback resistors (as in *Figure 1*) such that:

$$\frac{1}{2\pi R_1 C_{IN}} \geq \frac{1}{2\pi R_2 C_f}$$

or

$$R_1 C_{IN} \leq R_2 C_f$$

Since it is often difficult to know the exact value of C_{IN} , C_f can be experimentally adjusted so that the desired pulse response is achieved. Refer to the LMC660 and LMC662 for a more detailed discussion on compensating for input capacitance.

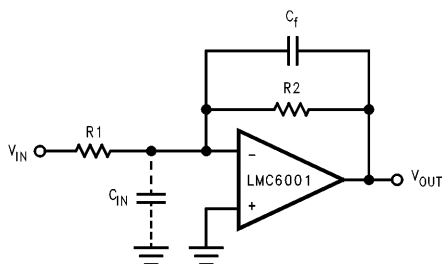

TL/H/11887-5

FIGURE 1. Cancelling the Effect of Input Capacitance

CAPACITIVE LOAD TOLERANCE

All rail-to-rail output swing operational amplifiers have voltage gain in the output stage. A compensation capacitor is normally included in this integrator stage. The frequency location of the dominant pole is affected by the resistive load on the amplifier. Capacitive load driving capability can be optimized by using an appropriate resistive load in parallel with the capacitive load (see *Typical Curves*).

Direct capacitive loading will reduce the phase margin of many op-amps. A pole in the feedback loop is created by the combination of the op-amp's output impedance and the capacitive load. This pole induces phase lag at the unity-gain crossover frequency of the amplifier resulting in either an oscillatory or underdamped pulse response. With a few external components, op amps can easily indirectly drive capacitive loads, as shown in *Figure 2a*.

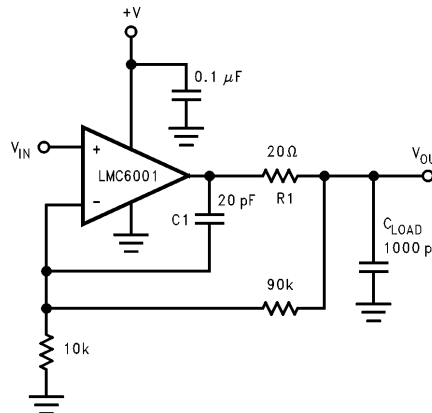

TL/H/11887-6

FIGURE 2a. LMC6001 Noninverting Gain of 10 Amplifier, Compensated to Handle Capacitive Loads

In the circuit of *Figure 2a*, R_1 and C_1 serve to counteract the loss of phase margin by feeding the high frequency component of the output signal back to the amplifier's inverting input, thereby preserving phase margin in the overall feedback loop.

Capacitive load driving capability is enhanced by using a pullup resistor to V^+ (*Figure 2b*). Typically a pullup resistor conducting $500 \mu A$ or more will significantly improve capacitive load responses. The value of the pullup resistor must be determined based on the current sinking capability of the amplifier with respect to the desired output swing. Open loop gain of the amplifier can also be affected by the pullup resistor (see *Electrical Characteristics*).

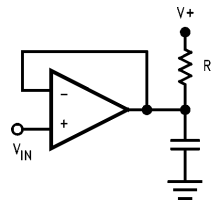

TL/H/11887-7

FIGURE 2b. Compensating for Large Capacitive Loads with a Pullup Resistor

PRINTED-CIRCUIT-BOARD LAYOUT FOR HIGH-IMPEDANCE WORK

It is generally recognized that any circuit which must operate with less than 1000 pA of leakage current requires special layout of the PC board. When one wishes to take advantage of the ultra-low bias current of the LMC6001, typically less than 10 fA , it is essential to have an excellent layout. Fortunately, the techniques of obtaining low leakages are quite simple. First, the user must not ignore the surface

Applications Hints (Continued)

leakage of the PC board, even though it may sometimes appear acceptably low, because under conditions of high humidity or dust or contamination, the surface leakage will be appreciable.

To minimize the effect of any surface leakage, lay out a ring of foil completely surrounding the LMC6001's inputs and the terminals of capacitors, diodes, conductors, resistors, relay terminals, etc., connected to the op-amp's inputs, as in *Figure 3*. To have a significant effect, guard rings should be placed on both the top and bottom of the PC board. This PC foil must then be connected to a voltage which is at the same voltage as the amplifier inputs, since no leakage current can flow between two points at the same potential. For example, a PC board trace-to-pad resistance of $10^{12}\Omega$, which is normally considered a very large resistance, could leak 5 pA if the trace were a 5V bus adjacent to the pad of the input.

This would cause a 500 times degradation from the LMC6001's actual performance. If a guard ring is used and held within 1 mV of the inputs, then the same resistance of $10^{12}\Omega$ will only cause 10 fA of leakage current. Even this small amount of leakage will degrade the extremely low input current performance of the LMC6001. See *Figures 4a, 4b, 4c* for typical connections of guard rings for standard op-amp configurations.

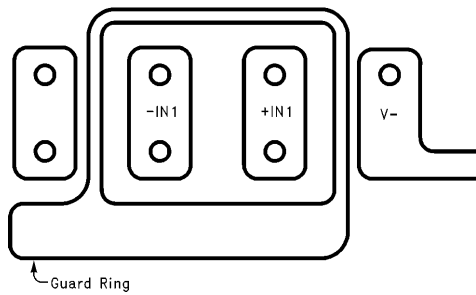
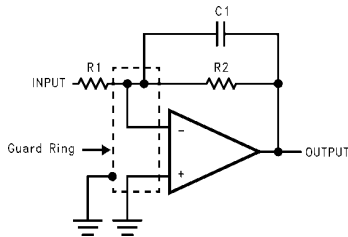

FIGURE 3. Examples of Guard Ring in PC Board Layout

TL/H/11887-8



(a) Inverting Amplifier

TL/H/11887-9

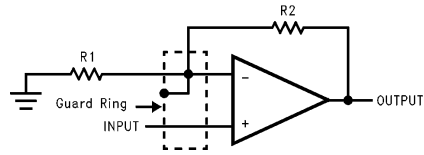

(b) Non-Inverting Amplifier

TL/H/11887-10

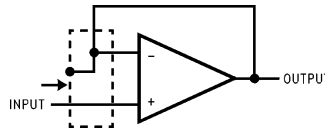

(c) Follower

TL/H/11887-11

FIGURE 4. Typical Connections of Guard Rings

The designer should be aware that when it is inappropriate to lay out a PC board for the sake of just a few circuits, there is another technique which is even better than a guard ring on a PC board: Don't insert the amplifier's input pin into the board at all, but bend it up in the air and use only air as an insulator. Air is an excellent insulator. In this case you may have to forego some of the advantages of PC board construction, but the advantages are sometimes well worth the effort of using point-to-point up-in-the-air wiring. See *Figure 5*.

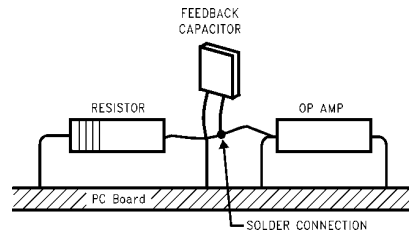

TL/H/11887-12

(Input pins are lifted out of PC board and soldered directly to components. All other pins connected to PC board).

FIGURE 5. Air Wiring

Another potential source of leakage that might be overlooked is the device package. When the LMC6001 is manufactured, the device is always handled with conductive finger cots. This is to assure that salts and skin oils do not cause leakage paths on the surface of the package. We recommend that these same precautions be adhered to, during all phases of inspection, test and assembly.

Latchup

CMOS devices tend to be susceptible to latchup due to their internal parasitic SCR effects. The (I/O) input and output pins look similar to the gate of the SCR. There is a minimum current required to trigger the SCR gate lead. The LMC6001 is designed to withstand 100 mA surge current on the I/O pins. Some resistive method should be used to isolate any capacitance from supplying excess current to the I/O pins. In addition, like an SCR, there is a minimum holding current for any latchup mode. Limiting current to the supply pins will also inhibit latchup susceptibility.

Typical Applications

The extremely high input resistance, and low power consumption, of the LMC6001 make it ideal for applications that require battery-powered instrumentation amplifiers. Examples of these types of applications are hand-held pH probes, analytic medical instruments, electrostatic field detectors and gas chromatographs.

Two Opamp, Temperature Compensated pH Probe Amplifier

The signal from a pH probe has a typical resistance between 10 M Ω and 1000 M Ω . Because of this high value, it is very important that the amplifier input currents be as small as possible. The LMC6001 with less than 25 fA input current is an ideal choice for this application.

The theoretical output of the standard Ag/AgCl pH probe is 59.16 mV/pH at 25°C with 0V out at a pH of 7.00. This output is proportional to absolute temperature. To compensate for this, a temperature compensating resistor, R1, is

placed in the feedback loop. This cancels the temperature dependence of the probe. This resistor must be mounted where it will be at the same temperature as the liquid being measured.

The LMC6001 amplifies the probe output providing a scaled voltage of ± 100 mV/pH from a pH of 7. The second opamp, a micropower LMC6041 provides phase inversion and offset so that the output is directly proportional to pH, over the full range of the probe. The pH reading can now be directly displayed on a low cost, low power digital panel meter. Total current consumption will be about 1 mA for the whole system.

The micropower dual operational amplifier, LMC6042, would optimize power consumption but not offer these advantages:

1. The LMC6001A guarantees a 25 fA limit on input current at 25°C.
2. The input ESD protection diodes in the LMC6042 are only rated at 500V while the LMC6001 has much more robust protection that is rated at 2000V.

The setup and calibration is simple with no interactions to cause problems.

1. Disconnect the pH probe and with R3 set to about mid-range and the noninverting input of the LMC6001 grounded, adjust R8 until the output is 700 mV.
2. Apply -414.1 mV to the noninverting input of the LMC6001. Adjust R3 for an output of 1400 mV. This completes the calibration. As real pH probes may not perform exactly to theory, minor gain and offset adjustments should be made by trimming while measuring a precision buffer solution.

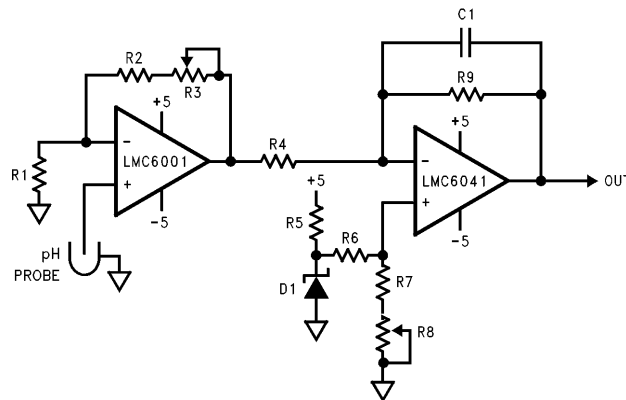

- R1 100k + 3500 ppm/°C*
- R2 68.1k
- R3, 8 5k
- R4, 9 100k
- R5 36.5k
- R6 619k
- R7 97.6k
- D1 LM4040D1Z-2.5
- C1 2.2 μ F

*(Micro-ohm style 144 or similar)

FIGURE 6. pH Probe Amplifier

TL/H/11887-15

Ultra-Low Input Current Instrumentation Amplifier

Figure 7 shows an instrumentation amplifier that features high differential and common mode input resistance ($> 10^{14}\Omega$), 0.01% gain accuracy at $A_V = 1000$, excellent CMRR with 1 M Ω imbalance in source resistance. Input current is less than 20 fA and offset drift is less than 2.5 $\mu\text{V}/^\circ\text{C}$.

R_2 provides a simple means of adjusting gain over a wide range without degrading CMRR. R_7 is an initial trim used to maximize CMRR without using super precision matched resistors. For good CMRR over temperature, low drift resistors should be used.

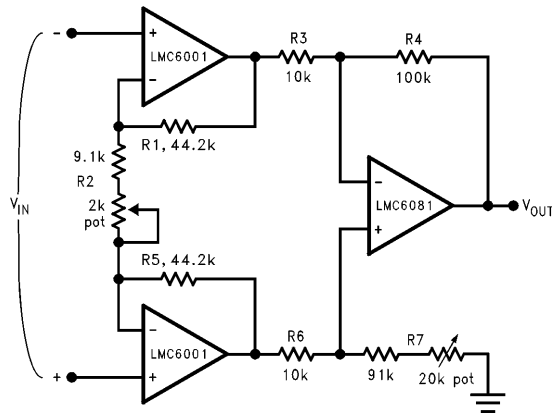

TL/H/11887-13

If $R_1 = R_5$, $R_3 = R_6$, and $R_4 = R_7$; then

$$\frac{V_{OUT}}{V_{IN}} = \frac{R_2 + 2R_1}{R_2} \times \frac{R_4}{R_3}$$

$\therefore A_V \approx 100$ for circuit shown ($R_2 = 9.85\text{k}$).

FIGURE 7. Instrumentation Amplifier

Physical Dimensions inches (millimeters)

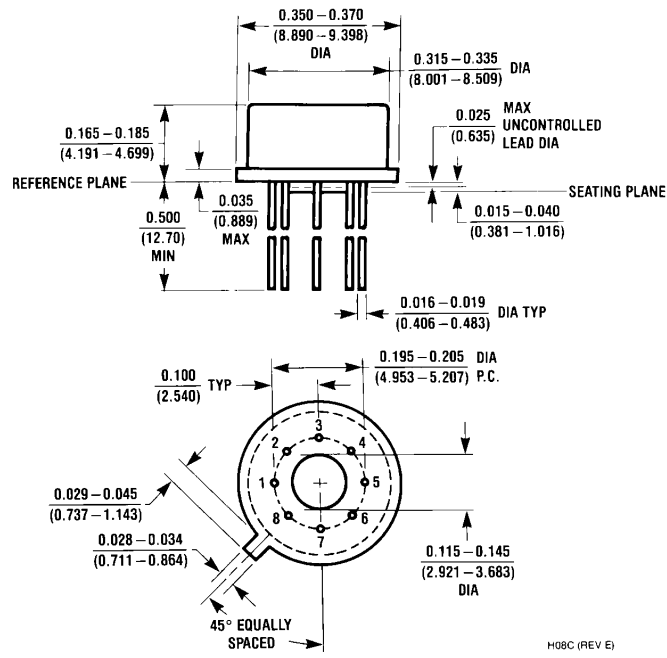

H08C (REV E)

8-Pin Metal Can Package (H)
Order Number LMC6001AIH or LMC6001BIH
NS Package Number H08C

Physical Dimensions inches (millimeters) (Continued)

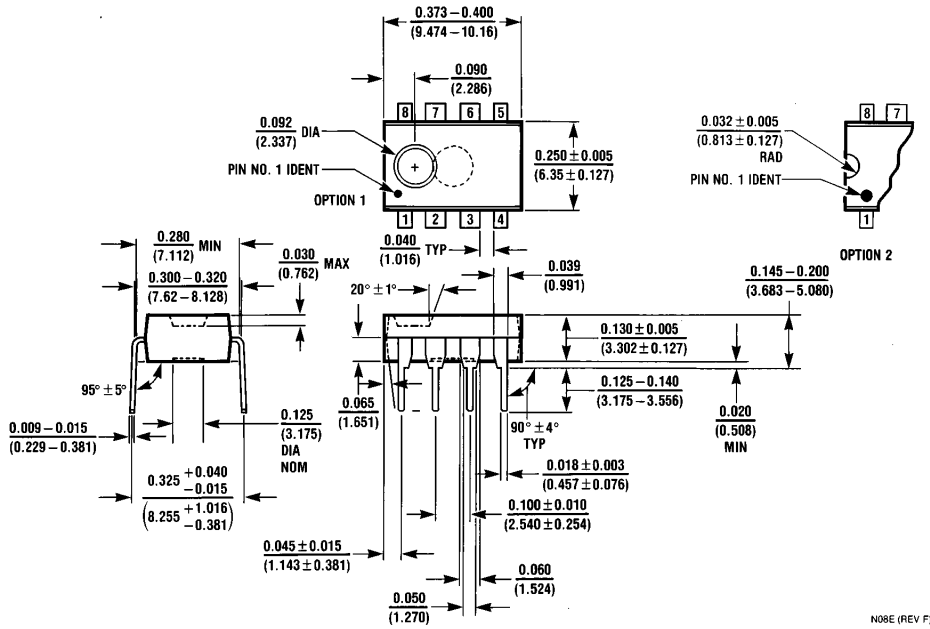

8-Pin Molded Dual-In-Line Package
Order Number LMC6001AIN, LMC6001BIN or LMC6001CIN
NS Package Number N08E

N08E (REV F)

LIFE SUPPORT POLICY

NATIONAL'S PRODUCTS ARE NOT AUTHORIZED FOR USE AS CRITICAL COMPONENTS IN LIFE SUPPORT DEVICES OR SYSTEMS WITHOUT THE EXPRESS WRITTEN APPROVAL OF THE PRESIDENT OF NATIONAL SEMICONDUCTOR CORPORATION. As used herein:

1. Life support devices or systems are devices or systems which, (a) are intended for surgical implant into the body, or (b) support or sustain life, and whose failure to perform, when properly used in accordance with instructions for use provided in the labeling, can be reasonably expected to result in a significant injury to the user.
2. A critical component is any component of a life support device or system whose failure to perform can be reasonably expected to cause the failure of the life support device or system, or to affect its safety or effectiveness.



National Semiconductor Corporation
 1111 West Bardin Road
 Arlington, TX 76017
 Tel: 1(800) 272-9959
 Fax: 1(800) 737-7018

National Semiconductor Europe
 Fax: (+49) 0-180-530 85 86
 Email: cnjwge@tevm2.nsc.com
 Deutsch Tel: (+49) 0-180-530 85 85
 English Tel: (+49) 0-180-532 78 32
 Français Tel: (+49) 0-180-532 93 58
 Italiano Tel: (+49) 0-180-534 16 80

National Semiconductor Hong Kong Ltd.
 19th Floor, Straight Block,
 Ocean Centre, 5 Canton Rd.
 Tsimshatsui, Kowloon
 Hong Kong
 Tel: (852) 2737-1600
 Fax: (852) 2736-9960

National Semiconductor Japan Ltd.
 Tel: 81-043-299-2309
 Fax: 81-043-299-2408

National does not assume any responsibility for use of any circuitry described, no circuit patent licenses are implied and National reserves the right at any time without notice to change said circuitry and specifications.