



LM613A/LM613

Dual Operational Amplifiers, Dual Comparators, and Adjustable Reference

General Description

The operational amplifiers are a versatile common-mode-to-the-negative-supply ("single supply") type similar to the LM124 series, but with improved slew rate, improved power bandwidth, reduced cross-over distortion, and low supply current even when driven beyond output swing limits. The comparators are also a common-mode-to-the-negative-supply type, similar to the LM139 series. The op amps and comparators have lateral PNP input transistors which enable low input currents for large differential input voltages and swings above V^+ .

The voltage reference is a three-terminal shunt-type band-gap similar to the adjustable LM185 series, but with anode committed to the V^- terminal and improved voltage accuracy to $\pm 0.4\%$. Two resistors program the reference from 1.24V to 6.3V. The reference features operation over a shunt current range of $16 \mu\text{A}$ to 20 mA, low dynamic impedance, broad capacitive load range, and cathode terminal voltage ranging from a diode-drop below V^- to above V^+ .

As a member of National's new Super-Block™ family, the LM613 is a space-saving monolithic alternative to a multi-chip solution, offering a high level of integration without sacrificing performance.

Features (Guaranteed over temperature & supply)

OP AMPS AND COMPARATORS

- Low operating current 1000 μA
(op amps & comparators)
16 μA (reference)
- Large supply voltage range 4V to 36V
- Large output swing
(10 k Ω load) $(V^- + 1V)$ to $(V^+ - 1.8V)$
- Input common-mode range V^- to $(V^+ - 1.4V)$
- Wide differential input voltage $\pm 36V$

REFERENCE

- Adjustable output voltage 1.2V to 6.3V
- Tight initial tolerance available $\pm 0.4\%$
- Tolerant of load capacitance

Applications

- Power supplies
- Signal conditioning

Connection Diagram

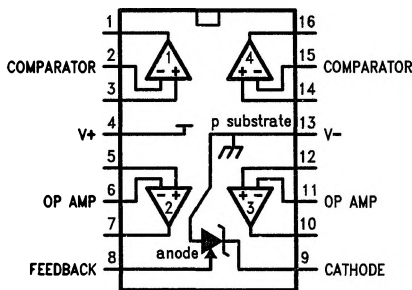

Top View

TL/H/9226-1

Order Number LM613IJ, LM613MJ, LM613CWM,
LM613IWM, LM613AIN, LM613CN or LM613IN
See NS Package Number J16A, M16B or N16A

Order Number

Prime Military	LM613MJ
Tested at -55°C , $+25^\circ\text{C}$, $+125^\circ\text{C}$	
Drift tested at -55°C , $+25^\circ\text{C}$, $+125^\circ\text{C}$	
Prime Industrial	LM613AIN
Tested at 25°C	
Drift tested at -40°C , $+25^\circ\text{C}$, $+85^\circ\text{C}$	
Industrial	LM613IN
Tested at $+25^\circ\text{C}$	
	LM613IJ
	LM613IWM
Commercial	LM613CN
Tested at $+25^\circ\text{C}$	
	LM613CWM

Packages

J	Hermetic Dual-In-Line
N	Plastic Dual-In-Line
WM	Plastic Surface Mount Wide (0.3")

Absolute Maximum Ratings (Note 1)

If Military/Aerospace specified devices are required, please contact the National Semiconductor Sales Office/Distributors for availability and specifications.

Voltage on Any Pin Except Cathode Pin (referred to V – pin) (Note 2)

(Note 3)	–0.3V (Min)
LM613M, LM613AI, LM613I	36V
LM613C	32V

Current through Any Input Pin & Cathode Pin ±20 mA

Differential Input Voltage	
LM613M, LM613AI, LM613I	±36V
LM613C	±32V

Short Circuit Duration, Op Amp (Note 4) Continuous

Storage Temperature Range –65°C to +150°C

Maximum Junction Temperature 150°C

Soldering Information

J, N Packages

Soldering (10 seconds) 260°C

WM Package

Vapor Phase (60 seconds) 215°C

Infrared (15 seconds) 220°C

See AN-450 "Surface Mounting Methods and Their Effect on Product Reliability" for other methods of soldering surface mount devices.

Thermal Resistance, Junction-to-Ambient (Note 5)

LM613MJ, LM613IJ 100 °C/W

LM613AI, LM613IN, LM613CN 95 °C/W

LM613IWM, LM613CWM 144 °C/W

ESD Tolerance (Note 6) ±1 kV

Operating Junction Temperature Range T_{MIN} to T_{MAX}

LM613M –55°C to +125°C

LM613I –40°C to +85°C

LM613C 0°C to +70°C

Electrical Characteristics These specifications apply for $V^- = GND = 0V$, $V^+ = 5V$, $V_{CM} = V_{OUT} = V^+ / 2$, $I_R = 100 \mu A$, FEEDBACK pin shorted to GND, unless otherwise specified. Limits in standard typeface are for $T_J = 25^\circ C$; limits in **boldface type** apply for T_{MIN} to T_{MAX} .

Parameter	Conditions	Typ (Note 7)	LM613M		LM613AI, LM613I		LM613C		Units
			Tested Limit (Note 8)	Design Limit (Note 9)	Tested Limit (Note 8)	Design Limit (Note 9)	Tested Limit (Note 8)	Design Limit (Note 9)	
Total Supply Current	V^+ Current, $R_{LOAD} = \infty$, $4V \leq V^+ \leq 36V$ (32V for LM613C)	450 550	900 1000		940	1000	1000	1070	μA (Max) μA (Max)
Supply Voltage Range	Total Supply Current Specification is Met	2.2	2.8		2.8	3	2.8	3	V (Min) V (Min)
		46	36		36	36	32	32	V (Max) V (Max)
		43	36						

OPERATIONAL AMPLIFIERS

Offset Voltage	$4V \leq V^+ \leq 36V$ (32V for LM613C)	±1.5	±3.5		±3.5		±5.0		mV (Max)
		±2.0	±5.0			±6.0		±7.0	mV (Max)
Offset Voltage over V_{CM}	$0V \leq V_{CM} \leq (V^+ - 1.4V)$, $V^+ = 30V$	±1.0	±3.5		±3.5		±5.0		mV (Max)
		±1.5	±5.0			±6.0		±7.0	mV (Max)
Average Offset Voltage Drift	LM613M and LM613AI Op Amp 3 Only, (Note 10)	15	25		30				$\mu V/^\circ C$ (Max)
Input Bias Current		–10	±20		±25		±35		nA (Max)
		–11	±25			±30		±40	nA (Max)
Input Offset Current		±0.2	±4		±4		±4		nA (Max)
		±0.3	±4			±5		±5	nA (Max)
Average Offset Current Drift		±4							pA/°C
Input Resistance		>1000							M Ω
Input Capacitance	Differential	0.6							pF
	Non-Inv. Input to GND	6							pF

Electrical Characteristics These specifications apply for $V^- = \text{GND} = 0\text{V}$, $V^+ = 5\text{V}$, $V_{\text{CM}} = V_{\text{OUT}} = V^+ / 2$, $I_{\text{R}} = 100 \mu\text{A}$, FEEDBACK pin shorted to GND, unless otherwise specified. Limits in standard typeface are for $T_{\text{J}} = 25^\circ\text{C}$; limits in **boldface type** apply for T_{MIN} to T_{MAX} . (Continued)

Parameter	Conditions	Typ (Note 7)	LM613M		LM613AI, LM613I		LM613C		Units
			Tested Limit (Note 8)	Design Limit (Note 9)	Tested Limit (Note 8)	Design Limit (Note 9)	Tested Limit (Note 8)	Design Limit (Note 9)	
OPERATIONAL AMPLIFIERS (Continued)									
Voltage Noise	$f = 100 \text{ Hz}$	74							nV/ $\sqrt{\text{Hz}}$
Current Noise	$f = 100 \text{ Hz}$	58							fA/ $\sqrt{\text{Hz}}$
Common-Mode Rejection Ratio	$0\text{V} \leq V_{\text{CM}} \leq (V^+ - 1.4\text{V})$, $V^+ = 30\text{V}$	95 90	85 80		80	75	75	70	dB (Min) dB (Min)
Power Supply Rejection Ratio	$4\text{V} \leq V^+ \leq 30\text{V}$, $V_{\text{CM}} = V^+ / 2$	100 90	85 80		80	75	75	70	dB (Min) dB (Min)
Voltage Gain, Open Loop	$R_{\text{L}} = 10 \text{ k}\Omega$ to GND, $V^+ = 30\text{V}$ $5\text{V} \leq V_{\text{OUT}} \leq 25\text{V}$	500 50	100 40		100	40	94	40	V/mV (Min)
Slew Rate	$V^+ = 30\text{V}$ (Note 11)	± 0.70 ± 0.65	± 0.55 ± 0.45		± 0.55	± 0.45	± 0.50	± 0.45	V/ μs (Min)
Gain-Bandwidth Product	$C_{\text{L}} = 50 \text{ pF}$	0.8 0.5							MHz MHz
Output Voltage Swing	$R_{\text{L}} = 10 \text{ k}\Omega$ to GND, $V^+ = 36\text{V}$ (32V for LM613C)	$V^+ - 1.4$ $V^+ - 1.6$	$V^+ - 1.6$ $V^+ - 1.8$		$V^+ - 1.7$	$V^+ - 1.9$	$V^+ - 1.8$	$V^+ - 1.9$	V (Min) V (Min)
	$R_{\text{L}} = 10 \text{ k}\Omega$ to V^+ , $V^+ = 36\text{V}$ (32V for LM613C)	$V^- + 0.8$ $V^- + 0.9$	$V^- + 0.90$ $V^- + 1.0$		$V^- + 0.90$	$V^- + 1.0$	$V^- + 0.95$	$V^- + 1.0$	V (Max) V (Max)
Output Current (Sourcing)	$V_{\text{OUT}} = V^+ - 2.5\text{V}$, $V_{+\text{IN}} = 0\text{V}$ $V_{-\text{IN}} = -0.3\text{V}$	-25 -15	-20 -13		-20	-13	-16	-13	mA (Max) mA (Max)
	(Sinking)	$V_{\text{OUT}} = 1.6\text{V}$, $V_{+\text{IN}} = 0\text{V}$ $V_{-\text{IN}} = -0.3\text{V}$	17 9	15 8		14	11	13	11
Output Short- Circuit Current (Sourcing)	$V_{\text{OUT}} = 0\text{V}$, $V_{+\text{IN}} = 3\text{V}$ $V_{-\text{IN}} = 2\text{V}$	-30 -40	-37 -46		-40	-48	-43	-50	mA (Min) mA (Min)
	(Sinking)	$V_{\text{OUT}} = 5\text{V}$, $V_{+\text{IN}} = 2\text{V}$ $V_{-\text{IN}} = 3\text{V}$	30 32	40 60		60	80	70	90
COMPARATORS									
Offset Voltage	$4\text{V} \leq V^+ \leq 36\text{V}$ (32V for LM613C), $R_{\text{L}} = 15 \text{ k}\Omega$	± 1.0 ± 2.0	± 2.5 ± 4.0		± 3.0	± 6.0	± 5.0	± 7.0	mV (Max) mV (Max)
Offset Voltage over V_{CM}	$0\text{V} \leq V_{\text{CM}} (V^+ - 1.4\text{V})$, $V^+ = 30\text{V}$, $R_{\text{L}} = 15 \text{ k}\Omega$	± 1.0 ± 1.5	± 2.5 ± 4.0		± 3.0	± 6.0	± 5.0	± 7.0	mV (Max) mV (Max)
Average Offset Voltage Drift		15							$\mu\text{V}/^\circ\text{C}$ (Max)
Input Bias Current		-5 -8	± 20 ± 25		± 25	± 30	± 35	± 40	nA (Max) nA (Max)

Electrical Characteristics These specifications apply for $V^- = \text{GND} = 0\text{V}$, $V^+ = 5\text{V}$, $V_{\text{CM}} = V_{\text{OUT}} = V^+ / 2$, $I_{\text{R}} = 100 \mu\text{A}$, FEEDBACK pin shorted to GND, unless otherwise specified. Limits in standard typeface are for $T_{\text{J}} = 25^\circ\text{C}$; limits in **boldface type** apply for T_{MIN} to T_{MAX} . (Continued)

Parameter	Conditions	Typ (Note 7)	LM613M		LM613AI, LM613I		LM613C		Units
			Tested Limit (Note 8)	Design Limit (Note 9)	Tested Limit (Note 8)	Design Limit (Note 9)	Tested Limit (Note 8)	Design Limit (Note 9)	
COMPARATORS (Continued)									
Input Offset Current		± 0.2 ± 0.3	± 4 ± 4		± 4	± 5	± 4	± 5	nA (Max) nA (Max)
Voltage Gain	$R_{\text{L}} = 10 \text{ k}\Omega$ to 36V (32V for LM613C), $2\text{V} \leq V_{\text{OUT}} \leq 27\text{V}$	500 100							V/mV V/mV
Large Signal Response Time	$V_{+\text{IN}} = 1.4\text{V}$, $V_{-\text{IN}} = \text{TTL Swing}$, $R_{\text{L}} = 5.1 \text{ k}\Omega$	1.5 2.0							μs μs
Output Sink Current	$V_{+\text{IN}} = 0\text{V}$, $V_{-\text{IN}} = 1\text{V}$, $V_{\text{OUT}} = 1.5\text{V}$	20 13	12 8		10	8	10	8	mA (Min) mA (Min)
	$V_{\text{OUT}} = 0.4\text{V}$	2.8 2.4	1.0 0.8		1.0	0.5	0.8	0.5	mA (Min) mA (Min)
Output Leakage Current	$V_{+\text{IN}} = 1\text{V}$, $V_{-\text{IN}} = 0\text{V}$, $V_{\text{OUT}} = 36\text{V}$ (32V for LM613C)	0.1 0.2	10 10		10		10		μA (Max) μA (Max)
VOLTAGE REFERENCE (Note 12)									
Reference Voltage		1.244	1.2390 1.2490 ($\pm 0.4\%$)		1.2365 1.2515 ($\pm 0.6\%$)		1.2191 1.2689 ($\pm 2\%$)		V (Min) V (Max)
Average Temp. Drift	(Note 13) LM613AI	10	20		20	80		150	ppm/ $^\circ\text{C}$ (Max)
Average Time Drift	$T_{\text{J}} = 40^\circ\text{C}$ $T_{\text{J}} = 150^\circ\text{C}$	400 1000							ppm/kH ppm/kH
Hysteresis	(Note 14)	± 3.2							$\mu\text{V}/^\circ\text{C}$
V_{R} Change with Current	$V_{\text{R}[100 \mu\text{A}]} - V_{\text{R}[16 \mu\text{A}]}$	0.05 0.1	± 1 ± 1		± 1	± 1.1	± 1	± 1.1	mV (Max) mV (Max)
	$V_{\text{R}[10 \text{ mA}]} - V_{\text{R}[100 \mu\text{A}]}$ (Note 15)	1.5 2.0	5 5		5	5.5	5	5.5	mV (Max) mV (Max)
Resistance	$\Delta V_{\text{R}[10 \rightarrow 0.1 \text{ mA}]} / 9.9 \text{ mA}$	0.2		0.51		0.56		0.56	Ω (Max)
	$\Delta V_{\text{R}[100 \rightarrow 16 \mu\text{A}]} / 84 \mu\text{A}$	0.6		12		13		13	Ω (Max)
V_{R} Change with High V_{RO}	$V_{\text{R}[V_{\text{ro}} = V_{\text{I}}]} - V_{\text{R}[V_{\text{ro}} = 6.3\text{V}]}$ (5.06V between Anode and FEEDBACK)	2.5 2.8	5 8		7	10	7	10	mV (Max) mV (Max)
V_{R} Change with V^+ Change	$V_{\text{R}[V^+ = 5\text{V}]} - V_{\text{R}[V^+ = 36\text{V}]}$ ($V^+ = 32\text{V}$ for LM613C)	0.1 0.1	± 1.2 ± 1.2		± 1.2	± 1.3	± 1.2	± 1.3	mV (Max) mV (Max)
	$V_{\text{R}[V^+ = 5\text{V}]} - V_{\text{R}[V^+ = 3\text{V}]}$	0.01 0.01	± 1 ± 1		± 1	± 1.5	± 1	± 1.5	mV (Max) mV (Max)
FEEDBACK Bias Current	$V_{\text{ANODE}} \leq V_{\text{FB}} \leq 5.06\text{V}$	-22 -29	-35 -40		-35	-40	-50	-55	nA (Min) nA (Min)
Voltage Noise	$\text{BW} = 10 \text{ Hz}$ to 10 kHz , $V_{\text{RO}} = V_{\text{R}}$	30							μV_{RMS}

Electrical Characteristics (Continued)

Note 1: Absolute maximum ratings indicate limits beyond which damage to the component may occur. Electrical specifications do not apply when operating the device beyond its rated operating conditions.

Note 2: Input voltage above V^+ is allowed. As long as one input pin voltage remains inside the common-mode range, the comparator will deliver the correct output.

Note 3: More accurately, it is excessive current flow, with resulting excess heating, that limits the voltages on all pins. When any pin is pulled a diode drop below V^- , a parasitic NPN transistor turns ON. No latch-up will occur as long as the current through that pin remains below the Maximum Rating. Operation is undefined and unpredictable when any parasitic diode or transistor is conducting.

Note 4: Simultaneous short-circuit of multiple op amps or comparators while using high supply voltages may force junction temperature above maximum, and thus should not be continuous.

Note 5: Junction temperature may be calculated using $T_J = T_A + P_D \theta_{JA}$. The given thermal resistances are worst-case for packages in sockets in still air. Nominal θ_{JA} are 85°C/W for LM613 in J package, 80°C/W for the N package, and 135°C/W for the WM package, for packages soldered to copper-clad board with dissipation from one op amp, comparator, or reference output transistor.

Note 6: Human body model, 100 pF discharged through a 1.5 k Ω resistor.

Note 7: Typical values in standard typeface are for $T_J = 25^\circ\text{C}$; values in **boldface type** apply to the military temperature range. These values represent the most likely parametric norm.

Note 8: Tested limits are guaranteed and 100% tested.

Note 9: Design limits are guaranteed via correlation, but are not 100% tested.

Note 10: Offset voltage drift is calculated from the measurement of the offset voltage at 25°C and at the temperature extremes. The drift is $\Delta V_{OS}/\Delta T$, where ΔV_{OS} is the lowest value subtracted from the highest, and ΔT is the temperature range.

Note 11: Slew rate is measured with the op amp in a voltage follower configuration. For rising slew rate, the input voltage is driven from 5V to 25V, and the output voltage transition is sampled at 10V and 20V. For falling slew rate, the input voltage is driven from 25V to 5V, and the output voltage transition is sampled at 20V and 10V.

Note 12: V_{RO} is the Cathode-to-Anode voltage (i.e. the reference output voltage, 1.2V to 6.3V). V_R is the Cathode-to-FEEDBACK voltage (nominally 1.2V).

Note 13: Average reference drift is calculated from the measurement of the reference voltage at 25°C and at the temperature extremes. The drift, in ppm/°C, is $10^6 \cdot \Delta V_R / V_{R[25^\circ\text{C}]} \cdot \Delta T_J$, where ΔV_R is the lowest value subtracted from the highest, $V_{R[25^\circ\text{C}]}$ is the value at 25°C, and ΔT_J is the temperature range.

Note 14: Hysteresis is $\Delta V_{RO}/\Delta T_J$, where ΔV_{RO} is the change in V_{RO} caused by a change in T_J , after the reference has been "dehysterized". To dehysterize the reference, its junction temperature should be cycled in the following pattern, spiraling in toward 25°C: 25°C, 125°C, -55°C, 85°C, -40°C, 70°C, 0°C, 25°C.

Note 15: Low contact resistance is required for accurate measurement.

Simplified Schematic Diagrams

Op Amp

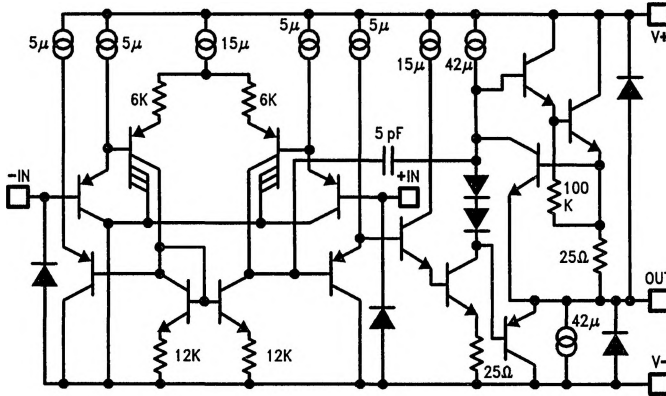

TL/H/9226-2

Comparator

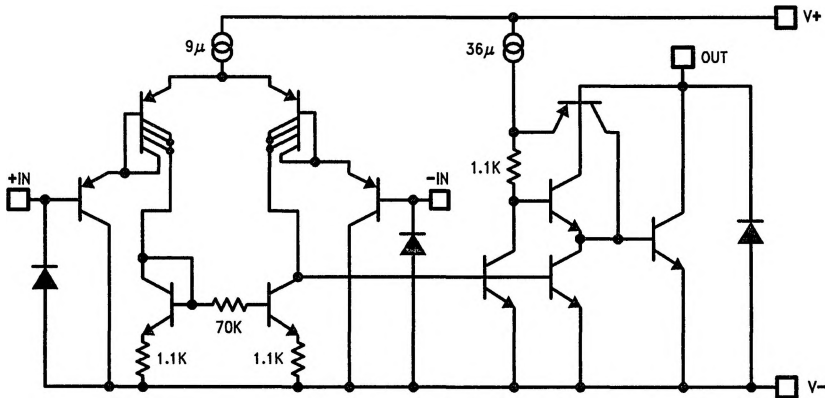

TL/H/9226-3

Reference

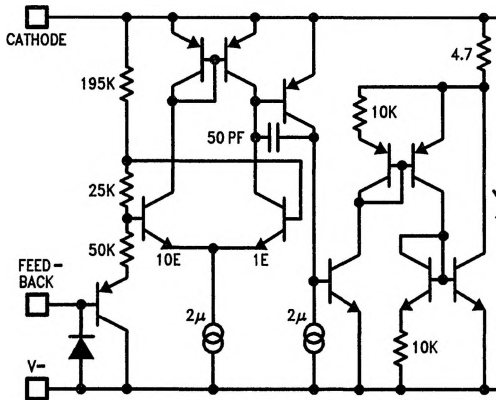

Bias

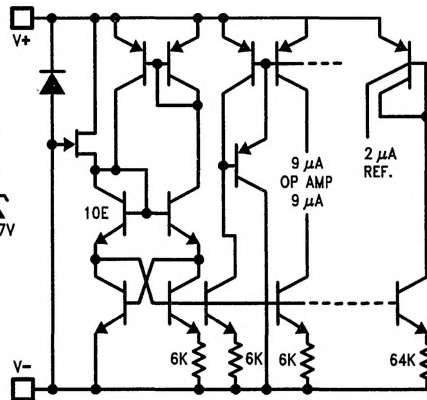

TL/H/9226-4

Typical Performance Characteristics (Reference)

$T_j = 25^\circ\text{C}$, FEEDBACK pin shorted to $V^- = 0\text{V}$, unless otherwise noted

Reference Voltage vs Temp.

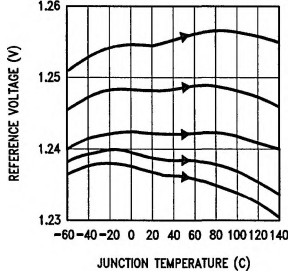

Reference Voltage Drift

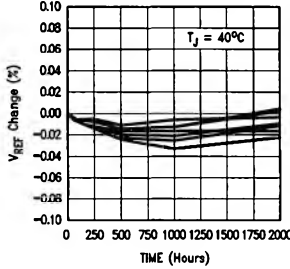

Accelerated Reference Voltage Drift vs Time

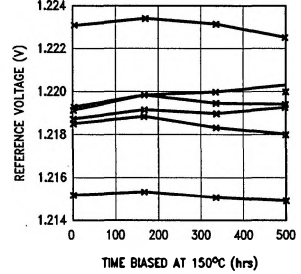

Reference Voltage vs Current and Temperature

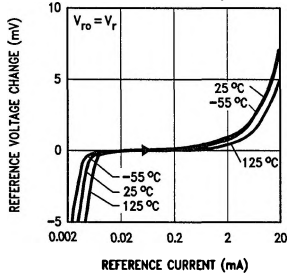

Reference Voltage vs Current and Temperature

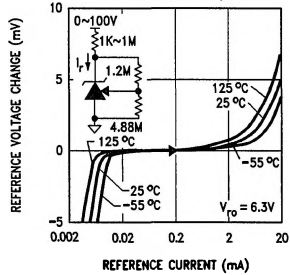

Reference Voltage vs Reference Current

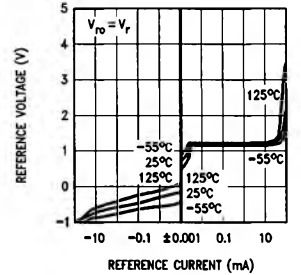

Reference Voltage vs Reference Current

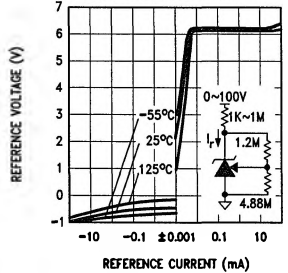

Reference AC Stability Range

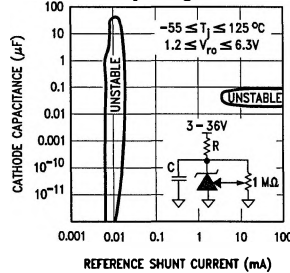

FEEDBACK Current vs FEEDBACK-to-Anode Voltage

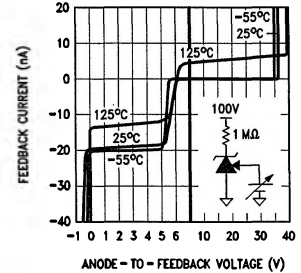

FEEDBACK Current vs FEEDBACK-to-Anode Voltage

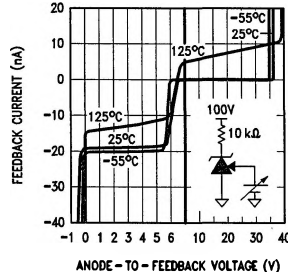

Reference Noise Voltage vs Frequency

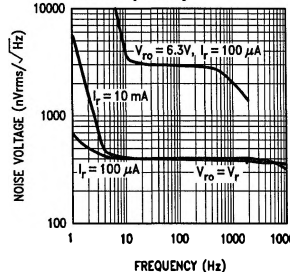

Reference Small-Signal Resistance vs Frequency

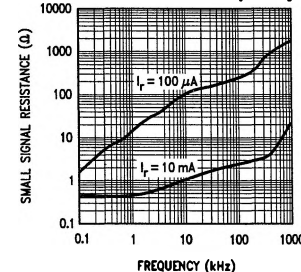

Typical Performance Characteristics (Reference) (Continued)

$T_J = 25^\circ\text{C}$, FEEDBACK pin shorted to $V^- = 0\text{V}$, unless otherwise noted

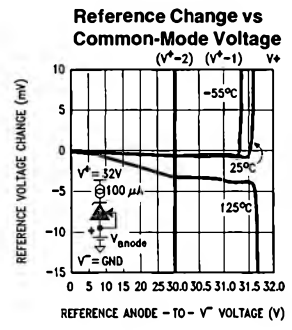
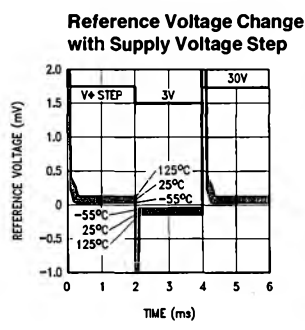
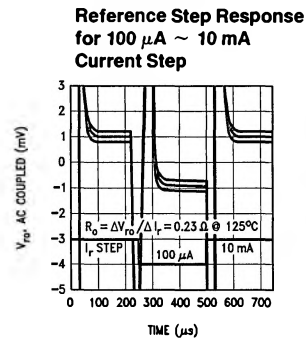
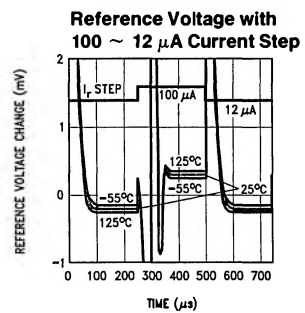
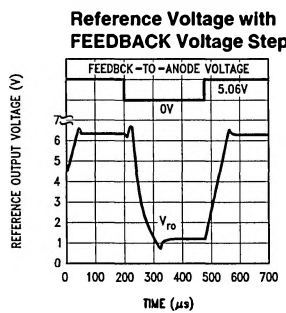
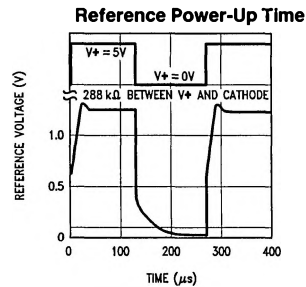

TL/H/9226-6

Typical Performance Characteristics (Op Amps)

$V^+ = 5\text{V}$, $V^- = \text{GND} = 0\text{V}$, $V_{CM} = V^+ / 2$, $V_{OUT} = V^+ / 2$, $T_J = 25^\circ\text{C}$, unless otherwise noted

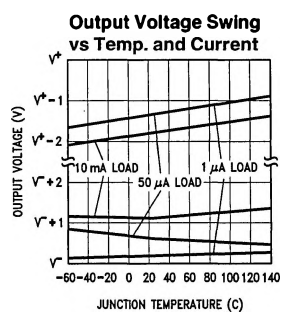
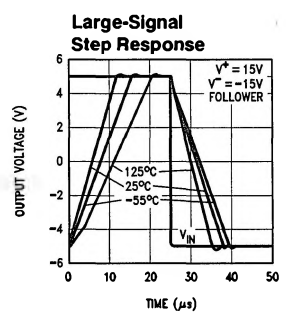
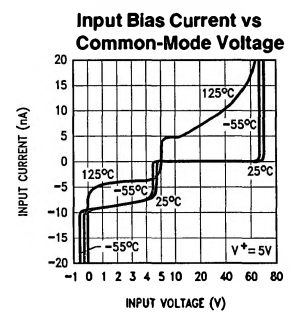
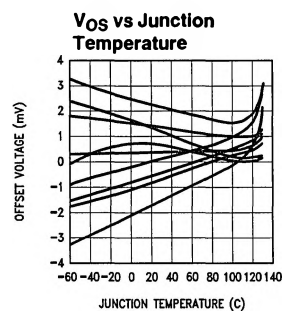
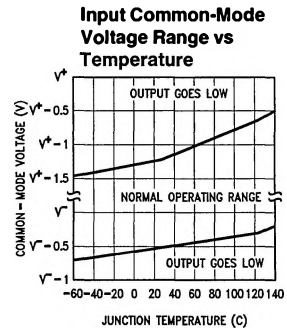

TL/H/9226-7

Typical Performance Characteristics (Op Amps) (Continued)

$V^+ = 5V, V^- = GND = 0V, V_{CM} = V^+/2, V_{OUT} = V^+/2, T_J = 25^\circ C$, unless otherwise noted

Output Source Current vs Output Voltage and Temp.

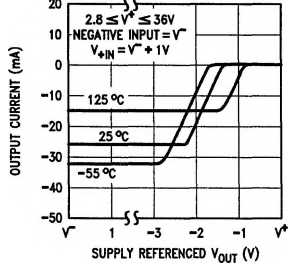

Output Sink Current vs Output Voltage

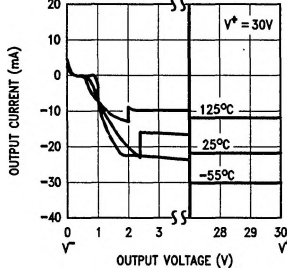

Output Swing, Large Signal

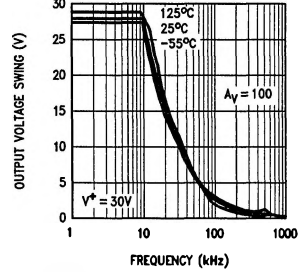

Output Impedance vs Frequency and Gain

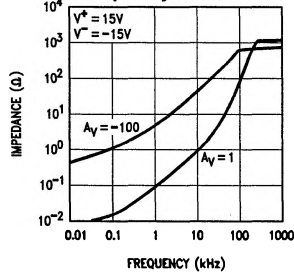

Small Signal Pulse Response vs Temp.

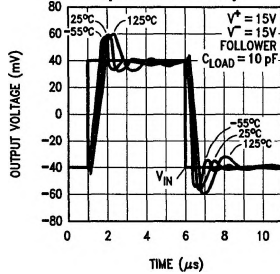

Small-Signal Pulse Response vs Load

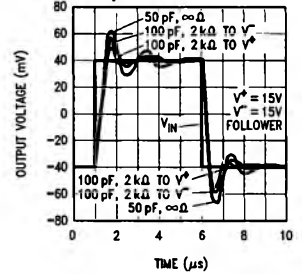

Op Amp Voltage Noise vs Frequency

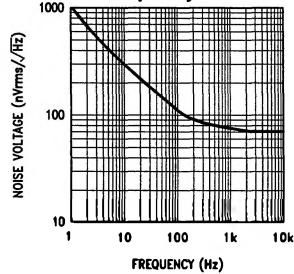

Op Amp Current Noise vs Frequency

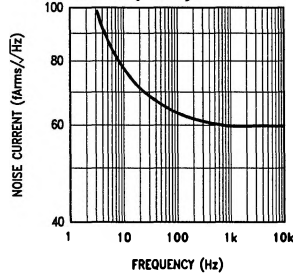

Small-Signal Voltage Gain vs Frequency and Temperature

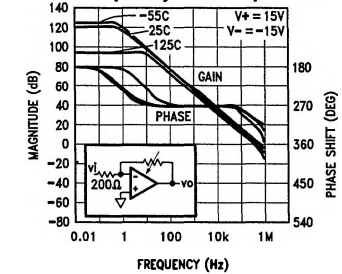

Small-Signal Voltage Gain vs Frequency and Load

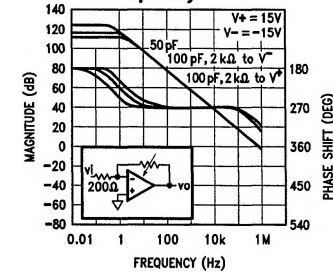

Follower Small-Signal Frequency Response

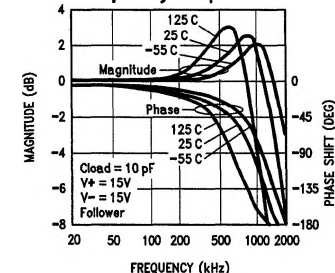

Common-Mode Input Voltage Rejection Ratio

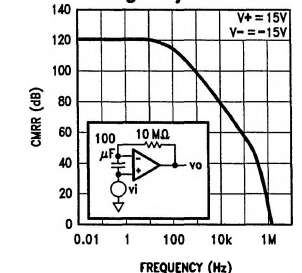

Typical Performance Characteristics (Op Amps) (Continued)

$V^+ = 5V, V^- = GND = 0V, V_{CM} = V^+ / 2, V_{OUT} = V^+ / 2, T_J = 25^\circ C$, unless otherwise noted

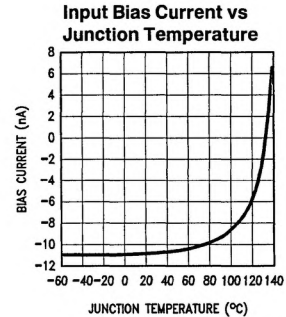
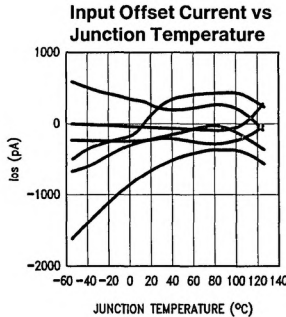
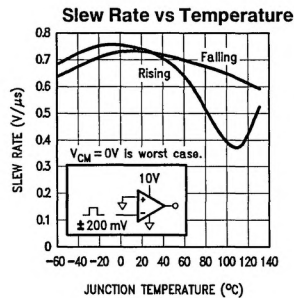
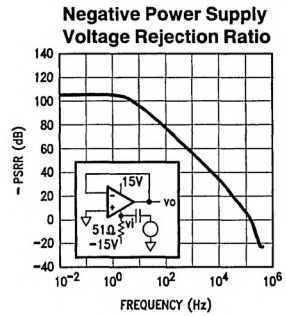
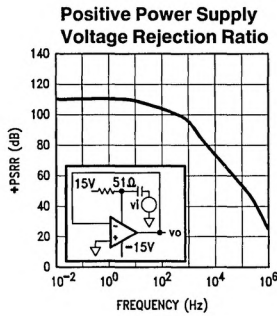
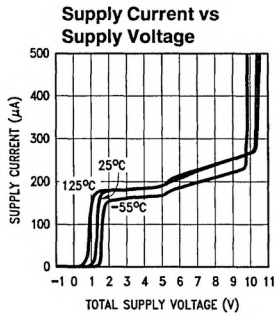

TL/H/9226-9

Typical Performance Characteristics (Comparators)

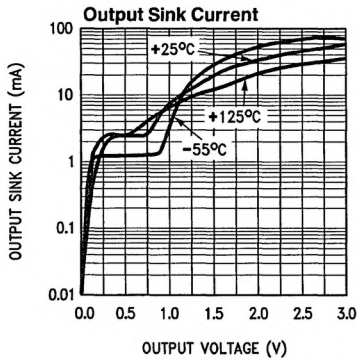

TL/H/9226-10

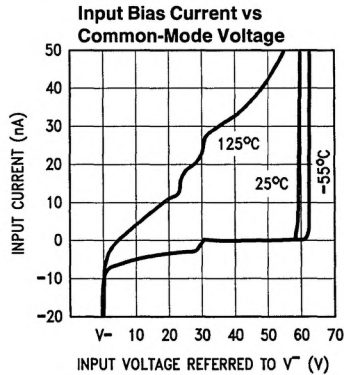

TL/H/9226-11

Typical Performance Characteristics (Comparators) (Continued)

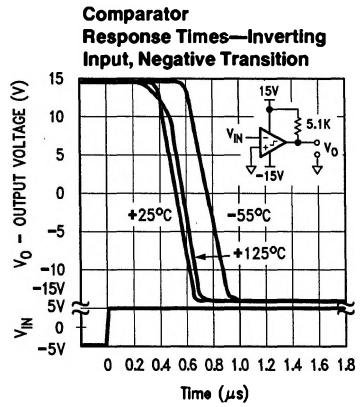
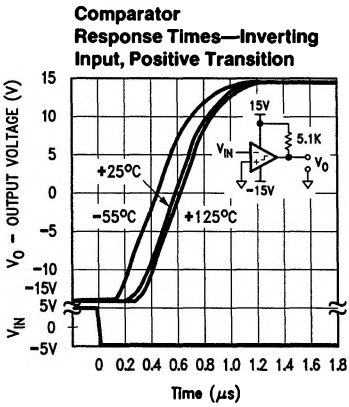
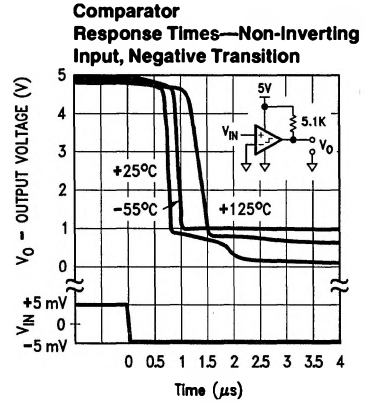
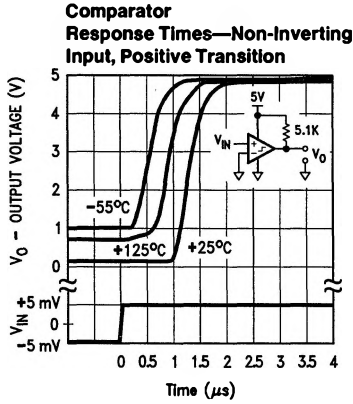
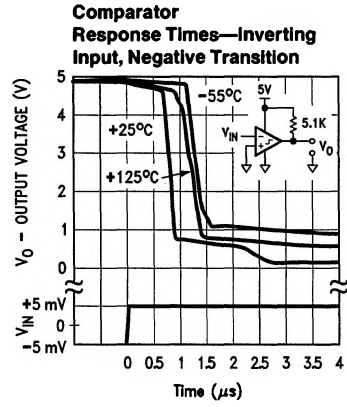
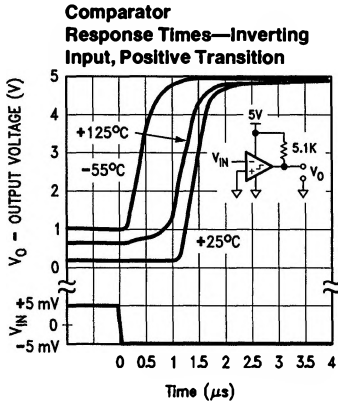

Typical Performance Characteristics (Comparators) (Continued)

Comparator Response Times—Non-Inverting Input, Positive Transition

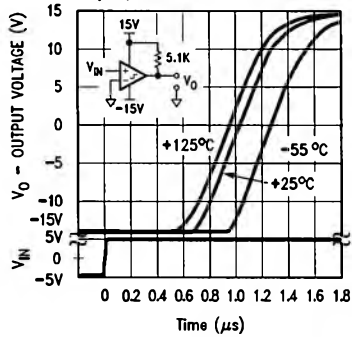

TL/H/9226-18

Comparator Response Times—Non-Inverting Input, Negative Transition

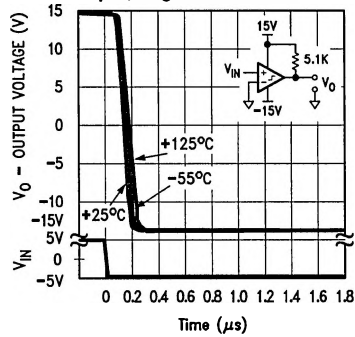

TL/H/9226-19

Typical Performance Distributions

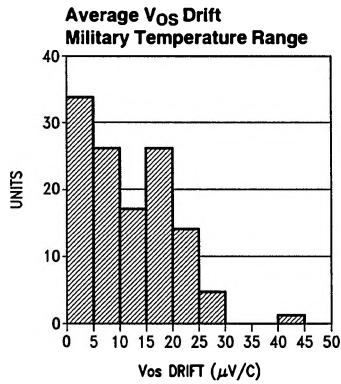

TL/H/9226-20

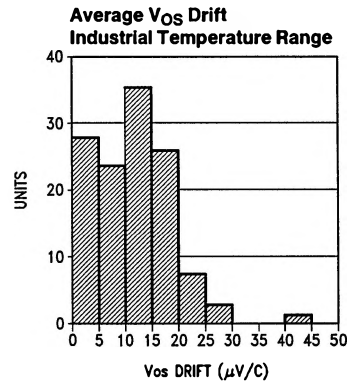

TL/H/9226-21

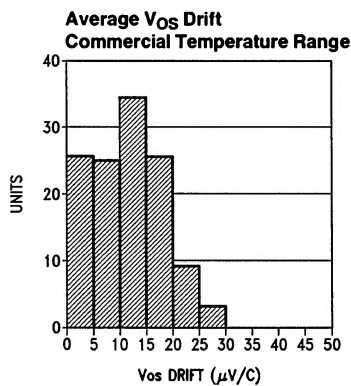

TL/H/9226-22

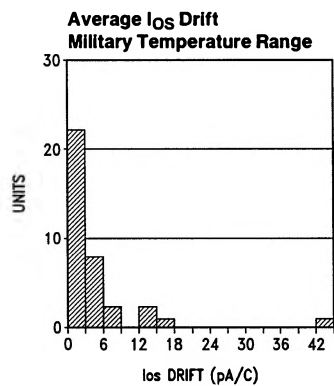

TL/H/9226-23

Typical Performance Distributions (Continued)

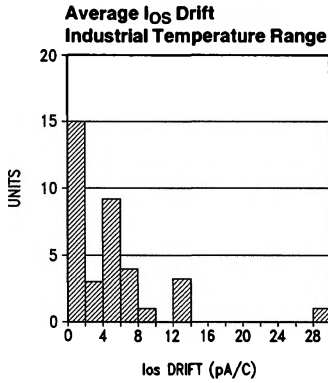

TL/H/9226-24

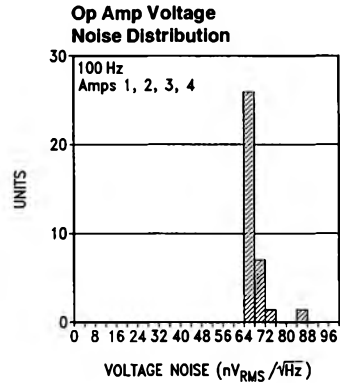

TL/H/9226-27

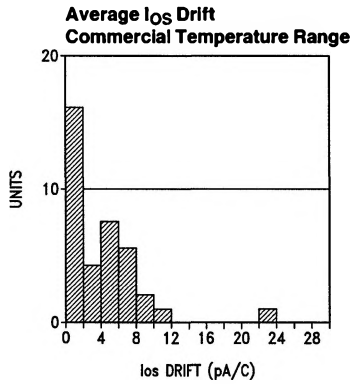

TL/H/9226-25

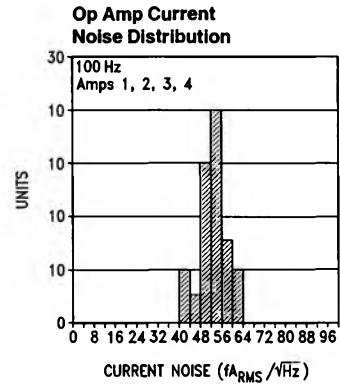

TL/H/9226-28

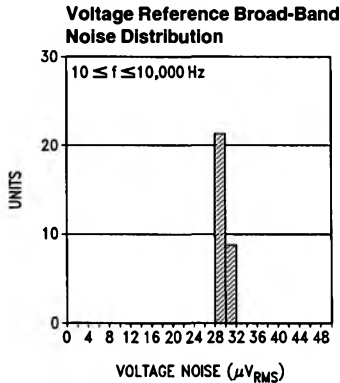

TL/H/9226-26

Application Information

VOLTAGE REFERENCE

Reference Biasing

The voltage reference is of a shunt regulator topology that models as a simple zener diode. With current I_r flowing in the "forward" direction there is the familiar diode transfer function. I_r flowing in the reverse direction forces the reference voltage to be developed from cathode to anode. The cathode may swing from a diode drop below V^- to the reference voltage or to the avalanche voltage of the parallel protection diode, nominally 7V. A 6.3V reference with $V^+ = 3V$ is allowed.

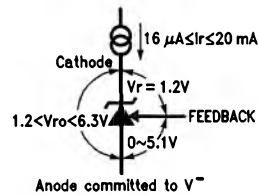

TL/H/9226-29

FIGURE 1. Voltage Associated with Reference (current I_r is external)

Application Information (Continued)

The reference equivalent circuit reveals how V_r is held at the constant 1.2V by feedback, and how the FEEDBACK pin passes little current.

To generate the required reverse current, typically a resistor is connected from a supply voltage higher than the reference voltage. Varying that voltage, and so varying I_r , has small effect with the equivalent series resistance of less than an ohm at the higher currents. Alternatively, an active current source, such as the LM134 series, may generate I_r .

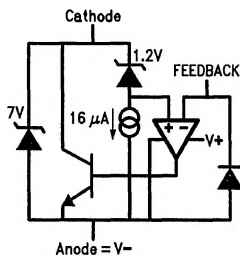

TL/H/9226-30

FIGURE 2. Reference Equivalent Circuit

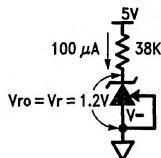

TL/H/9226-31

FIGURE 3. 1.2V Reference

Capacitors in parallel with the reference are allowed. See the Reference AC Stability Range typical curve for capacitance values—from 20 μA to 3 mA any capacitor value is stable. With the reference's wide stability range with resistive and capacitive loads, a wide range of RC filter values will perform noise filtering.

Adjustable Reference

The FEEDBACK pin allows the reference output voltage, V_{ro} , to vary from 1.24V to 6.3V. The reference attempts to hold V_r at 1.24V. If V_r is above 1.24V, the reference will conduct current from Cathode to Anode; FEEDBACK current always remains low. If FEEDBACK is connected to Anode, then $V_{ro} = V_r = 1.24\text{V}$. For higher voltages FEEDBACK is held at a constant voltage above Anode—say 3.76V for $V_{ro} = 5\text{V}$. Connecting a resistor across the constant V_r generates a current $I = R1/V_r$, flowing from Cathode into FEEDBACK node. A Thevenin equivalent 3.76V is generated from FEEDBACK to Anode with $R2 = 3.76/I$. Keep I greater than one thousand times larger than FEEDBACK bias current for $<0.1\%$ error— $\geq 32\ \mu\text{A}$ for the military grade over the military temperature range ($\geq 5.5\ \mu\text{A}$ for a 1% untrimmed error for a commercial part).

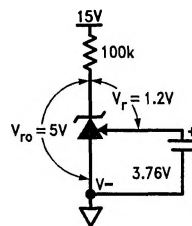

TL/H/9226-32

FIGURE 4. Thevenin Equivalent of Reference with 5V Output

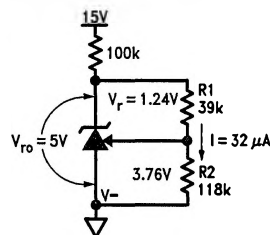

TL/H/9226-33

$$R1 = V_r / I = 1.24 / 32\ \mu = 39\text{k}$$

$$R2 = R1 \{ (V_{ro}/V_r) - 1 \} = 39\text{k} \{ (5/1.24) - 1 \} = 118\text{k}$$

FIGURE 5. Resistors R1 and R2 Program Reference Output Voltage to be 5V

Understanding that V_r is fixed and that voltage sources, resistors, and capacitors may be tied to the FEEDBACK pin, a range of V_r temperature coefficients may be synthesized.

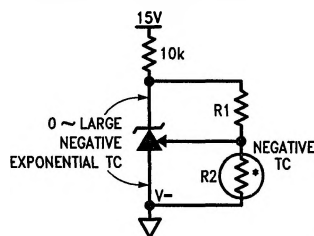

TL/H/9226-34

FIGURE 6. Output Voltage has Negative Temperature Coefficient (TC) if R2 has Negative TC

Application Information (Continued)

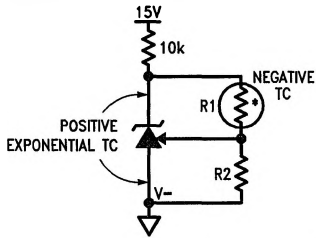

FIGURE 7. Output Voltage has Positive TC if R1 has Negative TC

TL/H/9226-35

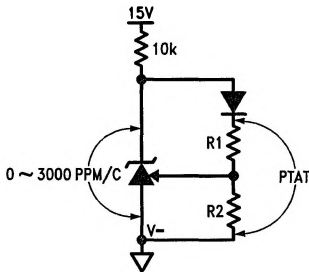
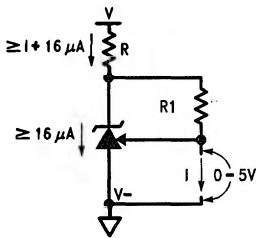

FIGURE 8. Diode in Series with R1 Causes Voltage Across R1 and R2 to be Proportional to Absolute Temperature (PTAT)

TL/H/9226-36

Connecting a resistor across Cathode-to-FEEDBACK creates a 0 TC current source, but a range of TCs may be synthesized.



$$I = V_r/R1 = 1.24/R1$$

FIGURE 9. Current Source is Programmed by R1

TL/H/9226-37

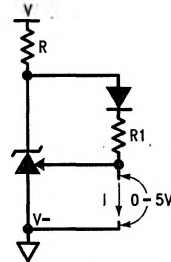

FIGURE 10. Proportional-to-Absolute-Temperature Current Source

TL/H/9226-38

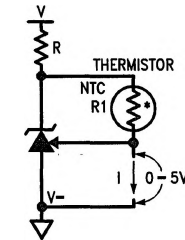

FIGURE 11. Negative-TC Current Source

TL/H/9226-39

Reference Hysteresis

The reference voltage depends, slightly, on the thermal history of the die. Competitive micro-power products vary—always check the data sheet for any given device. Do not assume that no specification means no hysteresis.

OPERATIONAL AMPLIFIERS AND COMPARATORS

Any amp, comparator, or the reference may be biased in any way with no effect on the other sections of the LM613, except when a substrate diode conducts (see Electrical Characteristics Note 1). For example, one amp input may be outside the common-mode range, another amp may be operating as a comparator, and all other sections may have all terminals floating with no effect on the others. Tying inverting input to output and non-inverting input to V^- on unused amps is preferred. Unused comparators should have non-inverting input and output tied to V^+ , and inverting input tied to V^- . Choosing operating point that cause oscillation, such as driving too large a capacitive load, is best avoided.

Op Amp Output Stage

These op amps, like the LM124 series, have flexible and relatively wide-swing output stages. There are simple rules to optimize output swing, reduce cross-over distortion, and optimize capacitive drive capability:

- 1) Output Swing: Unloaded, the $42 \mu\text{A}$ pull-down will bring the output within 300 mV of V^- over the military temperature range. If more than $42 \mu\text{A}$ is required, a resistor from output to V^- will help. Swing across any load may be improved slightly if the load can be tied to V^+ , at the cost of poorer sinking open-loop voltage gain.

Application Information (Continued)

- 2) Cross-Over Distortion: The LM613 has lower cross-over distortion (a $1 V_{BE}$ deadband versus $3 V_{BE}$ for the LM124), and increased slew rate as shown in the characteristic curves. A resistor pull-up or pull-down will force class-A operation with only the PNP or NPN output transistor conducting, eliminating cross-over distortion.
- 3) Capacitive Drive: Limited by the output pole caused by the output resistance driving capacitive loads, a pull-down resistor conducting 1 mA or more reduces the output stage NPN r_o until the output resistance is that of the current limit 25Ω . 200 pF may then be driven without oscillation.

Comparator Output Stage

The comparators, like the LM139 series, have open-collector output stages. A pull-up resistor must be added from each output pin to a positive voltage for the output transistor to switch properly. When the output transistor is OFF, the output voltage will be this external positive voltage.

For the output voltage to be under the TTL-low voltage threshold when the output transistor is ON, the output current must be less than 8 mA (over temperature). This impacts the minimum value of pull-up resistor.

The offset voltage may increase when the output voltage is low and the output current is less than $30 \mu\text{A}$. Thus, for best accuracy, the pull-up resistor value should be low enough to allow the output transistor to sink more than $30 \mu\text{A}$.

Op Amp and Comparator Input Stage

The lateral PNP input transistors, unlike those of most op amps, have BV_{EBO} equal to the absolute maximum supply voltage. Also, they have no diode clamps to the positive supply nor across the inputs. These features make the inputs look like high impedances to input sources producing large differential and common-mode voltages.

Typical Applications

For typical applications, refer to the LM124 Op Amp, LM139 Comparator, and LM185 Adjustable Reference datasheets.