

# LM4917 Boomer™ Audio Power Amplifier Series Ground-Referenced, 95mW Stereo Headphone Amplifier

Check for Samples: [LM4917](#)

## FEATURES

- Ground Referenced Outputs
- High PSRR
- Available in Space-Saving TSSOP Package
- Ultra Low Current Shutdown Mode
- Improved Pop and Click Circuitry eliminates Noises During Turn-On and Turn-Off Transitions
- 1.4 – 3.6V Operation
- No Output Coupling Capacitors, Snubber Networks, Bootstrap Capacitors
- Shutdown Either Channel Independently

## APPLICATIONS

- Notebook PCs
- Desktop PCs
- Mobile Phone
- PDAs
- Portable Electronic Devices

## KEY SPECIFICATIONS

- Improved PSRR at 1kHz, 70dB (Typ)
- Power Output at  $V_{DD} = 3V$ ,  $R_L = 16\Omega$ ,  $THD \leq 1\%$ , 95mW (Typ)
- Shutdown Current, 0.01 $\mu$ A (Typ)

## DESCRIPTION

The LM4917 is a stereo, output capacitor-less headphone amplifier capable of delivering 95mW of continuous average power into a 16 $\Omega$  load with less than 1% THD+N from a single 3V power supply.

The LM4917 provides high quality audio reproduction with minimal external components. A ground referenced output eliminates the output coupling capacitors typically required by single-ended loads, reducing component count, cost and board space consumption. This makes the LM4917 ideal for mobile phones and other portable equipment where board space is at a premium. Eliminating the output coupling capacitors also improves low frequency response.

The LM4917 operates from a single 1.4V to 3.6V power supply, features low 0.02% THD+N and 70dB PSRR. Independent right/left channel low-power shutdown controls provide power saving flexibility for mono/stereo applications. Superior click and pop suppression eliminates audible transients during start up and shutdown. Short circuit and thermal overload protection protects the device during fault conditions.

**Block Diagram**

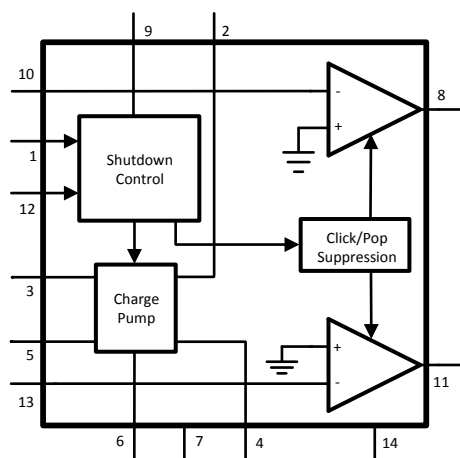

**Figure 1. Circuit Block Diagram**



Please be aware that an important notice concerning availability, standard warranty, and use in critical applications of Texas Instruments semiconductor products and disclaimers thereto appears at the end of this data sheet.

Boomer is a trademark of Texas Instruments.

All other trademarks are the property of their respective owners.

Typical Application

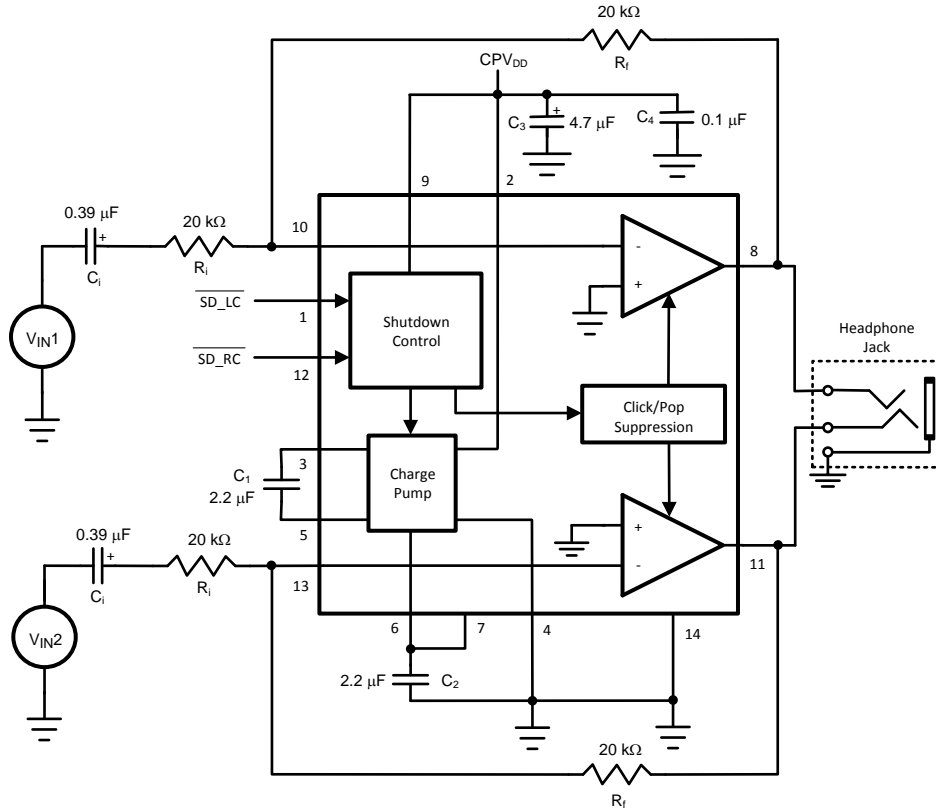
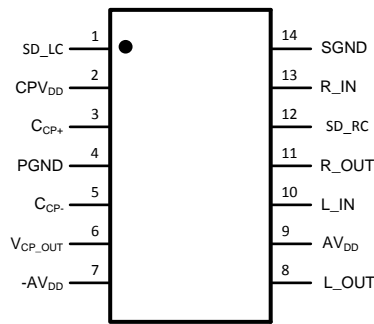
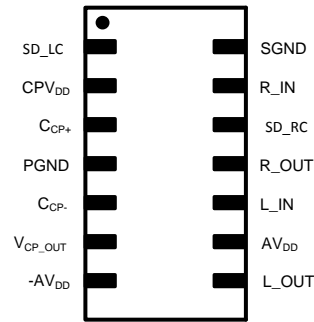

Figure 2. Typical Audio Amplifier Application Circuit



TSSOP Package  
 Top View  
 See Package Number PW



**WSON Package  
Top View  
See Package Number NHK0014A**

### PIN DESCRIPTIONS

Pin	Name	Function
1	SD_LC	Active_Low Shutdown, Left Channel
2	CPVDD	Charge Pump Power Supply
3	C_CP+	Positive Terminal-Charge Pump Flying Capacitor
4	PGND	Power Ground
5	C_CP-	Negative Terminal- Charge Pump Flying Capacitor
6	V_CP_OUT	Charge Pump Output
7	-AVDD	Negative Power Supply-Amplifier
8	L_OUT	Left Channel Output
9	AVDD	Positive Power Supply-Amplifier
10	L_IN	Left Channel Input
11	R_OUT	Right Channel Output
12	SD_RC	Active_Low Shutdown, Right Channel
13	R_IN	Right Channel Input
14	SGND	Signal Ground



This integrated circuit can be damaged by ESD. Texas Instruments recommends that all integrated circuits be handled with appropriate precautions. Failure to observe proper handling and installation procedures can cause damage.

ESD damage can range from subtle performance degradation to complete device failure. Precision integrated circuits may be more susceptible to damage because very small parametric changes could cause the device not to meet its published specifications.

### Absolute Maximum Ratings<sup>(1)</sup>

Supply Voltage		4.0V
Storage Temperature		-65°C to +150°C
Input Voltage		-0.3V to $V_{DD} + 0.3V$
Power Dissipation <sup>(2)</sup>		Internally Limited
ESD Susceptibility <sup>(3)</sup>		2000V
ESD Susceptibility <sup>(4)</sup>		200V
Junction Temperature		150°C
Thermal Resistance	$\theta_{JC}$ (TSSOP)	40°C/W
	$\theta_{JA}$ (TSSOP)	109°C/W

- (1) Absolute Maximum Ratings indicate limits beyond which damage to the device may occur. Operating Ratings indicate conditions for which the device is functional but do not specify performance limits. Electrical Characteristics state DC and AC electrical specifications under particular test conditions that guarantee specific performance limits. This assumes that the device is within the Operating Ratings. Specifications are not guaranteed for parameters where no limit is given; however, the typical value is a good indication of device performance.
- (2) The maximum power dissipation must be derated at elevated temperatures and is dictated by  $T_{JMAX}$ ,  $\theta_{JA}$ , and the ambient temperature,  $T_A$ . The maximum allowable power dissipation is  $P_{DMAX} = (T_{JMAX} - T_A) / \theta_{JA}$  or the number given in Absolute Maximum Ratings, whichever is lower. For the LM4917, see power de-rating currents for more information.
- (3) Human body model, 100pF discharged through a 1.5k $\Omega$  resistor.
- (4) Machine Model, 220pF-240pF discharged through all pins.

### Operating Ratings

Temperature Range	$T_{MIN} \leq T_A \leq T_{MAX}$	$-40^\circ\text{C} \leq T_A \leq 85^\circ\text{C}$
	Supply Voltage ( $V_{DD}$ ) <sup>(1)</sup>	$1.4V \leq V_{CC} \leq 3.6V$

- (1) If the product is in shutdown mode and  $V_{DD}$  exceeds 3.6V (to a max of 4V  $V_{DD}$ ) then most of the excess current will flow through the ESD protection circuits. If the source impedance limits the current to a max of 10mA, then the part will be protected. If the part is enabled when  $V_{DD}$  is above 4V circuit performance will be curtailed or the part may be permanently damaged.

**Electrical Characteristics  $V_{DD} = 3V^{(1)}$** 

The following specifications apply for  $V_{DD} = 3V$ ,  $A_V = 1$ , and  $16\Omega$  load unless otherwise specified. Limits apply to  $T_A = 25^\circ C$ .

Symbol	Parameter	Conditions	LM4917		Units (Limits)
			Typ <sup>(2)</sup>	Limit <sup>(3)(4)</sup>	
$I_{DD}$	Quiescent Power Supply Current	$V_{IN} = 0V$ , $I_O = 0A$ , both channels enabled	11	20	mA (max)
		$V_{IN} = 0V$ , $I_O = 0A$ , one channel enabled	9		mA
$I_{SD}$	Shutdown Current	$V_{SD\_LC} = V_{SD\_RC} = GND$	0.01	1	$\mu A$ (max)
$V_{OS}$	Output Offset Voltage	$R_L = 32\Omega$	1	10	mV (max)
$P_O$	Output Power	THD+N = 1% (max); $f = 1kHz$ , $R_L = 16\Omega$	95	50	mW (min)
		THD+N = 1% (max); $f = 1kHz$ , $R_L = 32\Omega$	82		mW
THD+N	Total Harmonic Distortion + Noise	$P_O = 50mW$ , $f = 1kHz$ , $R_L = 32\Omega$ (A-weighted) single channel	0.02		%
PSRR	Power Supply Rejection Ratio	$V_{RIPPLE} = 200mV$ sine p-p, $f = 1kHz$ $f = 20kHz$	70		dB
			55		
SNR	Signal-to-Noise Ratio	$R_L = 32\Omega$ , $P_{OUT} = 20mW$ , $f = 1kHz$	100		dB
$V_{IH}$	Shutdown Input Voltage High		$V_{IH} = 0.7 \cdot CPV_{DD}$		V (min)
$V_{IL}$	Shutdown Input Voltage Low		$V_{IL} = 0.3 \cdot CPV_{DD}$		V (max)
$T_{WU}$	Wake Up Time From Shutdown		339		$\mu s$ (max)
$X_{TALK}$	Crosstalk	$R_L = 16\Omega$ , $P_O = 1.6mW$ , $f = 1kHz$	70		dB
$I_L$	Input Leakage Current		$\pm 0.1$		nA

- (1) All voltages are measured with respect to the GND pin unless otherwise specified.
- (2) Typicals are measured at  $25^\circ C$  and represent the parametric norm.
- (3) Limits are specified to Texas Instruments' AOQL (Average Outgoing Quality Level).
- (4) Datasheet min/max specification limits are specified by design, test, or statistical analysis.

## External Components Description

(See [Figure 1](#))

Components		Functional Description
1.	$R_i$	Inverting input resistance which sets the closed-loop gain in conjunction with $R_f$ . This resistor also forms a high-pass filter with $C_i$ at $f_c = 1 / (2\pi R_i C_i)$ .
2.	$C_i$	Input coupling capacitor which blocks the DC voltage at the amplifier's input terminals. Also creates a high-pass filter with $R_i$ at $f_c = 1 / (2\pi R_i C_i)$ . Refer to the section <b>Proper Selection of External Components</b> , for an explanation of how to determine the value of $C_i$ .
3.	$R_f$	Feedback resistance which sets the closed-loop gain in conjunction with $R_i$ .
4.	$C_1$	Flying capacitor. Low ESR ceramic capacitor ( $\leq 100m\Omega$ )
5.	$C_2$	Output capacitor. Low ESR ceramic capacitor ( $\leq 100m\Omega$ )
6.	$C_3$	Tantalum capacitor. Supply bypass capacitor which provides power supply filtering. Refer to the <a href="#">POWER SUPPLY BYPASSING</a> section for information concerning proper placement and selection of the supply bypass capacitor.
7.	$C_4$	Ceramic capacitor. Supply bypass capacitor which provides power supply filtering. Refer to the <a href="#">POWER SUPPLY BYPASSING</a> section for information concerning proper placement and selection of the supply bypass capacitor.

### Typical Performance Characteristics

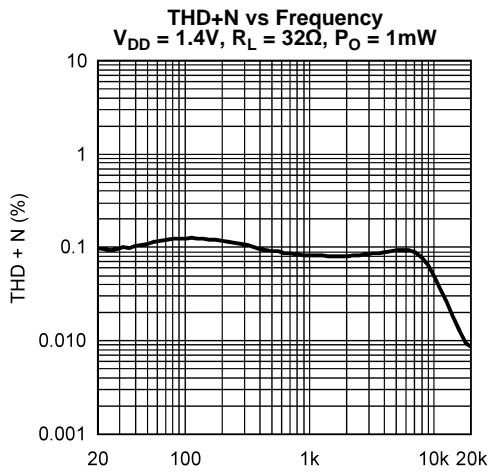

FREQUENCY (Hz)  
**Figure 3.**

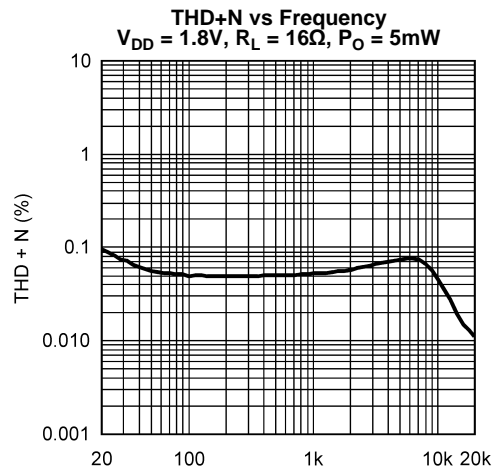

FREQUENCY (Hz)  
**Figure 4.**

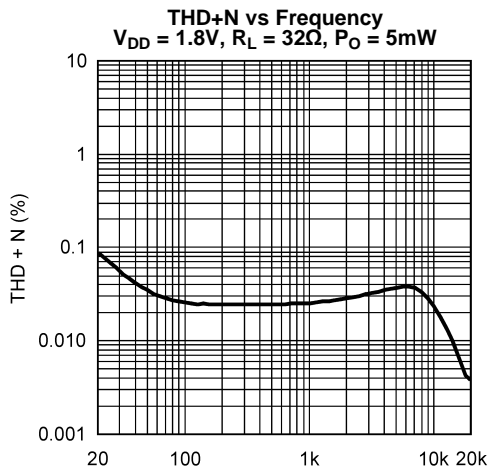

FREQUENCY (Hz)  
**Figure 5.**

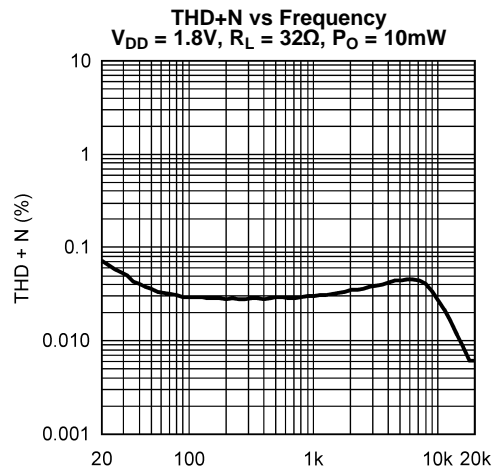

FREQUENCY (Hz)  
**Figure 6.**

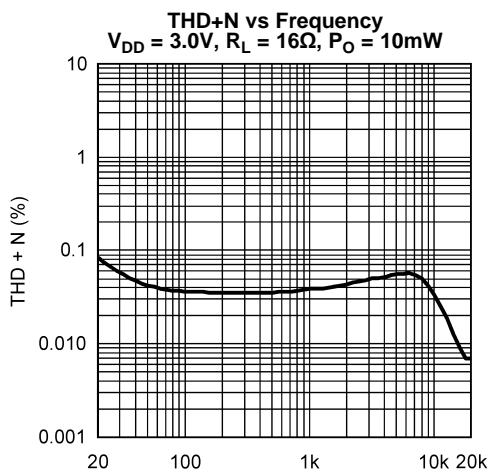

FREQUENCY (Hz)  
**Figure 7.**

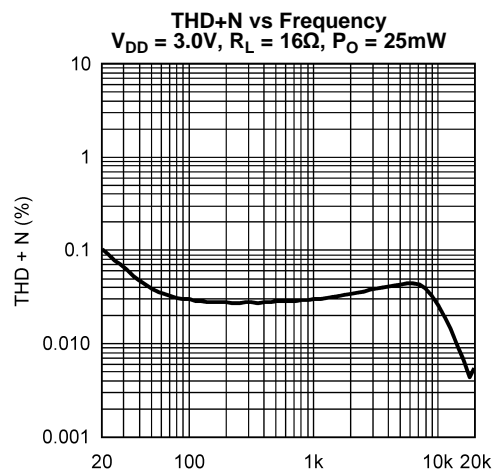

FREQUENCY (Hz)  
**Figure 8.**

Typical Performance Characteristics (continued)

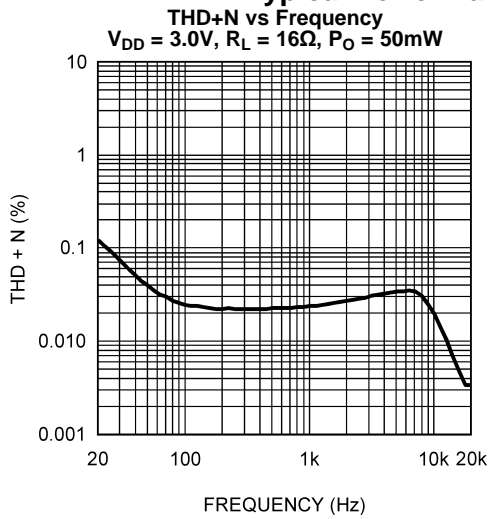

Figure 9.

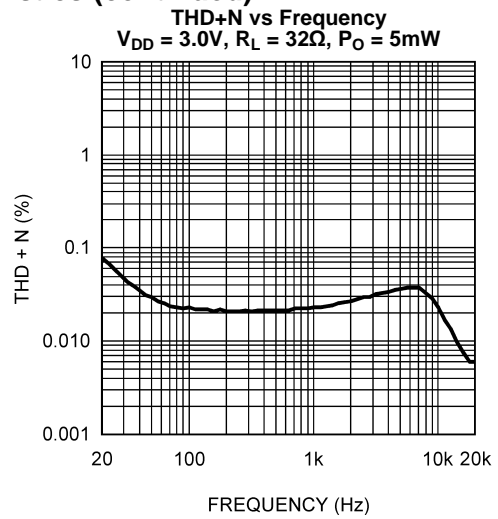

Figure 10.

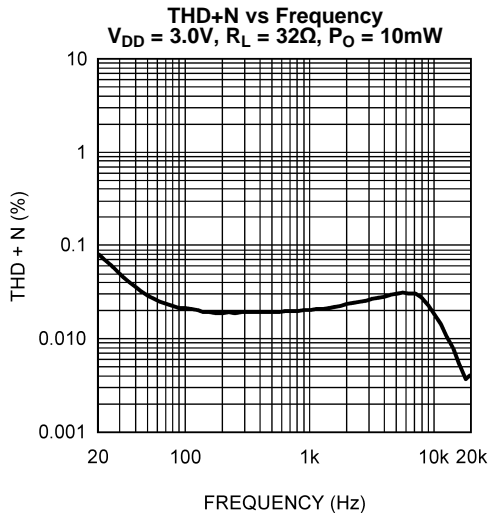

Figure 11.

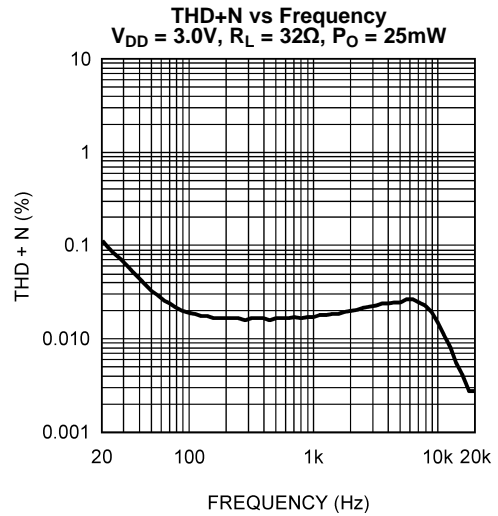

Figure 12.

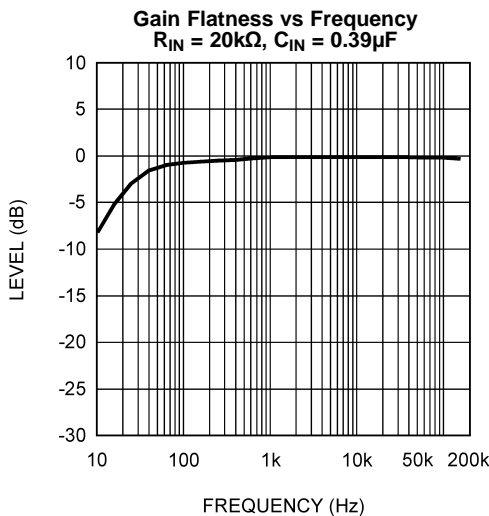

Figure 13.

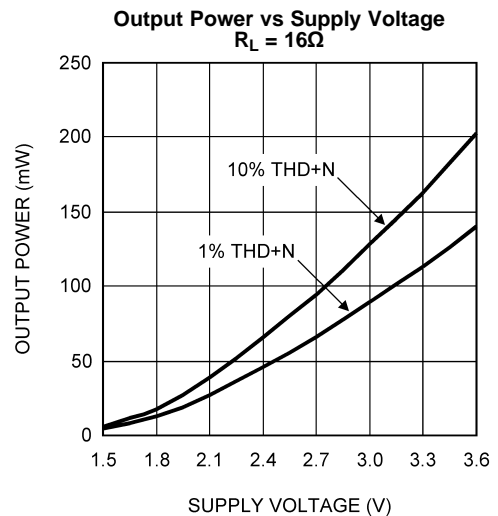

Figure 14.

**Typical Performance Characteristics (continued)**

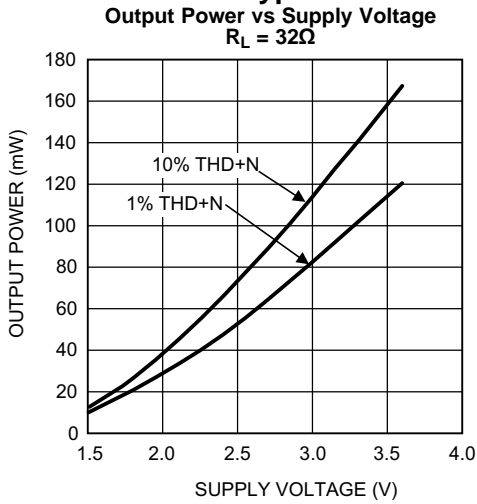

Figure 15.

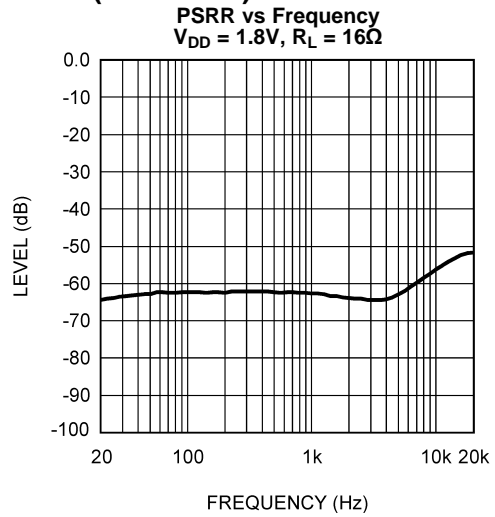

Figure 16.

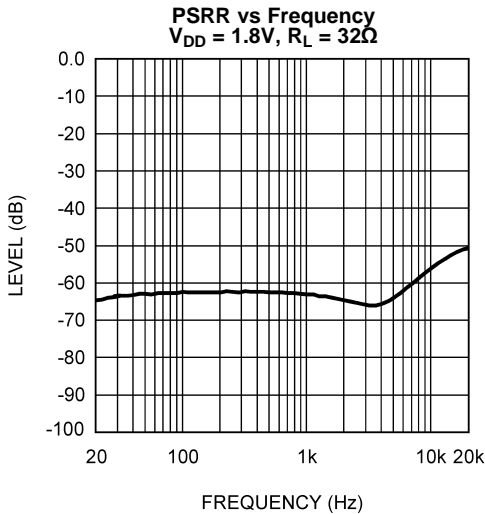

Figure 17.

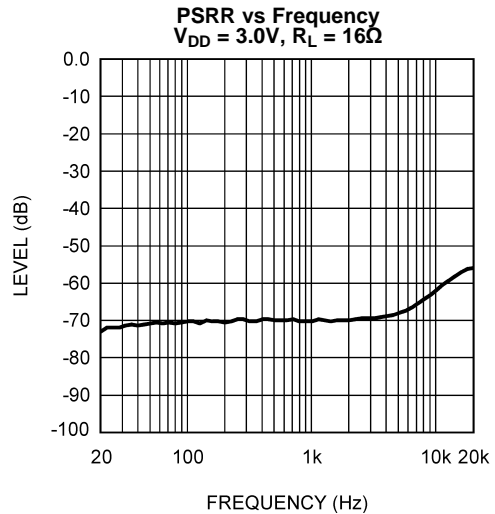

Figure 18.

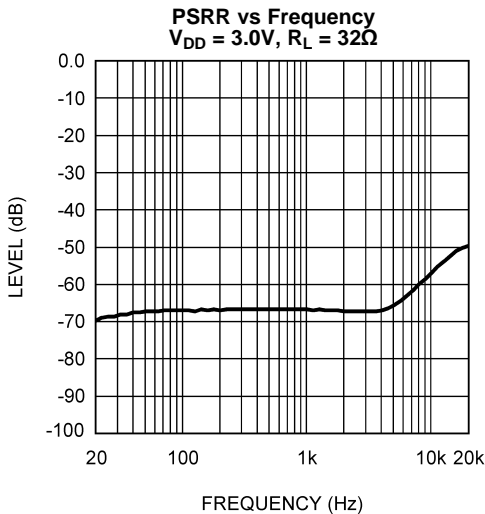

Figure 19.

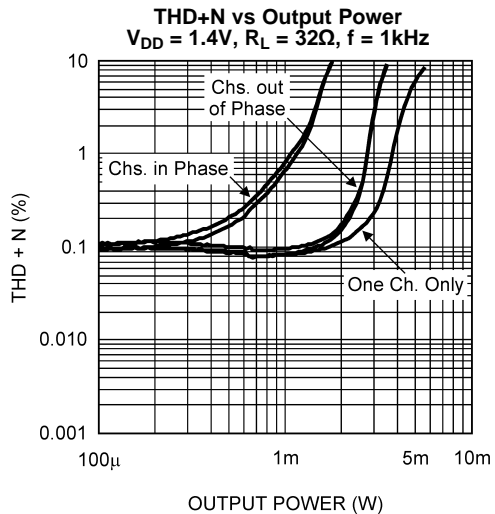

Figure 20.

Typical Performance Characteristics (continued)

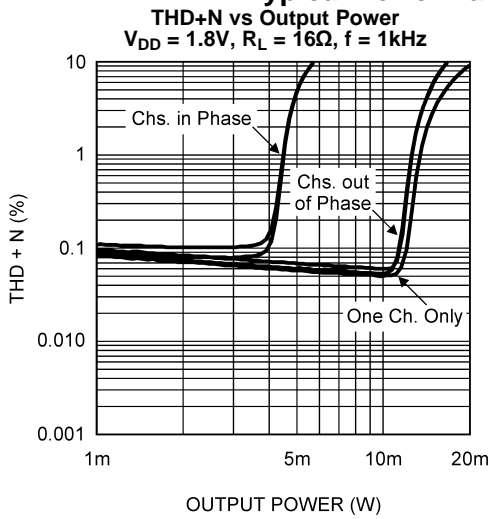

Figure 21.

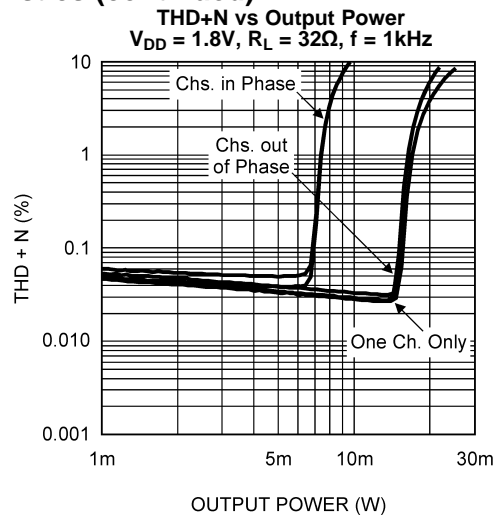

Figure 22.

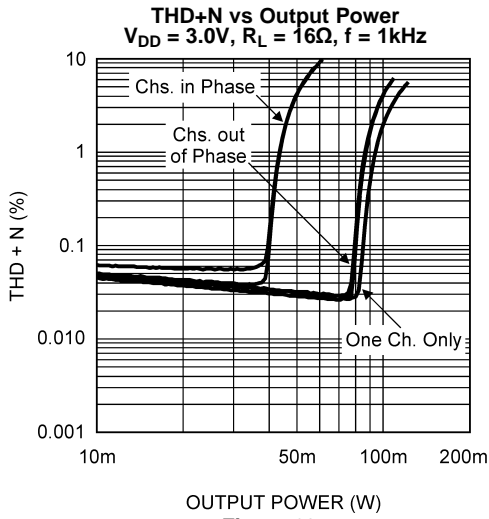

Figure 23.

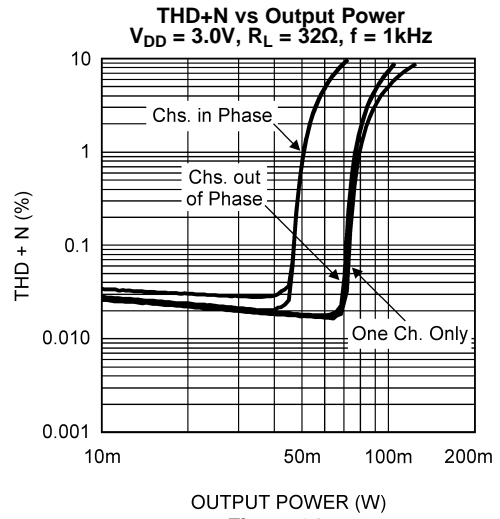

Figure 24.

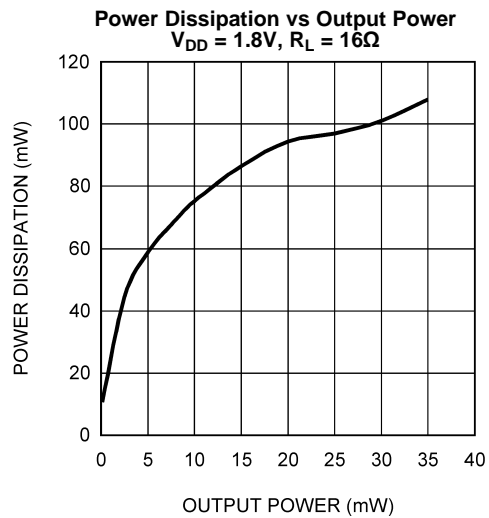

Figure 25.

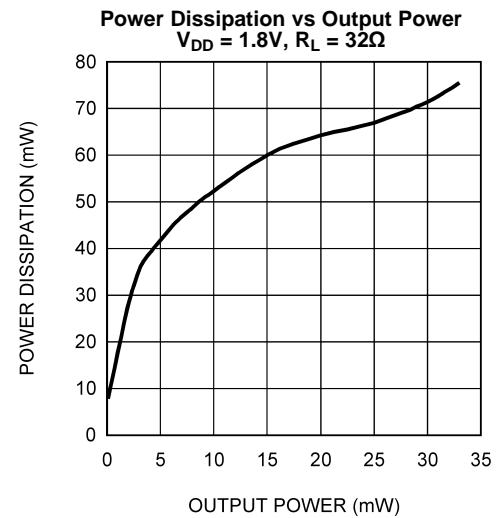

Figure 26.

**Typical Performance Characteristics (continued)**

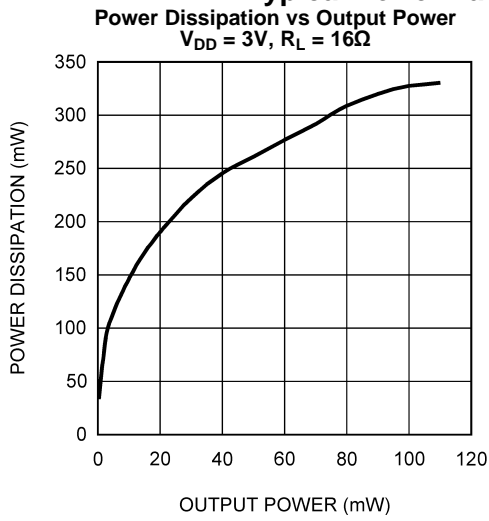

Figure 27.

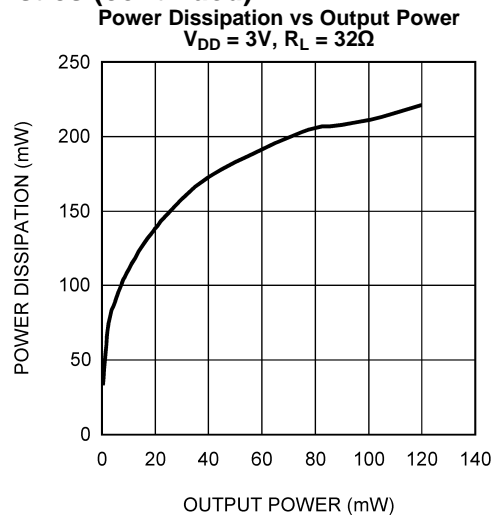

Figure 28.

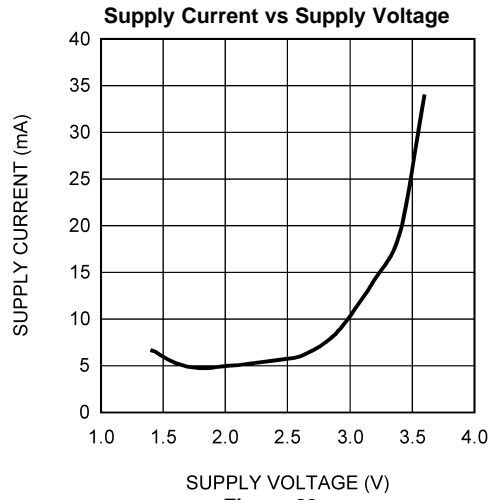

Figure 29.

## APPLICATION INFORMATION

### ELIMINATING THE OUTPUT COUPLING CAPACITOR

The LM4917 features a low noise inverting charge pump that generates an internal negative supply voltage. This allows the outputs of the LM4917 to be biased about GND instead of a nominal DC voltage, like traditional headphone amplifiers. Because there is no DC component, the large DC blocking capacitors (typically 220µF) are not necessary. The coupling capacitors are replaced by two, small ceramic charge pump capacitors, saving board space and cost.

Eliminating the output coupling capacitors also improves low frequency response. The headphone impedance and the output capacitor form a high pass filter that not only blocks the DC component of the output, but also attenuates low frequencies, impacting the bass response. Because the LM4917 does not require the output coupling capacitors, the low frequency response of the device is not degraded by external components.

In addition to eliminating the output coupling capacitors, the ground referenced output nearly doubles the available dynamic range of the LM4917 when compared to a traditional headphone amplifier operating from the same supply voltage.

### OUTPUT TRANSIENT ('CLICK AND POPS') ELIMINATED

The LM4917 contains advanced circuitry that virtually eliminates output transients ('clicks and pops'). This circuitry prevents all traces of transients when the supply voltage is first applied or when the part resumes operation after coming out of shutdown mode.

To ensure optimal click and pop performance under low gain configurations (less than 0dB), it is critical to minimize the RC combination of the feedback resistor  $R_F$  and stray input capacitance at the amplifier inputs. A more reliable way to lower gain or reduce power delivered to the load is to place a current limiting resistor in series with the load as explained in the **Minimizing Output Noise / Reducing Output Power** section.

### AMPLIFIER CONFIGURATION EXPLANATION

As shown in [Figure 2](#), the LM4917 has two operational amplifiers internally. The two amplifiers have externally configurable gain, and the closed loop gain is set by selecting the ratio of  $R_f$  to  $R_i$ . Consequently, the gain for each channel of the IC is

$$A_V = -(R_f / R_i) \quad (1)$$

Since this an output ground-referenced amplifier, by driving the headphone through  $R_{OUT}$  (Pin 11) and  $L_{OUT}$  (Pin 8), the LM4917 does not require output coupling capacitors. The typical single-ended amplifier configuration where one side of the load is connected to ground requires large, expensive output capacitors.

### POWER DISSIPATION

Power dissipation is a major concern when using any power amplifier and must be thoroughly understood to ensure a successful design. [Equation 1](#) states the maximum power dissipation point for a single-ended amplifier operating at a given supply voltage and driving a specified output load.

$$P_{DMAX} = (V_{DD})^2 / (2\pi^2 R_L) \quad (2)$$

Since the LM4917 has two operational amplifiers in one package, the maximum internal power dissipation point is twice that of the number which results from [Equation 1](#). Even with the large internal power dissipation, the LM4917 does not require heat sinking over a large range of ambient temperature. From [Equation 1](#), assuming a 3V power supply and a 16Ω load, the maximum power dissipation point is 28mW per amplifier. Thus the maximum package dissipation point is 56mW. The maximum power dissipation point obtained must not be greater than the power dissipation that results from [Equation 2](#):

$$P_{DMAX} = (T_{JMAX} - T_A) / (\theta_{JA}) \quad (3)$$

For package TSSOP,  $\theta_{JA} = 109^{\circ}\text{C/W}$ .  $T_{JMAX} = 150^{\circ}\text{C}$  for the LM4917. Depending on the ambient temperature,  $T_A$ , of the system surroundings, Equation 2 can be used to find the maximum internal power dissipation supported by the IC packaging. If the result of Equation 1 is greater than that of Equation 2, then either the supply voltage must be decreased, the load impedance increased or  $T_A$  reduced. For the typical application of a 3V power supply, with a  $16\Omega$  load, the maximum ambient temperature possible without violating the maximum junction temperature is approximately  $119.9^{\circ}\text{C}$  provided that device operation is around the maximum power dissipation point. Power dissipation is a function of output power and thus, if typical operation is not around the maximum power dissipation point, the ambient temperature may be increased accordingly. Refer to the [Typical Performance Characteristics](#) curves for power dissipation information for lower output powers.

## POWER SUPPLY BYPASSING

As with any power amplifier, proper supply bypassing is critical for low noise performance and high power supply rejection. Applications that employ a 3V power supply typically use a  $4.7\mu\text{F}$  in parallel with a  $0.1\mu\text{F}$  ceramic filter capacitors to stabilize the power supply's output, reduce noise on the supply line, and improve the supply's transient response. However, their presence does not eliminate the need for a local  $0.1\mu\text{F}$  supply bypass capacitor,  $C_S$ , connected between the LM4917's supply pins and ground. Keep the length of leads and traces that connect capacitors between the LM4917's power supply pin and ground as short as possible.

## MICRO POWER SHUTDOWN

The voltage applied to the  $\overline{\text{SD\_LC}}$  (shutdown left channel) pin and the  $\overline{\text{SD\_RC}}$  (shutdown right channel) pin controls the LM4917's shutdown function. When active, the LM4917's micropower shutdown feature turns off the amplifiers' bias circuitry, reducing the supply current. The trigger point is  $0.3 \times \text{CPV}_{DD}$  for a logic-low level, and  $0.7 \times \text{CPV}_{DD}$  for logic-high level. The low  $0.01\mu\text{A}(\text{typ})$  shutdown current is achieved by applying a voltage that is as near as ground as possible to the  $\overline{\text{SD\_LC}}/\overline{\text{SD\_RC}}$  pins. A voltage that is higher than ground may increase the shutdown current.

There are a few ways to control the micro-power shutdown. These include using a single-pole, single-throw switch, a microprocessor, or a microcontroller. When using a switch, connect an external  $100\text{k}\Omega$  pull-up resistor between the  $\overline{\text{SD\_LC}}/\overline{\text{SD\_RC}}$  pins and  $V_{DD}$ . Connect the switch between the  $\overline{\text{SD\_LC}}/\overline{\text{SD\_RC}}$  pins and ground. Select normal amplifier operation by opening the switch. Closing the switch connects the  $\overline{\text{SD\_LC}}/\overline{\text{SD\_RC}}$  pins to ground, activating micro-power shutdown. The switch and resistor guarantee that the  $\overline{\text{SD\_LC}}/\overline{\text{SD\_RC}}$  pins will not float. This prevents unwanted state changes. In a system with a microprocessor or microcontroller, use a digital output to apply the control voltage to the  $\overline{\text{SD\_LC}}/\overline{\text{SD\_RC}}$  pins. Driving the  $\overline{\text{SD\_LC}}/\overline{\text{SD\_RC}}$  pins with active circuitry eliminates the pull-up resistor.

## SELECTING PROPER EXTERNAL COMPONENTS

Optimizing the LM4917's performance requires properly selecting external components. Though the LM4917 operates well when using external components with wide tolerances, best performance is achieved by optimizing component values.

The LM4917 is unity-gain stable, giving a designer maximum design flexibility. The gain should be set to no more than a given application requires. This allows the amplifier to achieve minimum THD+N and maximum signal-to-noise ratio. These parameters are compromised as the closed-loop gain increases. However, low gain demands input signals with greater voltage swings to achieve maximum output power. Fortunately, many signal sources such as audio CODECs have outputs of  $1V_{RMS}$  ( $2.83V_{P-P}$ ). Please refer to the [AUDIO POWER AMPLIFIER DESIGN](#) section for more information on selecting the proper gain.

### Charge Pump Capacitor Selection

Choose low ESR ( $<100\text{m}\Omega$ ) ceramic capacitors for optimum performance. Low ESR capacitors keep the charge pump output impedance to a minimum, extending the headroom on the negative supply. Choose capacitors with an X7R dielectric for best performance over temperature.

Charge pump load regulation and output resistance is affected by the value of the flying capacitor ( $C_1$ ). A larger valued  $C_1$  improves load regulation and minimizes charge pump output resistance. The switch on-resistance and capacitor ESR dominates the output resistance for capacitor values above  $2.2\mu\text{F}$ .

The output ripple is affected by the value and ESR of the output capacitor ( $C_2$ ). Larger valued capacitors reduce output ripple on the negative power supply. Lower ESR capacitors minimizes the output ripple and reduces the output resistance of the charge pump.

## Input Capacitor Value Selection

Amplifying the lowest audio frequencies requires high value input coupling capacitor ( $C_i$  in [Figure 2](#)). A high value capacitor can be expensive and may compromise space efficiency in portable designs. In many cases, however, the speakers used in portable systems, whether internal or external, have little ability to reproduce signals below 150Hz. Applications using speakers with this limited frequency response reap little improvement by using high value input and output capacitors.

Besides affecting system cost and size,  $C_i$  has an effect on the LM4917's click and pop performance. The magnitude of the pop is directly proportional to the input capacitor's size. Thus, pops can be minimized by selecting an input capacitor value that is no higher than necessary to meet the desired  $-3\text{dB}$  frequency.

As shown in [Figure 2](#), the input resistor,  $R_i$  and the input capacitor,  $C_i$ , produce a  $-3\text{dB}$  high pass filter cutoff frequency that is found using Equation (3).

$$f_{i-3\text{dB}} = 1 / 2\pi R_i C_i \quad (4)$$

Also, careful consideration must be taken in selecting a certain type of capacitor to be used in the system. Different types of capacitors (tantalum, electrolytic, ceramic) have unique performance characteristics and may affect overall system performance.

## AUDIO POWER AMPLIFIER DESIGN

### Design a Dual 90mW/16Ω Audio Amplifier

Given:	
Power Output	90mW
Load Impedance	16Ω
Input Level	1Vrms (max)
Input Impedance	20kΩ
Bandwidth	100Hz–20kHz $\pm$ 0.50dB

The design begins by specifying the minimum supply voltage necessary to obtain the specified output power. One way to find the minimum supply voltage is to use the Output Power vs Supply Voltage curve in the [Typical Performance Characteristics](#) section. Another way, using [Equation 5](#), is to calculate the peak output voltage necessary to achieve the desired output power for a given load impedance. For a single-ended application, the result is [Equation 5](#).

$$V_{\text{opeak}} = \sqrt{(2R_L P_O)} \quad (5)$$

$$V_{\text{DD}} \geq [2V_{\text{OPEAK}} + (V_{\text{DOTOP}} + V_{\text{DOBOT}})] \quad (6)$$

The Output Power vs Supply Voltage graph for a 16Ω load indicates a minimum supply voltage of 3.1V. This is easily met by the commonly used 3.3V supply voltage. The additional voltage creates the benefit of headroom, allowing the LM4917 to produce peak output power in excess of 90mW without clipping or other audible distortion. The choice of supply voltage must also not create a situation that violates maximum power dissipation as explained above in the [POWER DISSIPATION](#) section. Remember that the maximum power dissipation point from [Equation 1](#) must be multiplied by two since there are two independent amplifiers inside the package. Once the power dissipation equations have been addressed, the required gain can be determined from [Equation 6](#).

$$A_V \geq \sqrt{(P_O R_L)} / (V_{\text{IN}}) = V_{\text{orms}} / V_{\text{inrms}} \quad (7)$$

Thus, a minimum gain of 1.2 allows the LM4917 to reach full output swing and maintain low noise and THD+N performance. For this example, let  $A_V = 1.5$ .

The amplifiers overall gain is set using the input ( $R_i$ ) and feedback ( $R_f$ ) resistors. With the desired input impedance set at 20kΩ, the feedback resistor is found using Equation (7).

$$A_V = R_f / R_i$$

where

- The value of  $R_i$  is 30kΩ (8)

The last step in this design is setting the amplifier's -3dB frequency bandwidth. To achieve the desired  $\pm 0.25$ dB pass band magnitude variation limit, the low frequency response must extend to at least one-fifth the lower bandwidth limit and the high frequency response must extend to at least five times the upper bandwidth limit. The gain variation for both response limits is 0.17dB, well within the  $\pm 0.25$ dB desired limit. The results are

$$f_L = 100\text{Hz} / 5 = 20\text{Hz} \quad (9)$$

and

$$f_H = 20\text{kHz} \times 5 = 100\text{kHz} \quad (10)$$

As stated in the [External Components Description](#) section, both  $R_i$  in conjunction with  $C_i$ , and  $R_L$ , create first order highpass filters. Thus to obtain the desired low frequency response of 100Hz within  $\pm 0.5$ dB, both poles must be taken into consideration. The combination of two single order filters at the same frequency forms a second order response. This results in a signal which is down 0.34dB at five times away from the single order filter -3dB point. Thus, a frequency of 20Hz is used in the following equations to ensure that the response is better than 0.5dB down at 100Hz.

$$C_i \geq 1 / (2\pi * 20\text{k}\Omega * 20\text{Hz}) = 0.397\mu\text{F}; \text{ use } 0.39\mu\text{F} \quad (11)$$

The high frequency pole is determined by the product of the desired high frequency pole,  $f_H$ , and the closed-loop gain,  $A_V$ . With a closed-loop gain of 1.5 and  $f_H = 100\text{kHz}$ , the resulting GBWP = 150kHz which is much smaller than the LM4917's GBWP of 3MHz. This figure displays that if a designer has a need to design an amplifier with a higher gain, the LM4917 can still be used without running into bandwidth limitations.

LM4917 TSSOP Demo Board Artwork

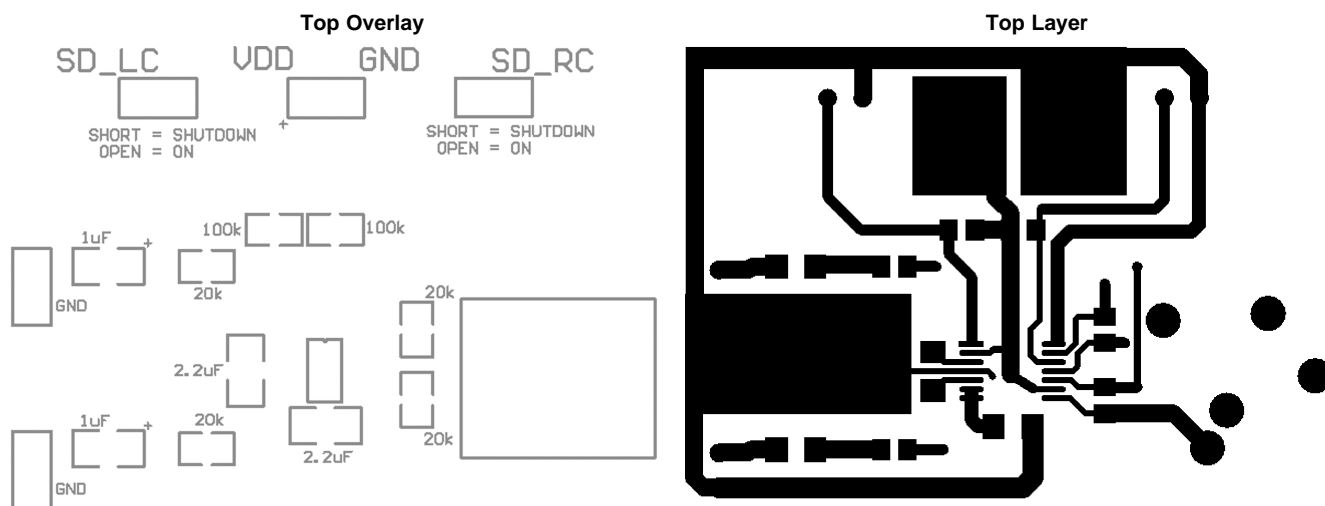

NATIONAL SEMICONDUCTOR  
LM4917MT Audio Power Amplifier



Bottom Layer

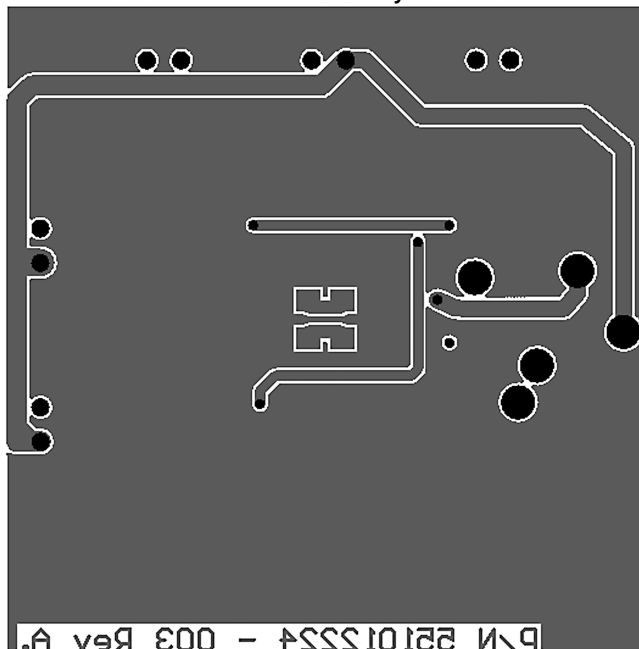

**LM4917 WSON Demo Board Artwork**

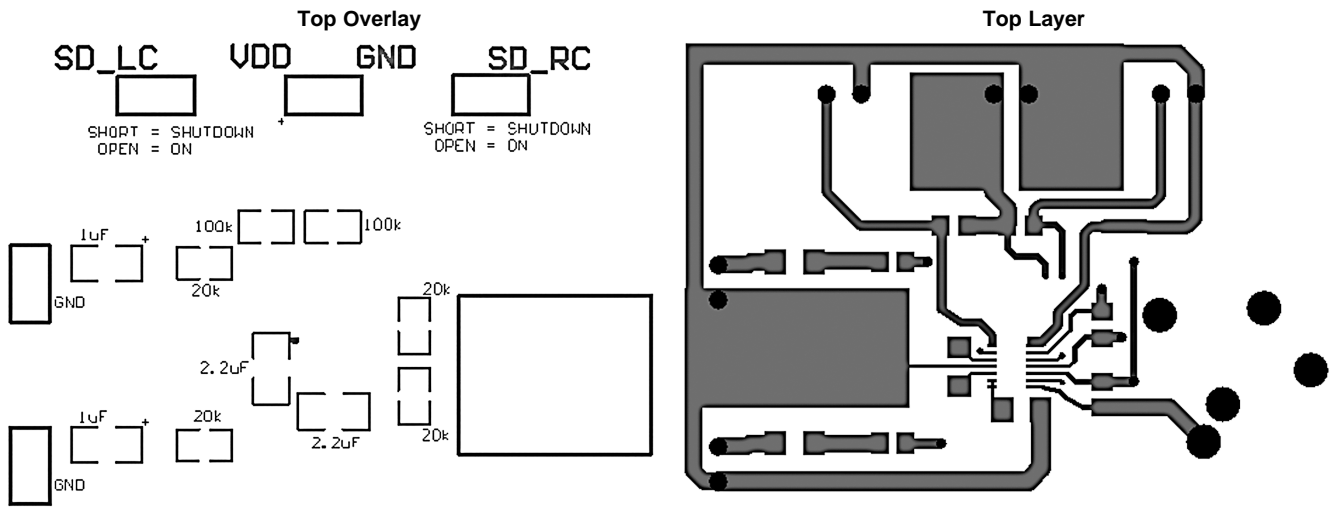

**NATIONAL SEMICONDUCTOR**  
LM4917SD Audio Power Amplifier

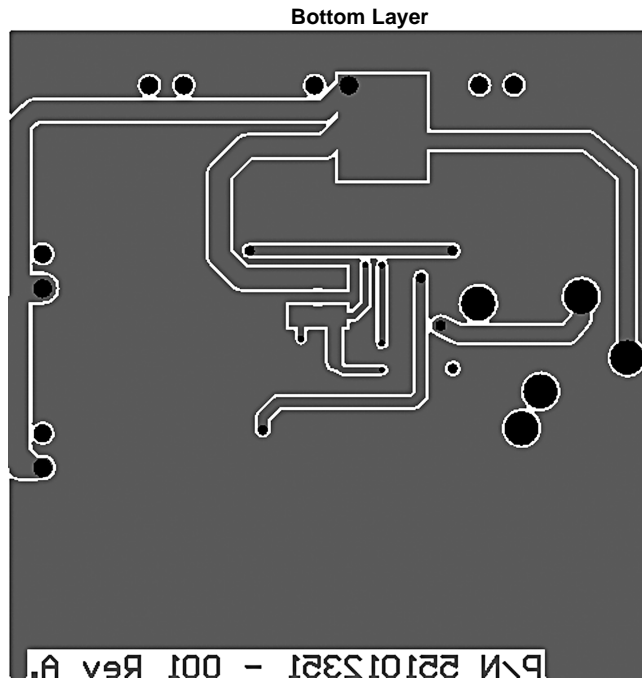

## LM4917 Reference Design Boards Bill Of Materials

Part Description	Qty	Ref Designator
LM4917 Mono Reference Design Board	1	
LM4917 Audio AMP	1	U1
Tantalum Cap 1 $\mu$ F 16V 10	1	Cs
Ceramic Cap 0.39 $\mu$ F 50V Z50 20	2	Ci
Resistor 20k $\Omega$ 1/10W 5	4	Ri, Rf
Resistor 100k $\Omega$ 1/10W 5	1	Rpu
Jumper Header Vertical Mount 2X1, 0.100	1	J1

### PCB Layout Guidelines

This section provides practical guidelines for mixed signal PCB layout that involves various digital/analog power and ground traces. Designers should note that these are only "rule-of-thumb" recommendations and the actual results will depend heavily on the final layout.

#### Avoiding Shorts on the Charge Pump Outputs

For the LM4917SD package, the exposed dap is connected to the substrate of the device. Because LM4917's charge pump is powered by both a negative and positive supply the exposed dap must be left floating. This will avoid shorting the charge pump outputs.

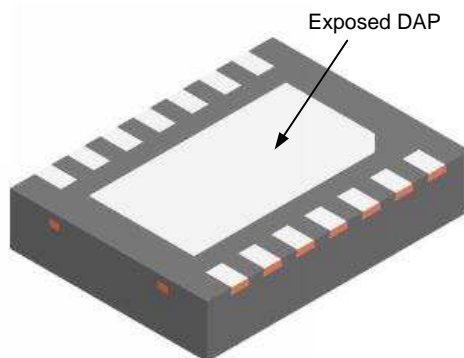

**Figure 30. Bottom View of LM4917SD Package**

#### Minimization of THD

PCB trace impedance on the power, ground, and all output traces should be minimized to achieve optimal THD performance. Therefore, use PCB traces that are as wide as possible for these connections. As the gain of the amplifier is increased, the trace impedance will have an ever increasing adverse affect on THD performance. At unity-gain (0dB) the parasitic trace impedance effect on THD performance is reduced but still a negative factor in the THD performance of the LM4917 in a given application.

#### General Mixed Signal Layout Recommendation

##### Power and Ground Circuits

For two layer mixed signal design, it is important to isolate the digital power and ground trace paths from the analog power and ground trace paths. Star trace routing techniques (bringing individual traces back to a central point rather than daisy chaining traces together in a serial manner) can greatly enhance low level signal performance. Star trace routing refers to using individual traces to feed power and ground to each circuit or even device. This technique will require a greater amount of design time, but will not increase the final price of the board. The only extra parts required may be some jumpers.

### **Single-Point Power / Ground Connections**

The analog power traces should be connected to the digital traces through a single point (link). A "PI-filter" can be helpful in minimizing high frequency noise coupling between the analog and digital sections. Further, place digital and analog power traces over the corresponding digital and analog ground traces to minimize noise coupling.

### **Placement of Digital and Analog Components**

All digital components and high-speed digital signal traces should be located as far away as possible from analog components and circuit traces.

### **Avoiding Typical Design / Layout Problems**

Avoid ground loops or running digital and analog traces parallel to each other (side-by-side) on the same PCB layer. When traces must cross over each other do it at 90 degrees. Running digital and analog traces at 90 degrees to each other from the top to the bottom side as much as possible will minimize capacitive noise coupling and cross talk.

## PACKAGING INFORMATION

Orderable Device	Status (1)	Package Type	Package Drawing	Pins	Package Qty	Eco Plan (2)	Lead/Ball Finish	MSL Peak Temp (3)	Op Temp (°C)	Top-Side Markings (4)	Samples
LM4917MT/NOPB	ACTIVE	TSSOP	PW	14	94	Green (RoHS & no Sb/Br)	CU SN	Level-1-260C-UNLIM	-40 to 85	L4917 MT	<a href="#">Samples</a>
LM4917MTX/NOPB	ACTIVE	TSSOP	PW	14	2500	Green (RoHS & no Sb/Br)	CU SN	Level-1-260C-UNLIM	-40 to 85	L4917 MT	<a href="#">Samples</a>
LM4917SD/NOPB	ACTIVE	WSON	NHK	14	1000	Green (RoHS & no Sb/Br)	CU SN	Level-1-260C-UNLIM	-40 to 85	L4917	<a href="#">Samples</a>

(1) The marketing status values are defined as follows:

**ACTIVE:** Product device recommended for new designs.

**LIFEBUY:** TI has announced that the device will be discontinued, and a lifetime-buy period is in effect.

**NRND:** Not recommended for new designs. Device is in production to support existing customers, but TI does not recommend using this part in a new design.

**PREVIEW:** Device has been announced but is not in production. Samples may or may not be available.

**OBSOLETE:** TI has discontinued the production of the device.

(2) Eco Plan - The planned eco-friendly classification: Pb-Free (RoHS), Pb-Free (RoHS Exempt), or Green (RoHS & no Sb/Br) - please check <http://www.ti.com/productcontent> for the latest availability information and additional product content details.

**TBD:** The Pb-Free/Green conversion plan has not been defined.

**Pb-Free (RoHS):** TI's terms "Lead-Free" or "Pb-Free" mean semiconductor products that are compatible with the current RoHS requirements for all 6 substances, including the requirement that lead not exceed 0.1% by weight in homogeneous materials. Where designed to be soldered at high temperatures, TI Pb-Free products are suitable for use in specified lead-free processes.

**Pb-Free (RoHS Exempt):** This component has a RoHS exemption for either 1) lead-based flip-chip solder bumps used between the die and package, or 2) lead-based die adhesive used between the die and leadframe. The component is otherwise considered Pb-Free (RoHS compatible) as defined above.

**Green (RoHS & no Sb/Br):** TI defines "Green" to mean Pb-Free (RoHS compatible), and free of Bromine (Br) and Antimony (Sb) based flame retardants (Br or Sb do not exceed 0.1% by weight in homogeneous material)

(3) MSL, Peak Temp. -- The Moisture Sensitivity Level rating according to the JEDEC industry standard classifications, and peak solder temperature.

(4) Only one of markings shown within the brackets will appear on the physical device.

**Important Information and Disclaimer:** The information provided on this page represents TI's knowledge and belief as of the date that it is provided. TI bases its knowledge and belief on information provided by third parties, and makes no representation or warranty as to the accuracy of such information. Efforts are underway to better integrate information from third parties. TI has taken and continues to take reasonable steps to provide representative and accurate information but may not have conducted destructive testing or chemical analysis on incoming materials and chemicals. TI and TI suppliers consider certain information to be proprietary, and thus CAS numbers and other limited information may not be available for release.

In no event shall TI's liability arising out of such information exceed the total purchase price of the TI part(s) at issue in this document sold by TI to Customer on an annual basis.

PW (R-PDSO-G14)

PLASTIC SMALL OUTLINE



- NOTES:
- A. All linear dimensions are in millimeters. Dimensioning and tolerancing per ASME Y14.5M-1994.
  - B. This drawing is subject to change without notice.
  - C. Body length does not include mold flash, protrusions, or gate burrs. Mold flash, protrusions, or gate burrs shall not exceed 0,15 each side.
  - D. Body width does not include interlead flash. Interlead flash shall not exceed 0,25 each side.
  - E. Falls within JEDEC MO-153



## IMPORTANT NOTICE

Texas Instruments Incorporated and its subsidiaries (TI) reserve the right to make corrections, enhancements, improvements and other changes to its semiconductor products and services per JESD46, latest issue, and to discontinue any product or service per JESD48, latest issue. Buyers should obtain the latest relevant information before placing orders and should verify that such information is current and complete. All semiconductor products (also referred to herein as "components") are sold subject to TI's terms and conditions of sale supplied at the time of order acknowledgment.

TI warrants performance of its components to the specifications applicable at the time of sale, in accordance with the warranty in TI's terms and conditions of sale of semiconductor products. Testing and other quality control techniques are used to the extent TI deems necessary to support this warranty. Except where mandated by applicable law, testing of all parameters of each component is not necessarily performed.

TI assumes no liability for applications assistance or the design of Buyers' products. Buyers are responsible for their products and applications using TI components. To minimize the risks associated with Buyers' products and applications, Buyers should provide adequate design and operating safeguards.

TI does not warrant or represent that any license, either express or implied, is granted under any patent right, copyright, mask work right, or other intellectual property right relating to any combination, machine, or process in which TI components or services are used. Information published by TI regarding third-party products or services does not constitute a license to use such products or services or a warranty or endorsement thereof. Use of such information may require a license from a third party under the patents or other intellectual property of the third party, or a license from TI under the patents or other intellectual property of TI.

Reproduction of significant portions of TI information in TI data books or data sheets is permissible only if reproduction is without alteration and is accompanied by all associated warranties, conditions, limitations, and notices. TI is not responsible or liable for such altered documentation. Information of third parties may be subject to additional restrictions.

Resale of TI components or services with statements different from or beyond the parameters stated by TI for that component or service voids all express and any implied warranties for the associated TI component or service and is an unfair and deceptive business practice. TI is not responsible or liable for any such statements.

Buyer acknowledges and agrees that it is solely responsible for compliance with all legal, regulatory and safety-related requirements concerning its products, and any use of TI components in its applications, notwithstanding any applications-related information or support that may be provided by TI. Buyer represents and agrees that it has all the necessary expertise to create and implement safeguards which anticipate dangerous consequences of failures, monitor failures and their consequences, lessen the likelihood of failures that might cause harm and take appropriate remedial actions. Buyer will fully indemnify TI and its representatives against any damages arising out of the use of any TI components in safety-critical applications.

In some cases, TI components may be promoted specifically to facilitate safety-related applications. With such components, TI's goal is to help enable customers to design and create their own end-product solutions that meet applicable functional safety standards and requirements. Nonetheless, such components are subject to these terms.

No TI components are authorized for use in FDA Class III (or similar life-critical medical equipment) unless authorized officers of the parties have executed a special agreement specifically governing such use.

Only those TI components which TI has specifically designated as military grade or "enhanced plastic" are designed and intended for use in military/aerospace applications or environments. Buyer acknowledges and agrees that any military or aerospace use of TI components which have **not** been so designated is solely at the Buyer's risk, and that Buyer is solely responsible for compliance with all legal and regulatory requirements in connection with such use.

TI has specifically designated certain components as meeting ISO/TS16949 requirements, mainly for automotive use. In any case of use of non-designated products, TI will not be responsible for any failure to meet ISO/TS16949.

### Products

Audio	<a href="http://www.ti.com/audio">www.ti.com/audio</a>
Amplifiers	<a href="http://amplifier.ti.com">amplifier.ti.com</a>
Data Converters	<a href="http://dataconverter.ti.com">dataconverter.ti.com</a>
DLP® Products	<a href="http://www.dlp.com">www.dlp.com</a>
DSP	<a href="http://dsp.ti.com">dsp.ti.com</a>
Clocks and Timers	<a href="http://www.ti.com/clocks">www.ti.com/clocks</a>
Interface	<a href="http://interface.ti.com">interface.ti.com</a>
Logic	<a href="http://logic.ti.com">logic.ti.com</a>
Power Mgmt	<a href="http://power.ti.com">power.ti.com</a>
Microcontrollers	<a href="http://microcontroller.ti.com">microcontroller.ti.com</a>
RFID	<a href="http://www.ti-rfid.com">www.ti-rfid.com</a>
OMAP Applications Processors	<a href="http://www.ti.com/omap">www.ti.com/omap</a>
Wireless Connectivity	<a href="http://www.ti.com/wirelessconnectivity">www.ti.com/wirelessconnectivity</a>

### Applications

Automotive and Transportation	<a href="http://www.ti.com/automotive">www.ti.com/automotive</a>
Communications and Telecom	<a href="http://www.ti.com/communications">www.ti.com/communications</a>
Computers and Peripherals	<a href="http://www.ti.com/computers">www.ti.com/computers</a>
Consumer Electronics	<a href="http://www.ti.com/consumer-apps">www.ti.com/consumer-apps</a>
Energy and Lighting	<a href="http://www.ti.com/energy">www.ti.com/energy</a>
Industrial	<a href="http://www.ti.com/industrial">www.ti.com/industrial</a>
Medical	<a href="http://www.ti.com/medical">www.ti.com/medical</a>
Security	<a href="http://www.ti.com/security">www.ti.com/security</a>
Space, Avionics and Defense	<a href="http://www.ti.com/space-avionics-defense">www.ti.com/space-avionics-defense</a>
Video and Imaging	<a href="http://www.ti.com/video">www.ti.com/video</a>

### TI E2E Community

[e2e.ti.com](http://e2e.ti.com)