

## LM49120 **Boomer**® Audio Power Amplifier Series Audio Sub-System with Mono Class AB Loudspeaker Amplifier and Stereo OCL/SE Headphone Amplifier

Check for Samples: [LM49120](#), [LM49120TLEVAL](#)

### FEATURES

- RF immunity
- Selectable OCL/SE headphone drivers
- 32 Step volume control
- Click and Pop suppression
- Independent speaker and headphone gain settings
- Minimum external components
- Thermal over load protection
- Micro-power shutdown
- Space saving 16–bump micro SMD package
- Thermal shutdown protection
- Micro-power shutdown
- I<sup>2</sup>C Control Interface

### APPLICATIONS

- Mobile Phones
- PDAs
- Portable Electronics

### DESCRIPTION

The LM49120 is a compact audio subsystem designed for portable handheld applications such as cellular phones. The LM49120 combines a mono 1.3W speaker amplifier, stereo 85mW/ch output capacitorless headphone amplifier, 32 step volume control, and an input mixer/multiplexer into a single 16–bump micro SMD package.

The LM49120 has three input channels: two single-ended stereo inputs and a differential mono input. Each input features a 32-step digital volume control. The headphone output stage features an 8 step (-18dB – 0dB) attenuator, while the speaker output stage has two selectable (0dB/+6dB) gain settings. The digital volume control and mode control are programmed through a two-wire I<sup>2</sup>C compatible interface.

**Table 1. Key Specifications**

	VALUE	UNIT
Output power at V <sub>DD</sub> = 5V:		
Speaker: R <sub>L</sub> = 8Ω BTL, THD+N ≤ 1%	1.3	W (typ)
Headphone: R <sub>L</sub> = 32Ω, SE, THD+N ≤ 1%	85	mW (typ)
Output power at V <sub>DD</sub> = 3.6V:		
Speaker: R <sub>L</sub> = 8Ω, BTL, THD+N ≤ 1%	63	2mW (typ)
Output power at V <sub>DD</sub> = 3.3V:		
Speaker: R <sub>L</sub> = 8Ω, BTL, THD+N ≤ 1%	540	mW (typ)
Headphone: R <sub>L</sub> = 32Ω, OCL/SE, THD+N ≤ 1%	35	mW (typ)



Please be aware that an important notice concerning availability, standard warranty, and use in critical applications of Texas Instruments semiconductor products and disclaimers thereto appears at the end of this data sheet.

All trademarks are the property of their respective owners.

Typical Application

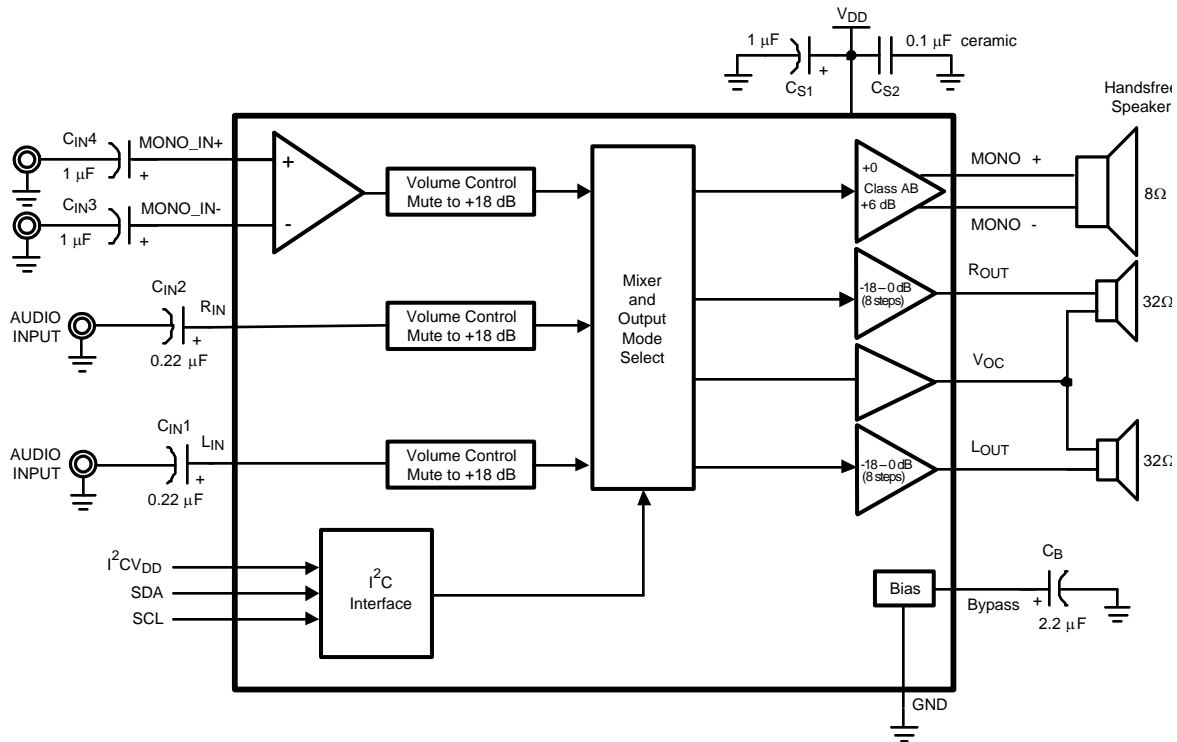
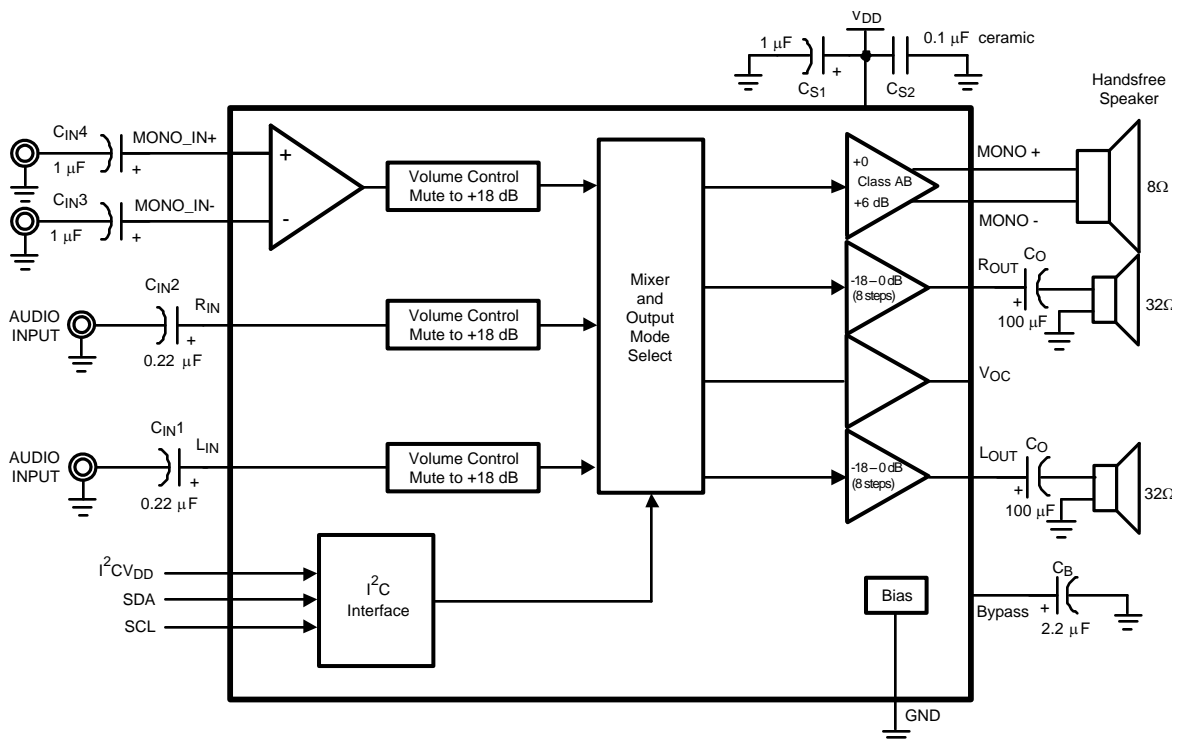

Figure 1. Output Capacitor-less Configuration



The 6dB speaker gain applies only to the differential input path.

Figure 2. Single-Ended Configuration

**Connection Diagram**

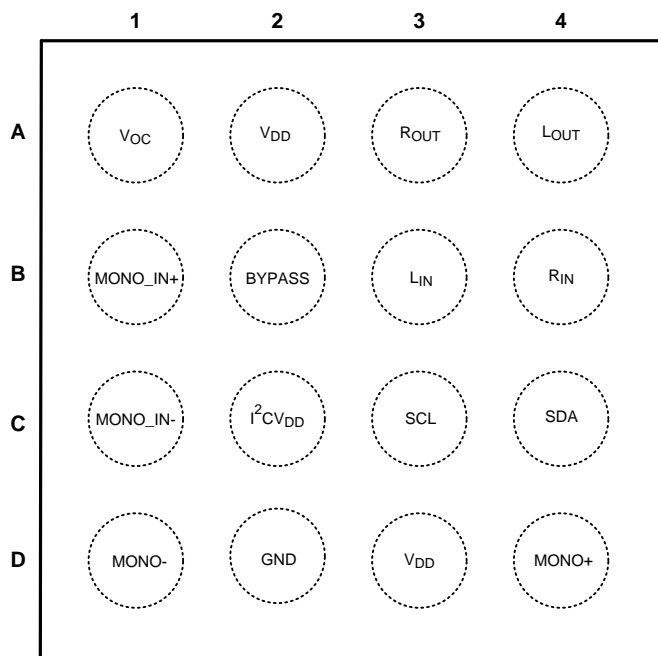

**Figure 3. Top View  
(Bump-Side Down)  
16 Bump micro SMD Package**

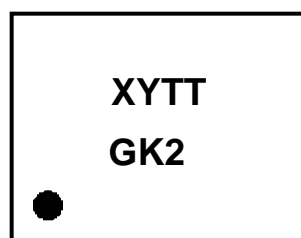

**Figure 4. Top View  
XY - Date Code  
TT - Die Traceability  
G- Boomer  
K2 - LM49120TL**

**Table 2. Pin Descriptions**

Bump	Name	Description
A1	V <sub>OC</sub>	Headphone Center Amplifier Output
A2	V <sub>DD</sub>	Headphone Power Supply
A3	R <sub>OUT</sub>	Right Channel Headphone Output
A4	L <sub>OUT</sub>	Left Channel Headphone Output
B1	MONO_IN+	Mono Non-inverting Input
B2	BYPASS	Bias Bypass
B3	L <sub>IN</sub>	Left Channel Input
B4	R <sub>IN</sub>	Right Channel Input
C1	MONO_IN-	Mono Inverting Input
C2	I <sup>2</sup> CV <sub>DD</sub>	I <sup>2</sup> C Interface Power Supply
C3	SCL	I <sup>2</sup> C Clock Input
C4	SDA	I <sup>2</sup> C Data Input
D1	MONO-	Loudspeaker Inverting Output
D2	GND	Ground
D3	V <sub>DD</sub>	Power Supply
D4	MONO+	Loudspeaker Non-inverting Output



These devices have limited built-in ESD protection. The leads should be shorted together or the device placed in conductive foam during storage or handling to prevent electrostatic damage to the MOS gates.

**Absolute Maximum Ratings** <sup>(1)</sup> <sup>(2)</sup>

Supply Voltage (Note 1)	6.0V
Storage Temperature	-65°C to +150°C
Input Voltage	-0.3 to V <sub>DD</sub> +0.3
Power Dissipation (Note 3)	Internally Limited
ESD Rating (Note 4)	2000V
ESD Rating (Note 5)	200V
Junction Temperature	150°C
Solder Information	
Vapor Phase (60 sec.)	215°C
Infrared (15 sec.)	220°C
Thermal Resistance	
θ <sub>JA</sub> (typ) - TLA	62.3°C/W

- (1) “*Absolute Maximum Ratings*” indicate limits beyond which damage to the device may occur, including inoperability and degradation of device reliability and/or performance. Functional operation of the device and/or non-degradation at the *Absolute Maximum Ratings* or other conditions beyond those indicated in the *Recommended Operating Conditions* is not implied. The *Recommended Operating Conditions* indicate conditions at which the device is functional and the device should not be operated beyond such conditions. All voltages are measured with respect to the ground pin, unless otherwise specified.
- (2) The *Electrical Characteristics* tables list guaranteed specifications under the listed *Recommended Operating Conditions* except as otherwise modified or specified by the *Electrical Characteristics Conditions* and/or Notes. Typical specifications are estimations only and are not guaranteed.

**Operating Ratings**

Temperature Range	-40°C to 85°C
Supply Voltage (V <sub>DD</sub> )	2.7V ≤ V <sub>DD</sub> ≤ 5.5V
Supply Voltage (I <sup>2</sup> CV <sub>DD</sub> )	1.7V ≤ I <sup>2</sup> CV <sub>DD</sub> ≤ 5.5V

**Electrical Characteristics 3.3V** <sup>(1)</sup> <sup>(2)</sup>

 The following specifications apply for  $V_{DD} = 3.3V$ ,  $T_A = 25^\circ C$ , all volume controls set to 0dB, unless otherwise specified.

Symbol	Parameter	Conditions	LM49120		Units (Limits)
			Typical <sup>(3)</sup>	Limits <sup>(4)</sup>	
$I_{DD}$	Supply Current	$V_{IN} = 0$ , No Load			
		Output mode 5, 6, 7, 9, 10, 11, 13, 14, 15 OCL Headphone	6.2	8.0	mA (max)
		Output mode 5, 6, 7, 9, 10, 11, 13, 14, 15 SE Headphone	5.5		mA
		Output mode 1, 2, 3 OCL Headphone	4.1	5.3	mA (max)
		Output mode 1, 2, 3 SE Headphone	5.5		mA
		Output mode 4, 8, 12 OCL Headphone	3.7	4.7	mA (max)
		Output mode 4, 8, 12 SE Headphone	3.0		mA
$I_{SD}$	Shutdown Current	Shutdown Mode 0	0.01	1	$\mu A$
$V_{OS}$	Output Offset Voltage	$V_{IN} = 0V$ , Output Mode 10, LS output	10		mV
		$V_{IN} = 0V$ , Output Mode 10, HP output, (OCL), 0dB (HP Output Gain)	1.5	5	mV (max)
$P_O$	Output Power	LS <sub>OUT</sub> ; $R_L = 8\Omega$ THD+N = 1%; $f = 1kHz$ , BTL, Mode 1	540	500	mW (min)
		L <sub>OUT</sub> and R <sub>OUT</sub> ; $R_L = 32\Omega$ THD+N = 1%; $f = 1kHz$ , OCL, Mode 8	35	30	mW (min)
THD+N	Total Harmonic Distortion + Noise	MONO <sub>OUT</sub> $f = 1kHz$ $P_{OUT} = 250mW$ ; $R_L = 8\Omega$ , BTL, Mode 1	0.05		%
		L <sub>OUT</sub> and R <sub>OUT</sub> ; $f = 1kHz$ $P_{OUT} = 12mW$ ; $R_L = 32\Omega$ , SE, Mode 8	0.015		%
		L <sub>OUT</sub> and R <sub>OUT</sub> ; $f = 1kHz$ $P_{OUT} = 12mW$ ; $R_L = 32\Omega$ , OCL, Mode 8	0.015		%
$e_{OUT}$	Output Noise	A-weighted, inputs terminated to GND, Output referred			
		Speaker Amplifier; Mode 1	15		$\mu V$
		Speaker Amplifier; Mode 2	24		$\mu V$
		Speaker Amplifier; Mode 3	29		$\mu V$
		Headphone Amplifier; SE, Mode 4	8		$\mu V$
		Headphone Amplifier; SE, Mode 8	8		$\mu V$
		Headphone Amplifier; SE, Mode 12	11		$\mu V$
		Headphone Amplifier; OCL, Mode 4	8		$\mu V$
		Headphone Amplifier; OCL, Mode 8	9		$\mu V$
Headphone Amplifier; OCL, Mode 12	12		$\mu V$		

- (1) "Absolute Maximum Ratings" indicate limits beyond which damage to the device may occur, including inoperability and degradation of device reliability and/or performance. Functional operation of the device and/or non-degradation at the *Absolute Maximum Ratings* or other conditions beyond those indicated in the *Recommended Operating Conditions* is not implied. The *Recommended Operating Conditions* indicate conditions at which the device is functional and the device should not be operated beyond such conditions. All voltages are measured with respect to the ground pin, unless otherwise specified.
- (2) The *Electrical Characteristics* tables list guaranteed specifications under the listed *Recommended Operating Conditions* except as otherwise modified or specified by the *Electrical Characteristics Conditions* and/or Notes. Typical specifications are estimations only and are not guaranteed.
- (3) Typical values represent most likely parametric norms at  $T_A = +25^\circ C$ , and at the *Recommended Operation Conditions* at the time of product characterization and are not guaranteed.
- (4) Datasheet min/max specification limits are guaranteed by test or statistical analysis.

**Electrical Characteristics 3.3V <sup>(1)</sup> <sup>(2)</sup> (continued)**

The following specifications apply for  $V_{DD} = 3.3V$ ,  $T_A = 25^\circ C$ , all volume controls set to 0dB, unless otherwise specified.

Symbol	Parameter	Conditions	LM49120		Units (Limits)
			Typical <sup>(3)</sup>	Limits <sup>(4)</sup>	
PSRR	Power Supply Rejection Ratio	$V_{RIPPLE} = 200mV_{PP}$ ; $f_{RIPPLE} = 217Hz$ , $R_L = 8\Omega$ (Speaker); $R_L = 32\Omega$ (Headphone) $C_B = 2.2\mu F$ , BTL All audio inputs terminated to GND; output referred			
		Speaker Output; Speaker Output Gain 6dB			
		Speaker Amplifier; Mode 1	79		dB
		Speaker Amplifier; Mode 2	63		dB
		Speaker Amplifier; Mode 3	62		dB
		Speaker Amplifier Output; Speaker Output Gain 0dB			
		Speaker Amplifier; Mode 1	84		dB
		Speaker Amplifier; Mode 2	63		dB
		Speaker Amplifier; Mode 3	62		dB
		Headphone Amplifier Output			
		Headphone Amplifier; SE, Mode 4	83		dB
		Headphone Amplifier; SE, Mode 8	84		dB
		Headphone Amplifier; SE, Mode 12	78		dB
		Headphone Amplifier; OCL, Mode 4	83		dB
Headphone Amplifier; OCL, Mode 8	80		dB		
Headphone Amplifier; OCL, Mode 12	77		dB		
$VOL_E$	Volume Control Step Size Error		$\pm 0.2$		dB
$VOL_{RANGE}$	Digital Volume Control Range	Maximum Attenuation	-86	-91 -81	dB (min) dB (max)
		Maximum Gain	18	17.4 18.6	dB (min) dB (max)
$A_{U(HP)}$	HP (SE) Mute Attenuation	Output Mode 1, 2, 3	96		dB
$Z_{IN}$	MONO_IN Input Impedance $L_{IN}$ and $R_{IN}$ Input Impedance	Maximum gain setting	12.5	10 15	k $\Omega$ (min) k $\Omega$ (max)
		Maximum attenuation setting	110	90 130	k $\Omega$ (min) k $\Omega$ (max)
CMRR	Common-Mode Rejection Ratio	$f = 217Hz$ , $V_{CM} = 1V_{PP}$ , Speaker, BTL, Mode 1, $R_L = 8\Omega$ Differential Input	61		dB
		$f = 217Hz$ , $V_{CM} = 1V_{PP}$ , Headphone, OCL, Mode 4, $R_L = 32\Omega$ Stereo Input	66		dB
$X_{TALK}$	Crosstalk	Headphone; $P_{OUT} = 12mW$ $f = 1kHz$ , OCL, Mode 8	-60		dB
		Headphone; $P_{OUT} = 12mW$ $f = 1kHz$ , SE, Mode 8	-72		dB
$T_{WU}$	Wake-Up Time from Shutdown	$C_B = 4.7\mu F$ , OCL	35		ms
		$C_B = 2.2\mu F$ , SE, Normal Turn On Mode Turn_On_Time = 1	120		ms
		$C_B = 2.2\mu F$ , OCL	30		ms
		$C_B = 4.7\mu F$ , SE, Fast Turn On Mode Turn_On_Time = 0	130		ms

**Electrical Characteristics 5.0V** <sup>(1) (2)</sup>

The following specifications apply for  $V_{DD} = 5.0V$ ,  $T_A = 25^\circ C$ , all volume controls set to 0dB, unless otherwise specified.

Symbol	Parameter	Conditions	LM49120		Units (Limits)
			Typical <sup>(3)</sup>	Limits <sup>(4)</sup>	
$I_{DD}$	Supply Current	$V_{IN} = 0$ , No Load			
		Output mode 5, 6, 7, 9, 10, 11, 13, 14, 15 OCL Headphone	7.2		mA
		Output mode 5, 6, 7, 9, 10, 11, 13, 14, 15 SE Headphone	6.4		mA
		Output mode 1, 2, 3 OCL Headphone	6.4		mA
		Output mode 1, 2, 3 SE Headphone	4.8		mA
		Output mode 4, 8, 12 OCL Headphone	4.4		mA
		Output mode 4, 8, 12 SE Headphone	3.5		mA
$I_{SD}$	Shutdown Current	Shutdown Mode 0	0.01		$\mu A$
$V_{OS}$	Output Offset Voltage	$V_{IN} = 0V$ , Output Mode 10, LS output	10		mV
		$V_{IN} = 0V$ , Output Mode 10, HP output, (OCL), 0dB (HP Output Gain)	1.5		mV
$P_O$	Output Power	LS $P_{OUT}$ ; $R_L = 8\Omega$ THD+N = 1%; $f = 1kHz$ , BTL, Mode 1	1.3		W
		L $P_{OUT}$ and R $P_{OUT}$ ; $R_L = 32\Omega$ THD+N = 1%; $f = 1kHz$ , OCL, Mode 8	85		mW
THD+N	Total Harmonic Distortion + Noise	LS $P_{OUT}$ $f = 1kHz$ $P_{OUT} = 250mW$ ; $R_L = 8\Omega$ , BTL, Mode 1	0.05		%
		L $P_{OUT}$ and R $P_{OUT}$ ; $f = 1kHz$ $P_{OUT} = 12mW$ ; $R_L = 32\Omega$ , SE, Mode 8	0.015		%
		L $P_{OUT}$ and R $P_{OUT}$ ; $f = 1kHz$ $P_{OUT} = 12mW$ ; $R_L = 32\Omega$ , OCL, Mode 8	0.015		%
$e_{OUT}$	Output Noise	A-weighted, inputs terminated to GND, Output referred			
		Speaker Amplifier; Mode 1	17		$\mu V$
		Speaker Amplifier; Mode 2	27		$\mu V$
		Speaker Amplifier; Mode 3	33		$\mu V$
		Headphone Amplifier; SE, Mode 4	8		$\mu V$
		Headphone Amplifier; SE, Mode 8	8		$\mu V$
		Headphone Amplifier; SE, Mode 12	12		$\mu V$
		Headphone Amplifier; OCL, Mode 4	9		$\mu V$
		Headphone Amplifier; OCL, Mode 8	9		$\mu V$
Headphone Amplifier; OCL, Mode 12	12		$\mu V$		

- (1) "Absolute Maximum Ratings" indicate limits beyond which damage to the device may occur, including inoperability and degradation of device reliability and/or performance. Functional operation of the device and/or non-degradation at the Absolute Maximum Ratings or other conditions beyond those indicated in the Recommended Operating Conditions is not implied. The Recommended Operating Conditions indicate conditions at which the device is functional and the device should not be operated beyond such conditions. All voltages are measured with respect to the ground pin, unless otherwise specified.
- (2) The Electrical Characteristics tables list guaranteed specifications under the listed Recommended Operating Conditions except as otherwise modified or specified by the Electrical Characteristics Conditions and/or Notes. Typical specifications are estimations only and are not guaranteed.
- (3) Typical values represent most likely parametric norms at  $T_A = +25^\circ C$ , and at the Recommended Operation Conditions at the time of product characterization and are not guaranteed.
- (4) Datasheet min/max specification limits are guaranteed by test or statistical analysis.

**Electrical Characteristics 5.0V** <sup>(1)</sup> <sup>(2)</sup> (continued)

The following specifications apply for  $V_{DD} = 5.0V$ ,  $T_A = 25^\circ C$ , all volume controls set to 0dB, unless otherwise specified.

Symbol	Parameter	Conditions	LM49120		Units (Limits)
			Typical <sup>(3)</sup>	Limits <sup>(4)</sup>	
PSRR	Power Supply Rejection Ratio	$V_{RIPPLE} = 200mV_{PP}$ ; $f_{RIPPLE} = 217Hz$ , $R_L = 8\Omega$ (Speaker); $R_L = 32\Omega$ (Headphone) $C_B = 2.2\mu F$ , BTL All audio inputs terminated to GND; output referred			
		Speaker Output; Speaker Output Gain 6dB			
		Speaker Amplifier; Mode 1	69		dB
		Speaker Amplifier; Mode 2	60		dB
		Speaker Amplifier; Mode 3	58		dB
		Speaker Amplifier Output; Speaker Output Gain 0dB			
		Speaker Amplifier; Mode 1	84		dB
		Speaker Amplifier; Mode 2	63		dB
		Speaker Amplifier; Mode 3	62		dB
		Headphone Amplifier Output			
		Headphone Amplifier; SE, Mode 4	75		dB
		Headphone Amplifier; SE, Mode 8	75		dB
		Headphone Amplifier; SE, Mode 12	72		dB
		Headphone Amplifier; OCL, Mode 4	75		dB
		Headphone Amplifier; OCL, Mode 8	75		dB
Headphone Amplifier; OCL, Mode 12	72		dB		
$VOL_{\epsilon}$	Volume Control Step Size Error		$\pm 0.2$		dB
$VOL_{RANGE}$	Digital Volume Control Range	Maximum Attenuation	-86	-91 -81	dB dB
		Maximum Gain	18		dB dB
$A_{u(HP)}$	HP (SE) Mute Attenuation	Output Mode 1, 2, 3	96		dB
$Z_{IN}$	MONO_IN Input Impedance $L_{IN}$ and $R_{IN}$ Input Impedance	Maximum gain setting	12.5		k $\Omega$ k $\Omega$
		Maximum attenuation setting	110		k $\Omega$ k $\Omega$
CMRR	Common-Mode Rejection Ratio	$f = 217Hz$ , $V_{CM} = 1V_{PP}$ , Speaker, BTL, Mode 1, $R_L = 8\Omega$ Differential Input	61		dB
		$f = 217Hz$ , $V_{CM} = 1V_{PP}$ , Headphone, OCL, Mode 4, $R_L = 32\Omega$ Stereo Input	66		dB
$X_{TALK}$	Crosstalk	Headphone; $P_{OUT} = 12mW$ $f = 1kHz$ , OCL, Mode 8	-54		dB
		Headphone; $P_{OUT} = 12mW$ $f = 1kHz$ , SE, Mode 8	-72		dB
$T_{WU}$	Wake-Up Time from Shutdown	$C_B = 4.7\mu F$ , OCL	28		ms
		$C_B = 2.2\mu F$ , SE, Normal Turn On Mode Turn_On_Time = 1	151		ms
		$C_B = 2.2\mu F$ , OCL	25		ms
		$C_B = 4.7\mu F$ , SE, Fast Turn On Mode Turn_On_Time = 0	168		ms

**I<sup>2</sup>C Timing Characteristics  $2.2V \leq I^2C_{V_{DD}} \leq 5.5V$ , <sup>(1)</sup> <sup>(2)</sup>**

The following specifications apply for  $V_{DD} = 5.0V$  and  $3.3V$ ,  $T_A = 25^\circ C$ ,  $2.2V \leq I^2C_{V_{DD}} \leq 5.5V$ , unless otherwise specified.

Symbol	Parameter	Conditions	LM49120		Units (Limits)
			Typical <sup>(3)</sup>	Limits <sup>(4)</sup>	
t <sub>1</sub>	I <sup>2</sup> C Clock Period			2.5	μs (min)
t <sub>2</sub>	I <sup>2</sup> C Data Setup Time			100	ns (min)
t <sub>3</sub>	I <sup>2</sup> C Data Stable Time			0	ns (min)
t <sub>4</sub>	Start Condition Time			100	ns (min)
t <sub>5</sub>	Stop Condition Time			100	ns (min)
t <sub>6</sub>	I <sup>2</sup> C Data Hold Time			100	ns (min)
V <sub>IH</sub>	I <sup>2</sup> C Input Voltage High			0.7xI <sup>2</sup> CV <sub>DD</sub>	V (min)
V <sub>IL</sub>	I <sup>2</sup> C Input Voltage Low			0.3xI <sup>2</sup> CV <sub>DD</sub>	V (max)

- (1) “*Absolute Maximum Ratings*” indicate limits beyond which damage to the device may occur, including inoperability and degradation of device reliability and/or performance. Functional operation of the device and/or non-degradation at the *Absolute Maximum Ratings* or other conditions beyond those indicated in the *Recommended Operating Conditions* is not implied. The *Recommended Operating Conditions* indicate conditions at which the device is functional and the device should not be operated beyond such conditions. All voltages are measured with respect to the ground pin, unless otherwise specified.
- (2) The *Electrical Characteristics* tables list guaranteed specifications under the listed *Recommended Operating Conditions* except as otherwise modified or specified by the *Electrical Characteristics Conditions* and/or Notes. Typical specifications are estimations only and are not guaranteed.
- (3) Typical values represent most likely parametric norms at  $T_A = +25^\circ C$ , and at the *Recommended Operation Conditions* at the time of product characterization and are not guaranteed.
- (4) Datasheet min/max specification limits are guaranteed by test or statistical analysis.

### I<sup>2</sup>C Timing Characteristics 1.7V ≤ I<sup>2</sup>C\_V<sub>DD</sub> ≤ 2.2V<sup>(1) (2)</sup>

The following specifications apply for V<sub>DD</sub> = 5.0V and 3.3V, T<sub>A</sub> = 25°C, 1.7V ≤ I<sup>2</sup>C\_V<sub>DD</sub> ≤ 2.2V, unless otherwise specified.

Symbol	Parameter	Conditions	LM49120		Units (Limits)
			Typical <sup>(3)</sup>	Limits <sup>(4)</sup>	
t <sub>1</sub>	I <sup>2</sup> C Clock Period			2.5	μs (min)
t <sub>2</sub>	I <sup>2</sup> C Data Setup Time			250	ns (min)
t <sub>3</sub>	I <sup>2</sup> C Data Stable Time			0	ns (min)
t <sub>4</sub>	Start Condition Time			250	ns (min)
t <sub>5</sub>	Stop Condition Time			250	ns (min)
t <sub>6</sub>	I <sup>2</sup> C Data Hold Time			250	ns (min)
V <sub>IH</sub>	I <sup>2</sup> C Input Voltage High			0.7xI <sup>2</sup> CV <sub>DD</sub>	V (min)
V <sub>IL</sub>	I <sup>2</sup> C Input Voltage Low			0.3xI <sup>2</sup> CV <sub>DD</sub>	V (max)

- (1) “*Absolute Maximum Ratings*” indicate limits beyond which damage to the device may occur, including inoperability and degradation of device reliability and/or performance. Functional operation of the device and/or non-degradation at the *Absolute Maximum Ratings* or other conditions beyond those indicated in the *Recommended Operating Conditions* is not implied. The *Recommended Operating Conditions* indicate conditions at which the device is functional and the device should not be operated beyond such conditions. All voltages are measured with respect to the ground pin, unless otherwise specified.
- (2) The *Electrical Characteristics* tables list guaranteed specifications under the listed *Recommended Operating Conditions* except as otherwise modified or specified by the *Electrical Characteristics Conditions* and/or Notes. Typical specifications are estimations only and are not guaranteed.
- (3) Typical values represent most likely parametric norms at T<sub>A</sub> = +25°C, and at the *Recommended Operation Conditions* at the time of product characterization and are not guaranteed.
- (4) Datasheet min/max specification limits are guaranteed by test or statistical analysis.

Typical Performance Characteristics

Filter BW = 22kHz

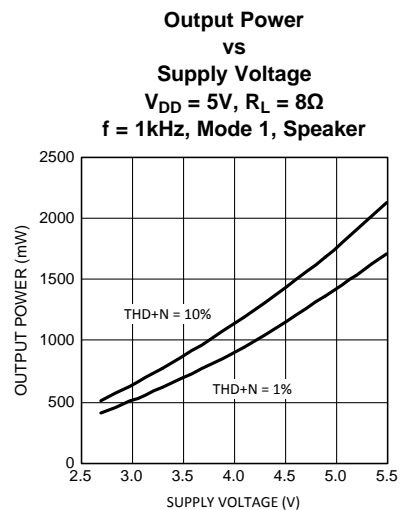
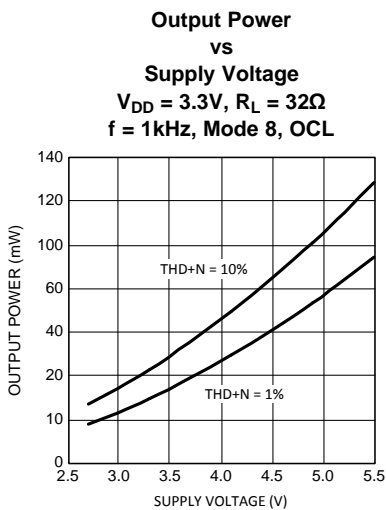
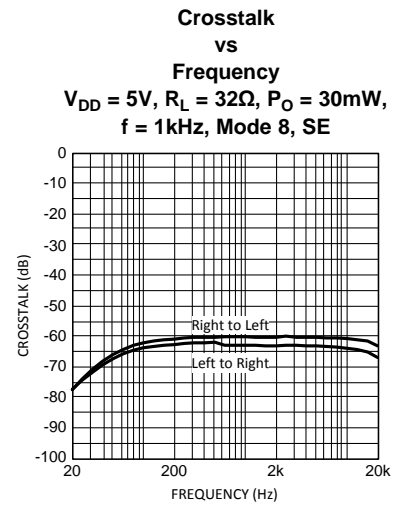
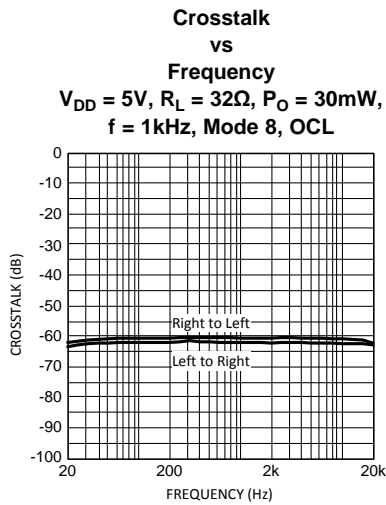
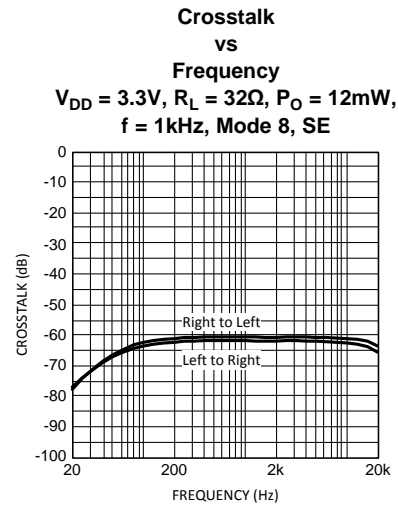
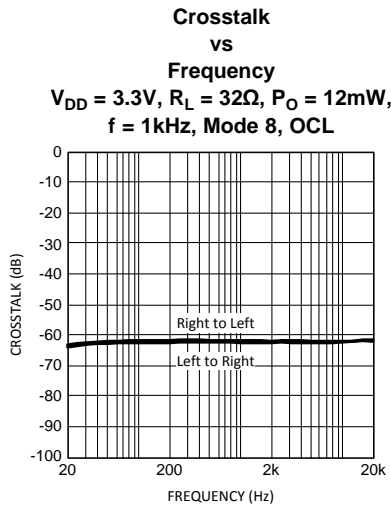

Typical Performance Characteristics (continued)

Filter BW = 22kHz

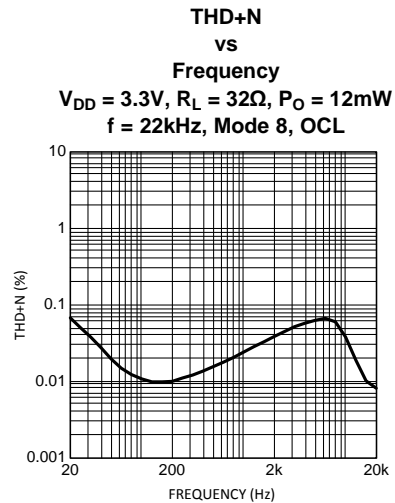
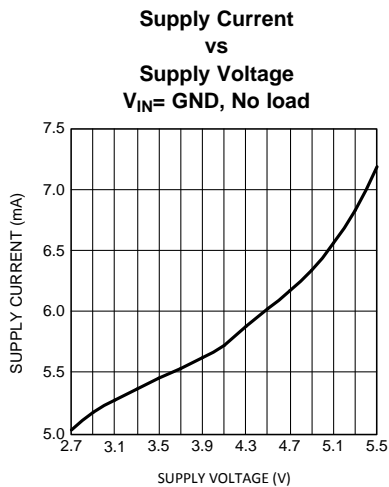
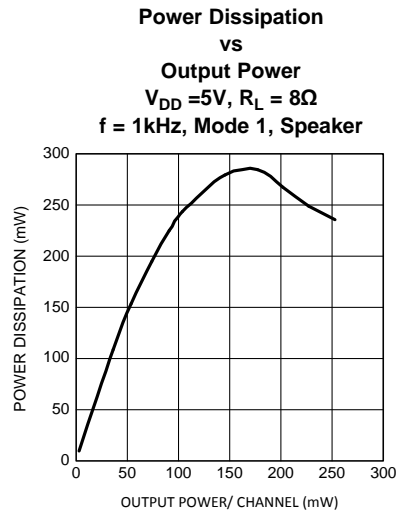
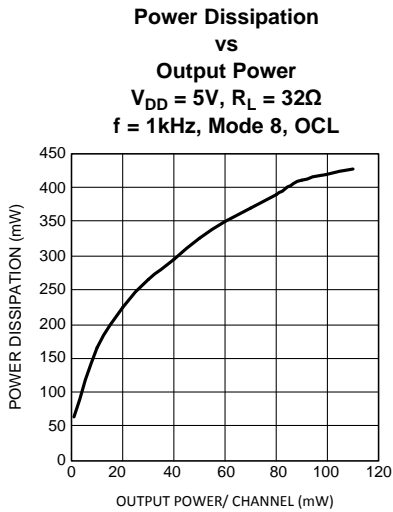
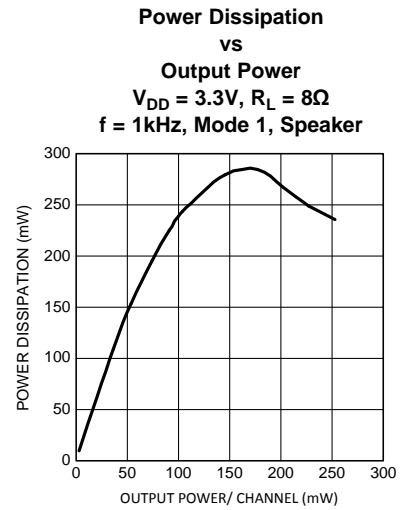
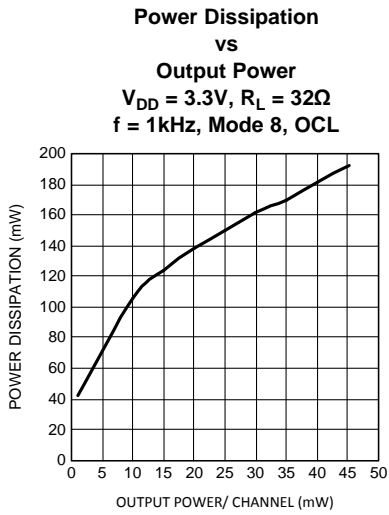

Typical Performance Characteristics (continued)

Filter BW = 22kHz

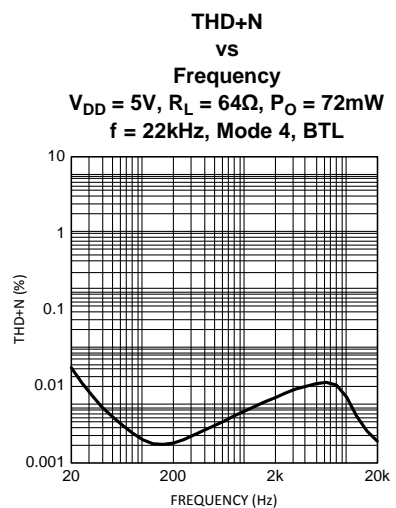
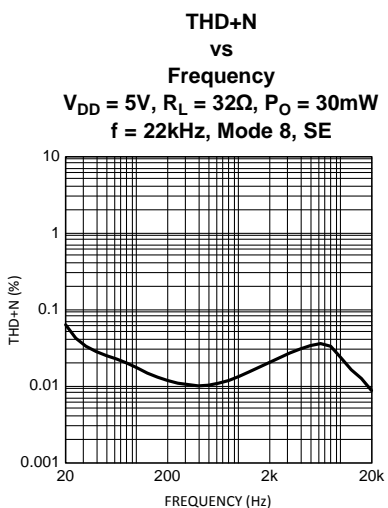
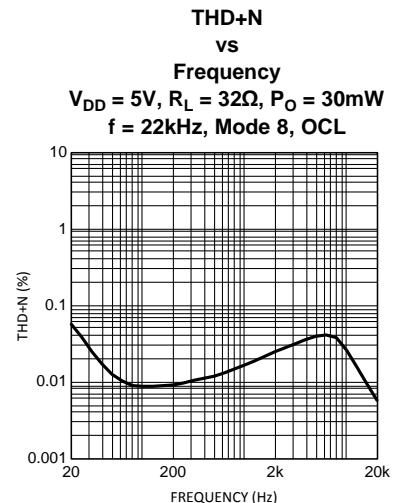
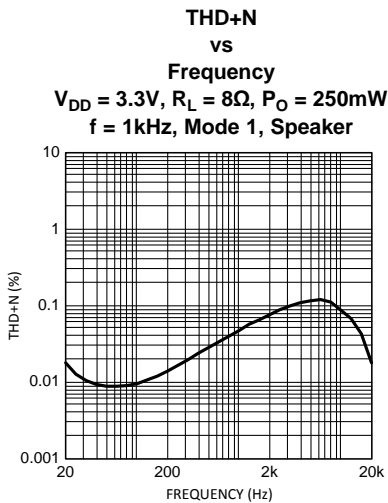
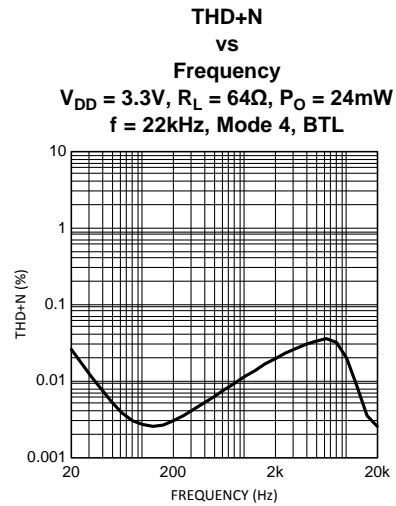
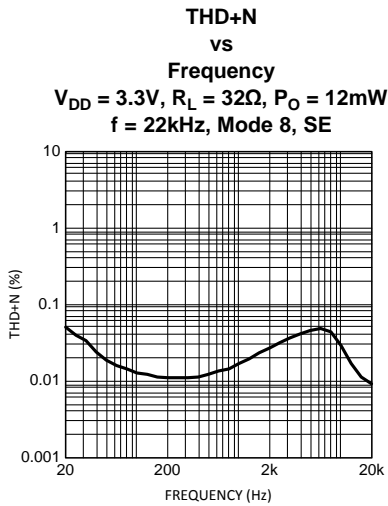

Typical Performance Characteristics (continued)

Filter BW = 22kHz

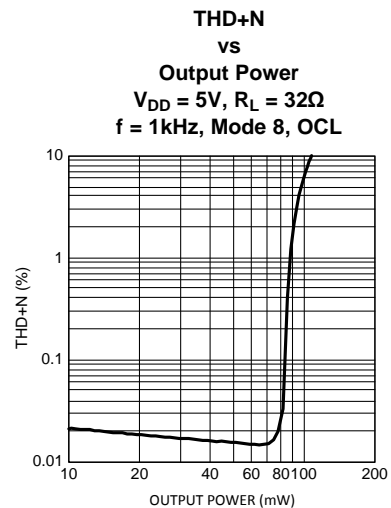
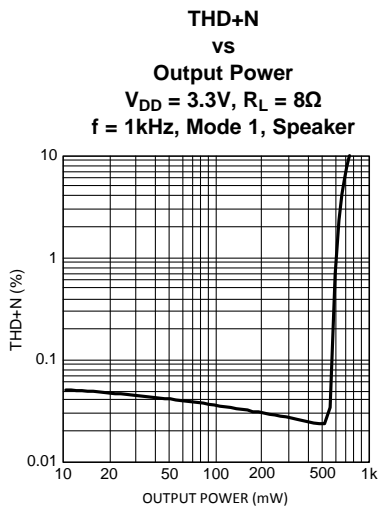
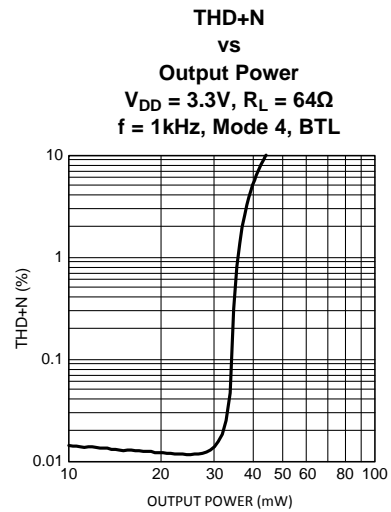
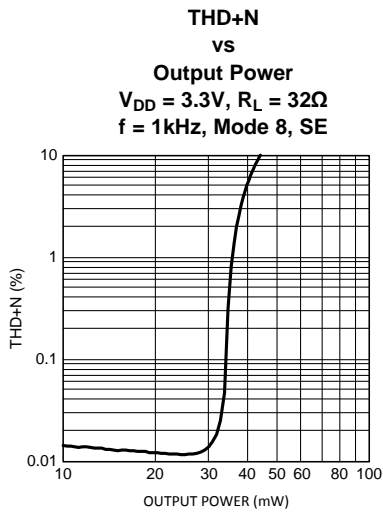
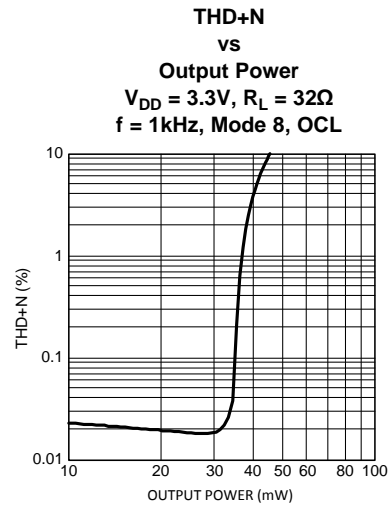
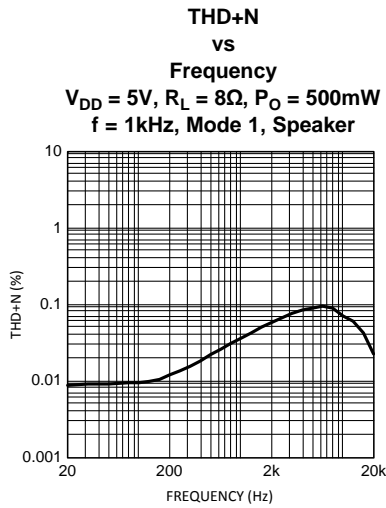

Typical Performance Characteristics (continued)

Filter BW = 22kHz

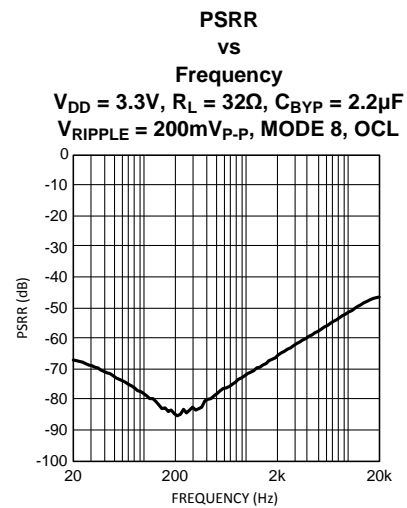
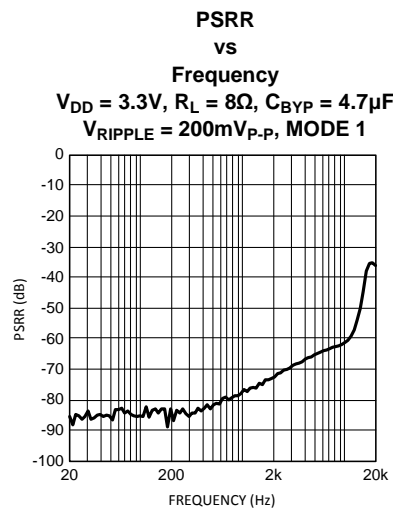
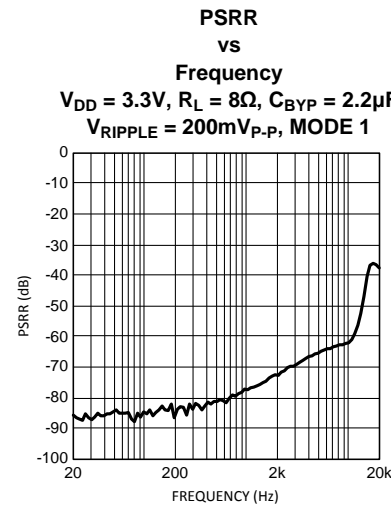
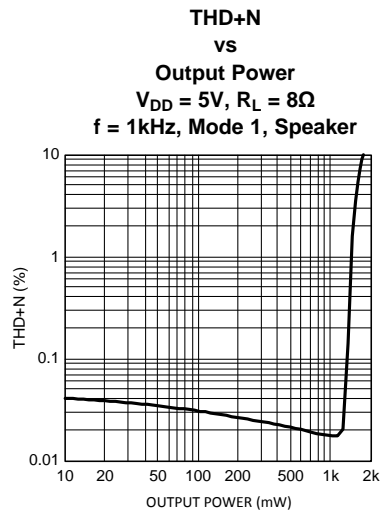
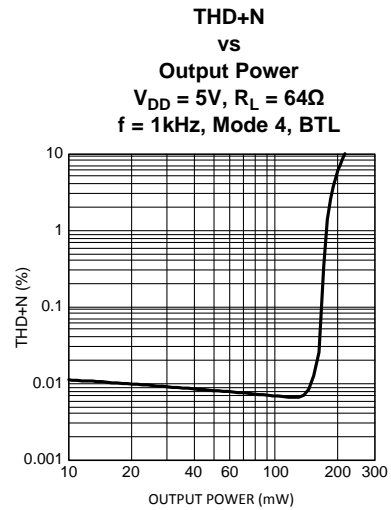
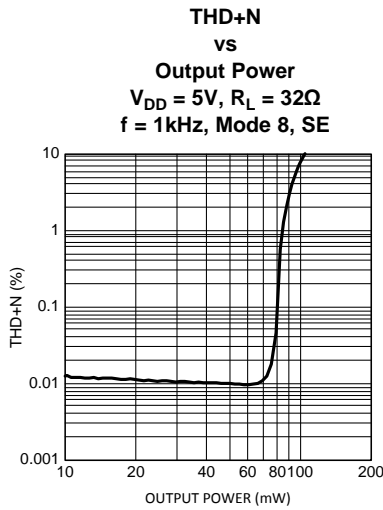

Typical Performance Characteristics (continued)

Filter BW = 22kHz

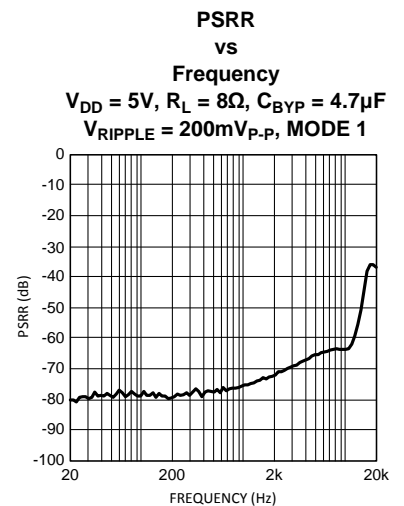
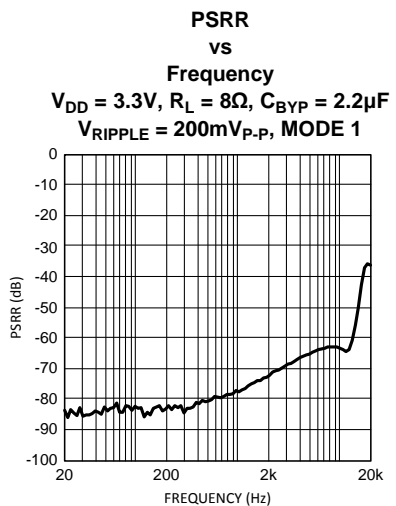
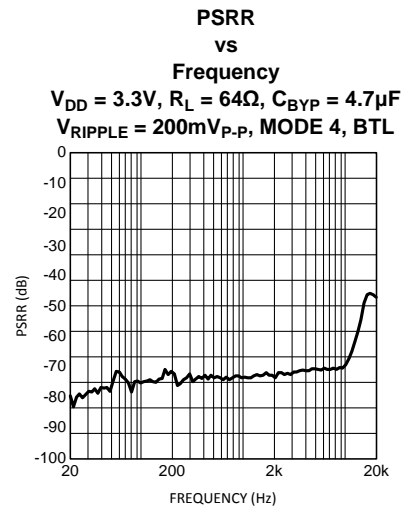
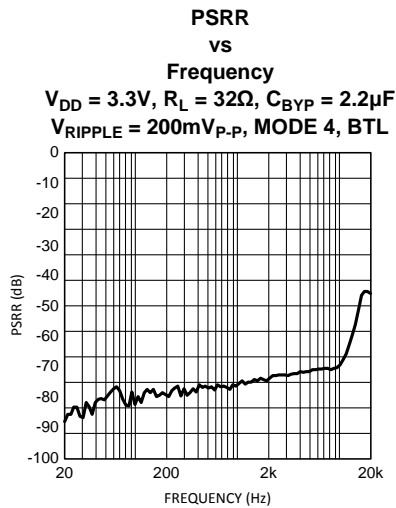
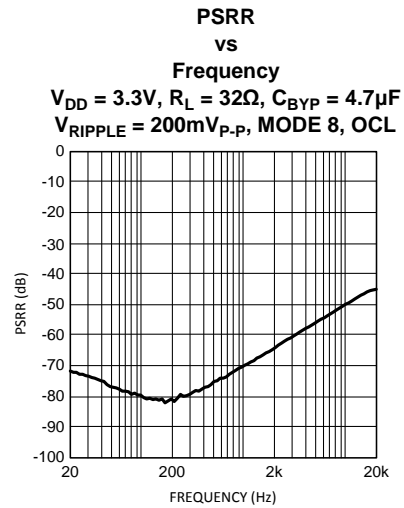
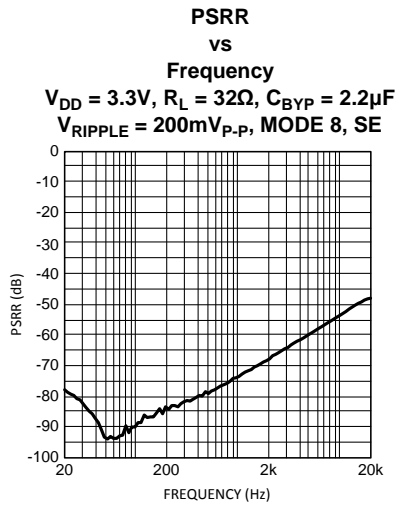

### Typical Performance Characteristics (continued)

Filter BW = 22kHz

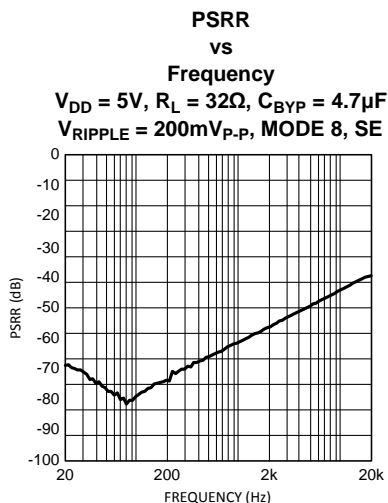
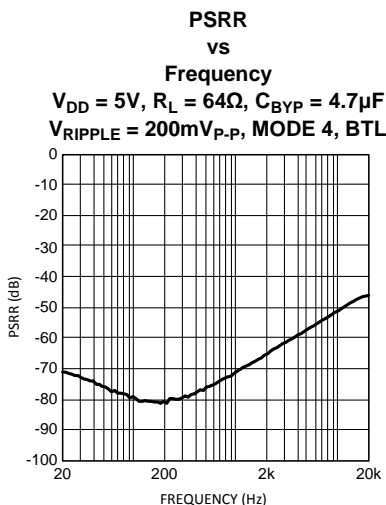
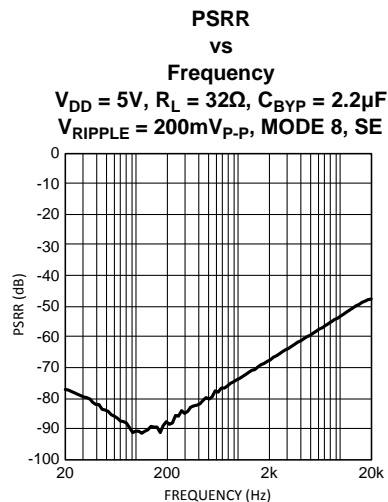
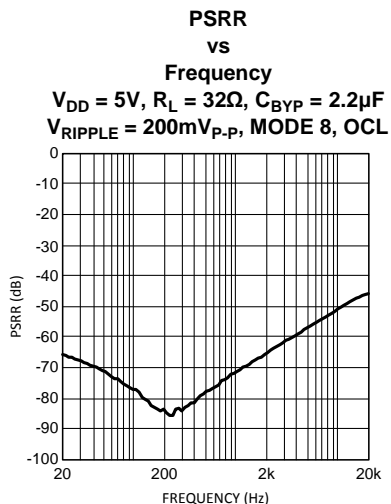

## Application Information

### I<sup>2</sup>C COMPATIBLE INTERFACE

The LM49120 is controlled through an I<sup>2</sup>C compatible serial interface that consists of a serial data line (SDA) and a serial clock (SCL). The clock line is uni-directional. The data line is bi-directional (open drain). The LM49120 and the master can communicate at clock rates up to 400kHz. Figure 5 shows the I<sup>2</sup>C interface timing diagram. Data on the SDA line must be stable during the HIGH period of SCL. The LM49120 is a transmit/receive slave-only device, reliant upon the master to generate the SCL signal. Each transmission sequence is framed by a START condition and a STOP condition (Figure 6). Each data word, device address and data, transmitted over the bus is 8 bits long and is always followed by an acknowledge pulse (Figure 7). The LM49120 device address is 1111100.

### I<sup>2</sup>C BUS FORMAT

The I<sup>2</sup>C bus format is shown in Figure 7. The START signal, the transition of SDA from HIGH to LOW while SCL is HIGH, is generated, alerting all devices on the bus that a device address is being written to the bus.

The 7-bit device address is written to the bus, most significant bit (MSB) first, followed by the  $R/\overline{W}$  bit.  $R/\overline{W} = 0$  indicates the master is writing to the slave device,  $R/\overline{W} = 1$  indicates the master wants to read data from the slave device. Set  $R/\overline{W} = 0$ ; the LM49120 is a WRITE-ONLY device and will not respond the  $R/\overline{W} = 1$ . The data is latched in on the rising edge of the clock. Each address bit must be stable while SCL is HIGH. After the last address bit is transmitted, the master device releases SDA, during which time, an acknowledge clock pulse is generated by the slave device. If the LM49120 receives the correct address, the device pulls the SDA line low, generating an acknowledge bit (ACK).

Once the master device registers the ACK bit, the 8-bit register data word is sent. Each data bit should be stable while SCL is HIGH. After the 8-bit register data word is sent, the LM49120 sends another ACK bit. Following the acknowledgement of the register data word, the master issues a STOP bit, allowing SDA to go high while SCL is high.

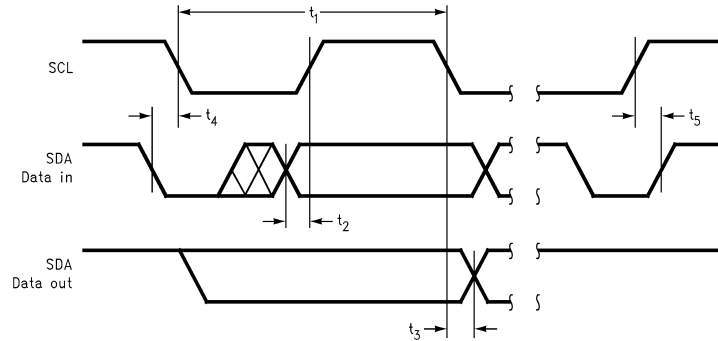

Figure 5. I<sup>2</sup>C Timing Diagram

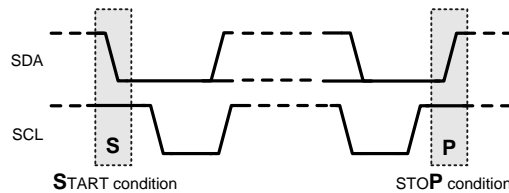

Figure 6. Start and Stop Diagram

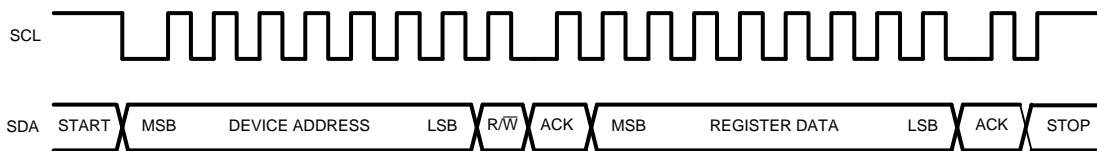

Figure 7. Example Write Sequence

Table 3. Device Address

	B7	B6	B5	B4	B3	B2	B1	B0 (R/ $\overline{W}$ )
Device Address	1	1	1	1	1	0	0	0

Table 4. Control Registers

	B7	B6	B5	B4	B3	B2	B1	B0
Shutdown Control	0	0	0	OCL/SE	HP/BTL	SD_I <sup>2</sup> CV <sub>DD</sub>	Turn_On_Time	PWR_On
Output Mode Control	0	1	0	0	MC3	MC2	MC1	MC0
Output Gain Control	1	0	0	0	LS_GAIN	HP_GAIN2	HP_GAIN1	HP_GAIN0
Mono Input Volume Control	1	0	1	MG4	MG3	MG2	MG1	MG0

**Table 4. Control Registers (continued)**

	B7	B6	B5	B4	B3	B2	B1	B0
Left Input Volume Control	1	1	0	LG4	LG3	LG2	LG1	LG0
Right Input Volume Control	1	1	1	RG4	RG3	RG2	RG1	RG0

**Table 5. Shutdown Control Register**

Bit	Name	Value	Description
B4	OSC/SE	0	Single-Ended headphone mode (Capacitively Coupled)
		1	Output Capacitor-less (OCL) headphone mode
B3	HP/BTL	0	Single-ended stereo headphone output mode
		1	Mono, BTL output mode.
B2	SD_I <sup>2</sup> CVDD	0	I <sup>2</sup> CV <sub>DD</sub> acts as an active low RESET input. If I <sup>2</sup> CV <sub>DD</sub> drops below 1.1V, the device is reset and the I2C registers are restored to their default state.
		1	Normal Operation. I <sup>2</sup> CV <sub>DD</sub> voltage does not reset the device
B1	TURN_ON_TIME	0	Fast turn on time (120ms)
		1	Normal turn on time (130ms)
B0	PWR_ON	0	Device Disabled
		1	Device Enabled

**Table 6. Output Mode Control (HP/BTL = 0)**

Output Mode Number	MC3	MC2	MC1	MC0	LS Output	HP R Output	HP L Output
0	0	0	0	0	SD	SD	SD
1	0	0	0	1	G <sub>M</sub> x M	Mute	Mute
2	0	0	1	0	2 x (G <sub>L</sub> x L + G <sub>R</sub> x R)	Mute	Mute
3	0	0	1	1	2 x (G <sub>L</sub> x L + G <sub>R</sub> x R) + G <sub>M</sub> x M	Mute	Mute
4	0	1	0	0	SD	G <sub>M</sub> x M/2	G <sub>M</sub> x M/2
5	0	1	0	1	G <sub>M</sub> x M	G <sub>M</sub> x M/2	G <sub>M</sub> x M/2
6	0	1	1	0	2 x (G <sub>L</sub> x L + G <sub>R</sub> x R)	G <sub>M</sub> x M/2	G <sub>M</sub> x M/2
7	0	1	1	1	2 x (G <sub>L</sub> x L + G <sub>R</sub> x R) + G <sub>M</sub> x M	G <sub>M</sub> x M/2	G <sub>M</sub> x M/2
8	1	0	0	0	SD	G <sub>R</sub> x R	G <sub>L</sub> x L
9	1	0	0	1	G <sub>M</sub> x M	G <sub>R</sub> x R	G <sub>L</sub> x L
10	1	0	1	0	2 x (G <sub>L</sub> x L + G <sub>R</sub> x R)	G <sub>R</sub> x R	G <sub>L</sub> x L
11	1	0	1	1	2 x (G <sub>L</sub> x L + G <sub>R</sub> x R) + G <sub>M</sub> x M	G <sub>R</sub> x R	G <sub>L</sub> x L
12	1	1	0	0	SD	G <sub>R</sub> x R + G <sub>M</sub> x M/2	G <sub>L</sub> x L + G <sub>M</sub> x M/2
13	1	1	0	1	G <sub>M</sub> x M	G <sub>R</sub> x R + G <sub>M</sub> x M/2	G <sub>L</sub> x L + G <sub>M</sub> x M/2
14	1	1	1	0	2 x (G <sub>L</sub> x L + G <sub>R</sub> x R)	G <sub>R</sub> x R + G <sub>M</sub> x M/2	G <sub>L</sub> x L + G <sub>M</sub> x M/2
15	1	1	1	1	2 x (G <sub>L</sub> x L + G <sub>R</sub> x R) + G <sub>M</sub> x M	G <sub>R</sub> x R + G <sub>M</sub> x M/2	G <sub>L</sub> x L + G <sub>M</sub> x M/2

**Table 7. Output Mode Control (HP/BTL = 1)**

Output Mode Number	MC3	MC2	MC1	MC0	LS Output	HP R Output	HP L Output
4	0	1	0	0	SD	G <sub>M</sub> x M <sup>+</sup> /2	G <sub>M</sub> x M <sup>+</sup> /2
5	0	1	0	1	G <sub>M</sub> x M	G <sub>M</sub> x M <sup>+</sup> /2	G <sub>M</sub> x M <sup>+</sup> /2

**Table 7. Output Mode Control (HP/BTL = 1) (continued)**

Output Mode Number	MC3	MC2	MC1	MC0	LS Output	HP R Output	HP L Output
6	0	1	1	0	$2 \times (G_L \times L + G_R \times R)$	$G_M \times M^{+}/2$	$G_M \times M^{+}/2$
7	0	1	1	1	$2 \times (G_L \times L + G_R \times R) + G_P \times P$	$G_M \times M^{+}/2$	$G_M \times M^{+}/2$
12	1	1	0	0	SD	$G_R \times R + G_M \times M^{+}/2$	$G_L \times L + G_M \times M^{+}/2$
13	1	1	0	1	$G_M \times M$	$G_R \times R + G_M \times M^{+}/2$	$G_L \times L + G_M \times M^{+}/2$
14	1	1	1	0	$2 \times (G_L \times L + G_R \times R)$	$G_R \times R + G_M \times M^{+}/2$	$G_L \times L + G_M \times M^{+}/2$
15	1	1	1	1	$2 \times (G_L \times L + G_R \times R) + G_M \times M$	$G_R \times R + G_M \times M^{+}/2$	$G_L \times L + G_M \times M^{+}/2$

**Table 8. Volume Control Table**

Volume Step	_G4	_G3	_G2	_G1	_G0	Gain (dB)
1	0	0	0	0	0	Mute
2	0	0	0	0	1	-46.50
3	0	0	0	1	0	-40.50
4	0	0	0	1	1	-34.50
5	0	0	1	0	0	-30.00
6	0	0	1	0	1	-27.00
7	0	0	1	1	0	-24.00
8	0	0	1	1	1	-21.00
9	0	1	0	0	0	-18.00
10	0	1	0	0	1	-15.00
11	0	1	0	1	0	-13.50
12	0	1	0	1	1	-12.00
13	0	1	1	0	0	-10.50
14	0	1	1	0	1	-9.00
15	0	1	1	1	0	-7.50
16	0	1	1	1	1	-6.00
17	1	0	0	0	0	-4.50
18	1	0	0	0	1	-3.00
19	1	0	0	1	0	-1.50
20	1	0	0	1	1	0.00
21	1	0	1	0	0	1.50
22	1	0	1	0	1	3.00
23	1	0	1	1	0	4.50
24	1	0	1	1	1	6.00
25	1	1	0	0	0	7.50
26	1	1	0	0	1	9.00
27	1	1	0	1	0	10.50
28	1	1	0	1	1	12.00
29	1	1	1	0	0	13.50
30	1	1	1	0	1	15.00
31	1	1	1	1	0	16.50
32	1	1	1	1	1	18.00

**Table 9. Output Gain Control (Headphone)**

HP_GAIN2	HP_GAIN1	HP_GAIN0	GAIN (dB)
0	0	0	0
0	0	1	-1.2
0	1	0	-2.5
0	1	1	-4.0
1	0	0	-6.0
1	0	1	-8.5
1	1	0	-12
1	1	1	-18

**Table 10. Output Gain Control (Loudspeaker)**

Bit	Value	Gain (dB) Differential Input	Gain (dB) Single-Ended Input
LS_GAIN	0	0	+6
	1	+6	+12

## BRIDGE CONFIGURATION EXPLAINED

The LM49120 loudspeaker amplifier is designed to drive a load differentially, a configuration commonly referred to as a bridge-tied load (BTL). The BTL configuration differs from the single-ended configuration, where one side of the load is connected to ground. A BTL amplifier offers advantages over a single-ended device. By driving the load differentially, the output voltage is doubled, compared to a single-ended amplifier under similar conditions. This doubling of the output voltage leads to a quadrupling of the output power, for example, the theoretical maximum output power for a single-ended amplifier driving 8Ω and operating from a 5V supply is 390mW, while the theoretical maximum output power for a BTL amplifier operating under the same conditions is 1.56W. Since the amplifier outputs are both biased about  $V_{DD}/2$ , there is no net DC voltage across the load, eliminating the DC blocking capacitors required by single-ended, single-supply amplifiers.

### Headphone Amplifier

The LM49120 headphone amplifier features two different operating modes, output capacitor-less (OCL) and single-ended (SE) capacitor coupled mode.

The OCL architecture eliminates the bulky, expensive output coupling capacitors required by traditional headphone amplifiers. In OCL mode, the LM49120 headphone section uses three amplifiers. Two amplifiers drive the headphones, while the third ( $V_{OC}$ ) is set to the internally generated bias voltage (typically  $V_{DD}/2$ ). The third amplifier is connected to the return terminal of the headphone jack (Figure 1). In this configuration, the signal side of the headphone is biased to  $V_{DD}/2$ , the return is biased to  $V_{DD}/2$ , thus there is no net DC voltage across the headphone, eliminating the need for an output coupling capacitor. Removing the output coupling capacitors from the headphone signal path reduces component count, reducing system cost and board space consumption, as well as improving low frequency performance.

In OCL mode, the headphone return sleeve is biased to  $V_{DD}/2$ . When driving headphones, the voltage on the return sleeve is not an issue. However, if the headphone output is used as a line out, the  $V_{DD}/2$  can conflict with the GND potential that the line-in would expect on the return sleeve. When the return of the headphone jack is connected to GND the  $V_{OC}$  amplifier of the LM49120 detects an output short circuit condition and is disabled, preventing damage to the LM49120, and allowing the headphone return to be biased at GND.

### Single-Ended, Capacitor Coupled Mode

In single-ended mode, the  $V_{OC}$  amplifier is disabled, and the headphone outputs are coupled to the jack through series capacitors, allowing the headphone return to be connected to GND (Figure 2). In SE mode, the LM49120 requires output coupling capacitors to block the DC component of the amplifier output, preventing DC current from flowing to the load. The output capacitor and speaker impedance form a high pass filter with a -3dB roll-off determined by:

$$f_{-3dB} = 1 / 2\pi R_L C_O \quad (\text{Hz}) \quad (1)$$

Where  $R_L$  is the headphone impedance, and  $C_O$  is the value of the output coupling capacitor. Choose  $C_O$  such that  $f_{-3dB}$  is well below the lowest frequency of interest. Setting  $f_{-3dB}$  too high results in poor low frequency performance. Select capacitor dielectric types with low ESR to minimize signal loss due to capacitor series resistance and maximize power transfer to the load.

### Headphone Amplifier BTL Mode

The LM49120 headphone amplifiers feature a BTL mode where the two headphone outputs,  $L_{OUT}$  and  $R_{OUT}$  are configured to drive a mono speaker differentially. In BTL mode, the amplifier accepts audio signals from either the differential MONO inputs, or the single-ended stereo inputs, and converts them to a mono BTL output. However, if the stereo inputs are 180° out of phase, no audio will be present at the amplifier outputs. Bit B3 (HP/BTL) in the Shutdown Control Register determines the headphone output mode. Set HP/BTL = 0 for stereo headphone mode, set HP/BTL = 1 for BTL mode.

### Input Mixer/Multiplexer

The LM49120 includes a comprehensive mixer multiplexer controlled through the I<sup>2</sup>C interface. The mixer/multiplexer allows any input combination to appear on any output of the LM49120. Multiple input paths can be selected simultaneously. Under these conditions, the selected inputs are mixed together and output on the selected channel. Tables 4 and 5 show how the input signals are mixed together for each possible input selection.

### Audio Amplifier Gain Setting

Each channel of the LM49120 has two separate gain stages. Each input stage features a 32-step volume control with a range of -46dB to +18dB (Table 6). The loudspeaker output stage has two additional gain settings: 0dB and +6dB (Table 8) when the differential MONO input is selected, and +6dB and +12dB when the single-ended stereo inputs are selected. The headphone gain is not affected by the input mode. Each headphone output stage has 8 gain settings (Table 7). This allows for a maximum separation of 22dB between the speaker and headphone outputs when both are active.

Calculate the total gain of the given signal path as follows:

$$A_{VOL} + A_{VOS} = A_{VTOTAL} \quad (\text{dB}) \quad (2)$$

Where  $A_{VOL}$  is the volume control level,  $A_{VOS}$  is the output stage gain setting, and  $A_{VTOTAL}$  is the total gain for the signal path.

## POWER DISSIPATION

Power dissipation is a major concern when designing a successful single-ended or bridged amplifier.

A direct consequence of the increased power delivered to the load by a bridge amplifier is higher internal power dissipation. The LM49120 has a pair of bridged-tied amplifiers driving a handsfree speaker, MONO. The maximum internal power dissipation operating in the bridge mode is twice that of a single-ended amplifier. From Equation (2), assuming a 5V power supply and an 8Ω load, the maximum MONO power dissipation is 633mW.

$$P_{DMAX-SPKROUT} = 4(V_{DD})^2 / (2\pi^2 R_L): \text{ Bridge Mode} \quad (3)$$

The LM49120 also has a pair of single-ended amplifiers driving stereo headphones,  $R_{OUT}$  and  $L_{OUT}$ . The maximum internal power dissipation for  $R_{OUT}$  and  $L_{OUT}$  is given by equation (3) and (4). From Equations (3) and (4), assuming a 5V power supply and a 32Ω load, the maximum power dissipation for  $L_{OUT}$  and  $R_{OUT}$  is 40mW, or 80mW total.

$$P_{DMAX-LOUT} = (V_{DD})^2 / (2\pi^2 R_L): \text{ Single-ended Mode} \quad (4)$$

$$P_{\text{DMAX-ROUT}} = (V_{\text{DD}})^2 / (2\pi^2 R_L): \text{Single-ended Mode} \quad (5)$$

The maximum internal power dissipation of the LM49120 occurs when all three amplifiers pairs are simultaneously on; and is given by Equation (5).

$$P_{\text{DMAX-TOTAL}} = P_{\text{DMAX-SPKROUT}} + P_{\text{DMAX-LOUT}} + P_{\text{DMAX-ROUT}} \quad (6)$$

The maximum power dissipation point given by Equation (5) must not exceed the power dissipation given by Equation (6):

$$P_{\text{DMAX}} = (T_{\text{JMAX}} - T_A) / \theta_{\text{JA}} \quad (7)$$

The LM49120's  $T_{\text{JMAX}} = 150^\circ\text{C}$ . In the SQ package, the LM49120's  $\theta_{\text{JA}}$  is  $46^\circ\text{C/W}$ . At any given ambient temperature  $T_A$ , use Equation (6) to find the maximum internal power dissipation supported by the IC packaging. Rearranging Equation (6) and substituting  $P_{\text{DMAX-TOTAL}}$  for  $P_{\text{DMAX}}$  results in Equation (7). This equation gives the maximum ambient temperature that still allows maximum stereo power dissipation without violating the LM49120's maximum junction temperature.

$$T_A = T_{\text{JMAX}} - P_{\text{DMAX-TOTAL}} \theta_{\text{JA}} \quad (8)$$

For a typical application with a 5V power supply and an  $8\Omega$  load, the maximum ambient temperature that allows maximum mono power dissipation without exceeding the maximum junction temperature is approximately  $121^\circ\text{C}$  for the SQ package.

$$T_{\text{JMAX}} = P_{\text{DMAX-TOTAL}} \theta_{\text{JA}} + T_A \quad (9)$$

Equation (8) gives the maximum junction temperature  $T_{\text{JMAX}}$ . If the result violates the LM49120's  $150^\circ\text{C}$ , reduce the maximum junction temperature by reducing the power supply voltage or increasing the load resistance. Further allowance should be made for increased ambient temperatures.

The above examples assume that a device is a surface mount part operating around the maximum power dissipation point. Since internal power dissipation is a function of output power, higher ambient temperatures are allowed as output power or duty cycle decreases. If the result of Equation (5) is greater than that of Equation (6), then decrease the supply voltage, increase the load impedance, or reduce the ambient temperature. If these measures are insufficient, a heat sink can be added to reduce  $\theta_{\text{JA}}$ . The heat sink can be created using additional copper area around the package, with connections to the ground pin(s), supply pin and amplifier output pins. External, solder attached SMT heatsinks such as the Thermalloy 7106D can also improve power dissipation. When adding a heat sink, the  $\theta_{\text{JA}}$  is the sum of  $\theta_{\text{JC}}$ ,  $\theta_{\text{CS}}$ , and  $\theta_{\text{SA}}$ . ( $\theta_{\text{JC}}$  is the junction-to-case thermal impedance,  $\theta_{\text{CS}}$  is the case-to-sink thermal impedance, and  $\theta_{\text{SA}}$  is the sink-to-ambient thermal impedance). Refer to the Typical Performance Characteristics curves for power dissipation information at lower output power levels.

## PROPER SELECTION OF EXTERNAL COMPONENTS

### Power Supply Bypassing/Filtering

Proper power supply bypassing is critical for low noise performance and high PSRR. Place the supply bypass capacitors as close to the device as possible. Place a  $1\mu\text{F}$  ceramic capacitor from  $V_{\text{DD}}$  to GND. Additional bulk capacitance may be added as required.

### Input Capacitor Selection

Input capacitors may be required for some applications, or when the audio source is single-ended. Input capacitors block the DC component of the audio signal, eliminating any conflict between the DC component of the audio source and the bias voltage of the LM49120. The input capacitors create a high-pass filter with the input resistors  $R_{\text{IN}}$ . The -3dB point of the high pass filter is found using Equation (3) below.

$$f = 1 / (2\pi R_{\text{IN}} C_{\text{IN}}) \quad (\text{Hz}) \quad (10)$$

Where the value of  $R_{IN}$  is given in the Electrical Characteristics Table.

High pass filtering the audio signal helps protect the speakers. When the LM49120 is using a single-ended source, power supply noise on the ground is seen as an input signal. Setting the high-pass filter point above the power supply noise frequencies, 217Hz in a GSM phone, for example, filters out the noise such that it is not amplified and heard on the output. Capacitors with a tolerance of 10% or better are recommended for impedance matching and improved CMRR and PSRR.

### ***Bias Capacitor Selection***

The LM49120 internally generates a  $V_{DD}/2$  common-mode bias voltage. The BIAS capacitor  $C_{BIAS}$ , improves PSRR and THD+N by reducing noise at the BIAS node. Use a 2.2 $\mu$ F ceramic placed as close to the device as possible.

### **PCB LAYOUT GUIDELINES**

Minimize trace impedance of the power, ground and all output traces for optimum performance. Voltage loss due to trace resistance between the LM49120 and the load results in decreased output power and efficiency. Trace resistance between the power supply and ground has the same effect as a poorly regulated supply, increased ripple and reduced peak output power. Use wide traces for power supply inputs and amplifier outputs to minimize losses due to trace resistance, as well as route heat away from the device. Proper grounding improves audio performance, minimizes crosstalk between channels and prevents digital noise from interfering with the audio signal. Use of power and ground planes is recommended.

Place all digital components and route digital signal traces as far as possible from analog components and traces. Do not run digital and analog traces in parallel on the same PCB layer. If digital and analog signal lines must cross either over or under each other, ensure that they cross in a perpendicular fashion.

### **Revision History**

<b>Rev</b>	<b>Date</b>	<b>Description</b>
1.0	06/26/08	Initial release.
1.01	07/15/08	Edited the Ordering Information table.

**PACKAGING INFORMATION**

Orderable Device	Status (1)	Package Type	Package Drawing	Pins	Package Qty	Eco Plan (2)	Lead/Ball Finish	MSL Peak Temp (3)	Samples (Requires Login)
LM49120TL/NOPB	ACTIVE	DSBGA	YZR	16	250	Green (RoHS & no Sb/Br)	SNAGCU	Level-1-260C-UNLIM	
LM49120TLX/NOPB	ACTIVE	DSBGA	YZR	16	3000	Green (RoHS & no Sb/Br)	SNAGCU	Level-1-260C-UNLIM	

(1) The marketing status values are defined as follows:

**ACTIVE:** Product device recommended for new designs.

**LIFEBUY:** TI has announced that the device will be discontinued, and a lifetime-buy period is in effect.

**NRND:** Not recommended for new designs. Device is in production to support existing customers, but TI does not recommend using this part in a new design.

**PREVIEW:** Device has been announced but is not in production. Samples may or may not be available.

**OBSELETE:** TI has discontinued the production of the device.

(2) Eco Plan - The planned eco-friendly classification: Pb-Free (RoHS), Pb-Free (RoHS Exempt), or Green (RoHS & no Sb/Br) - please check <http://www.ti.com/productcontent> for the latest availability information and additional product content details.

**TBD:** The Pb-Free/Green conversion plan has not been defined.

**Pb-Free (RoHS):** TI's terms "Lead-Free" or "Pb-Free" mean semiconductor products that are compatible with the current RoHS requirements for all 6 substances, including the requirement that lead not exceed 0.1% by weight in homogeneous materials. Where designed to be soldered at high temperatures, TI Pb-Free products are suitable for use in specified lead-free processes.

**Pb-Free (RoHS Exempt):** This component has a RoHS exemption for either 1) lead-based flip-chip solder bumps used between the die and package, or 2) lead-based die adhesive used between the die and leadframe. The component is otherwise considered Pb-Free (RoHS compatible) as defined above.

**Green (RoHS & no Sb/Br):** TI defines "Green" to mean Pb-Free (RoHS compatible), and free of Bromine (Br) and Antimony (Sb) based flame retardants (Br or Sb do not exceed 0.1% by weight in homogeneous material)

(3) MSL, Peak Temp. -- The Moisture Sensitivity Level rating according to the JEDEC industry standard classifications, and peak solder temperature.

**Important Information and Disclaimer:** The information provided on this page represents TI's knowledge and belief as of the date that it is provided. TI bases its knowledge and belief on information provided by third parties, and makes no representation or warranty as to the accuracy of such information. Efforts are underway to better integrate information from third parties. TI has taken and continues to take reasonable steps to provide representative and accurate information but may not have conducted destructive testing or chemical analysis on incoming materials and chemicals. TI and TI suppliers consider certain information to be proprietary, and thus CAS numbers and other limited information may not be available for release.

In no event shall TI's liability arising out of such information exceed the total purchase price of the TI part(s) at issue in this document sold by TI to Customer on an annual basis.

## TAPE AND REEL INFORMATION



### QUADRANT ASSIGNMENTS FOR PIN 1 ORIENTATION IN TAPE



\*All dimensions are nominal

Device	Package Type	Package Drawing	Pins	SPQ	Reel Diameter (mm)	Reel Width W1 (mm)	A0 (mm)	B0 (mm)	K0 (mm)	P1 (mm)	W (mm)	Pin1 Quadrant
LM49120TL/NOPB	DSBGA	YZR	16	250	178.0	8.4	2.08	2.08	0.76	4.0	8.0	Q1
LM49120TLX/NOPB	DSBGA	YZR	16	3000	178.0	8.4	2.08	2.08	0.76	4.0	8.0	Q1

**TAPE AND REEL BOX DIMENSIONS**



\*All dimensions are nominal

Device	Package Type	Package Drawing	Pins	SPQ	Length (mm)	Width (mm)	Height (mm)
LM49120TL/NOPB	DSBGA	YZR	16	250	203.0	190.0	41.0
LM49120TLX/NOPB	DSBGA	YZR	16	3000	206.0	191.0	90.0

YZR0016

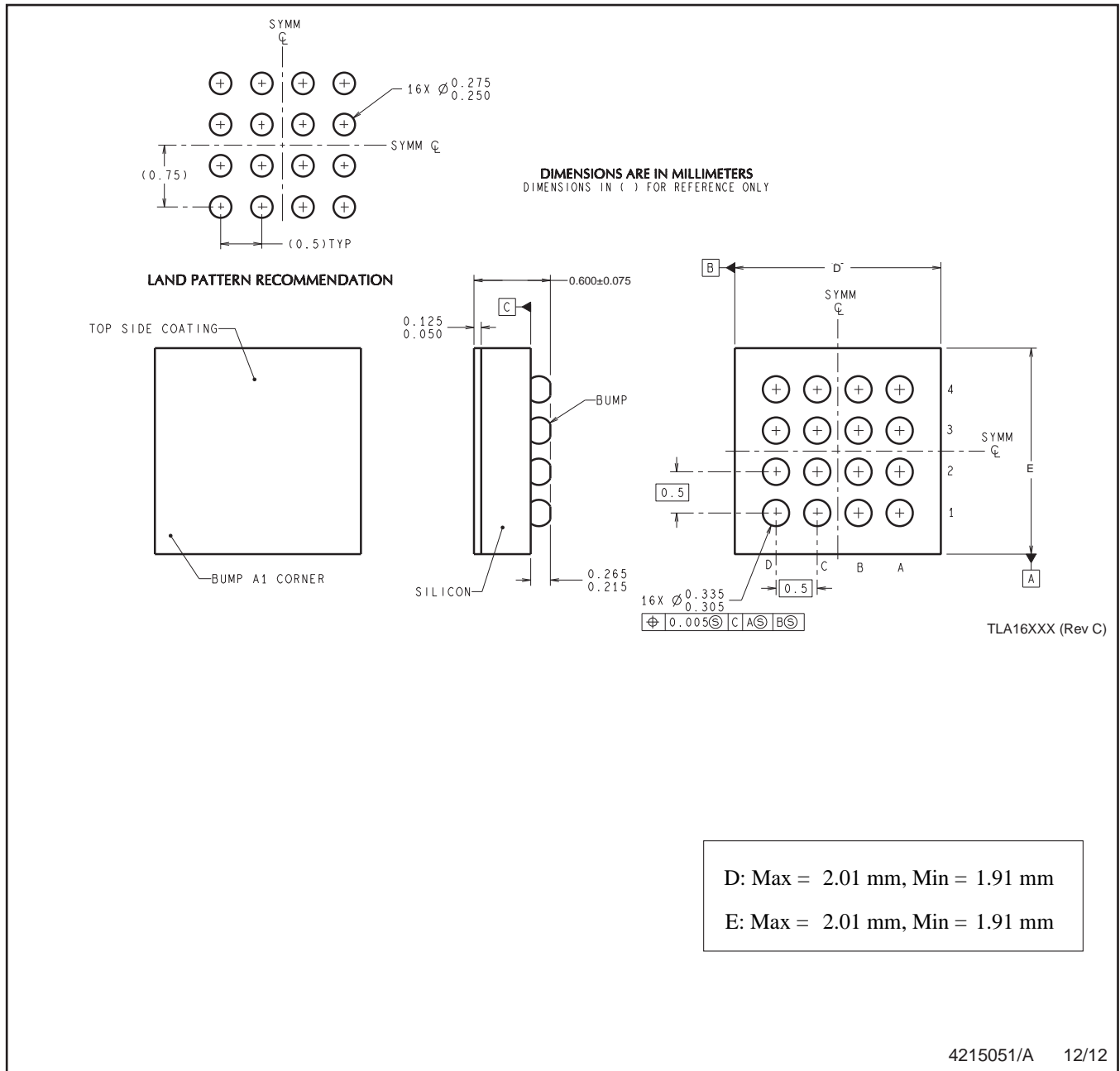

NOTES: A. All linear dimensions are in millimeters. Dimensioning and tolerancing per ASME Y14.5M-1994.  
B. This drawing is subject to change without notice.

## IMPORTANT NOTICE

Texas Instruments Incorporated and its subsidiaries (TI) reserve the right to make corrections, enhancements, improvements and other changes to its semiconductor products and services per JESD46, latest issue, and to discontinue any product or service per JESD48, latest issue. Buyers should obtain the latest relevant information before placing orders and should verify that such information is current and complete. All semiconductor products (also referred to herein as "components") are sold subject to TI's terms and conditions of sale supplied at the time of order acknowledgment.

TI warrants performance of its components to the specifications applicable at the time of sale, in accordance with the warranty in TI's terms and conditions of sale of semiconductor products. Testing and other quality control techniques are used to the extent TI deems necessary to support this warranty. Except where mandated by applicable law, testing of all parameters of each component is not necessarily performed.

TI assumes no liability for applications assistance or the design of Buyers' products. Buyers are responsible for their products and applications using TI components. To minimize the risks associated with Buyers' products and applications, Buyers should provide adequate design and operating safeguards.

TI does not warrant or represent that any license, either express or implied, is granted under any patent right, copyright, mask work right, or other intellectual property right relating to any combination, machine, or process in which TI components or services are used. Information published by TI regarding third-party products or services does not constitute a license to use such products or services or a warranty or endorsement thereof. Use of such information may require a license from a third party under the patents or other intellectual property of the third party, or a license from TI under the patents or other intellectual property of TI.

Reproduction of significant portions of TI information in TI data books or data sheets is permissible only if reproduction is without alteration and is accompanied by all associated warranties, conditions, limitations, and notices. TI is not responsible or liable for such altered documentation. Information of third parties may be subject to additional restrictions.

Resale of TI components or services with statements different from or beyond the parameters stated by TI for that component or service voids all express and any implied warranties for the associated TI component or service and is an unfair and deceptive business practice. TI is not responsible or liable for any such statements.

Buyer acknowledges and agrees that it is solely responsible for compliance with all legal, regulatory and safety-related requirements concerning its products, and any use of TI components in its applications, notwithstanding any applications-related information or support that may be provided by TI. Buyer represents and agrees that it has all the necessary expertise to create and implement safeguards which anticipate dangerous consequences of failures, monitor failures and their consequences, lessen the likelihood of failures that might cause harm and take appropriate remedial actions. Buyer will fully indemnify TI and its representatives against any damages arising out of the use of any TI components in safety-critical applications.

In some cases, TI components may be promoted specifically to facilitate safety-related applications. With such components, TI's goal is to help enable customers to design and create their own end-product solutions that meet applicable functional safety standards and requirements. Nonetheless, such components are subject to these terms.

No TI components are authorized for use in FDA Class III (or similar life-critical medical equipment) unless authorized officers of the parties have executed a special agreement specifically governing such use.

Only those TI components which TI has specifically designated as military grade or "enhanced plastic" are designed and intended for use in military/aerospace applications or environments. Buyer acknowledges and agrees that any military or aerospace use of TI components which have **not** been so designated is solely at the Buyer's risk, and that Buyer is solely responsible for compliance with all legal and regulatory requirements in connection with such use.

TI has specifically designated certain components as meeting ISO/TS16949 requirements, mainly for automotive use. In any case of use of non-designated products, TI will not be responsible for any failure to meet ISO/TS16949.

### Products

Audio	<a href="http://www.ti.com/audio">www.ti.com/audio</a>
Amplifiers	<a href="http://amplifier.ti.com">amplifier.ti.com</a>
Data Converters	<a href="http://dataconverter.ti.com">dataconverter.ti.com</a>
DLP® Products	<a href="http://www.dlp.com">www.dlp.com</a>
DSP	<a href="http://dsp.ti.com">dsp.ti.com</a>
Clocks and Timers	<a href="http://www.ti.com/clocks">www.ti.com/clocks</a>
Interface	<a href="http://interface.ti.com">interface.ti.com</a>
Logic	<a href="http://logic.ti.com">logic.ti.com</a>
Power Mgmt	<a href="http://power.ti.com">power.ti.com</a>
Microcontrollers	<a href="http://microcontroller.ti.com">microcontroller.ti.com</a>
RFID	<a href="http://www.ti-rfid.com">www.ti-rfid.com</a>
OMAP Applications Processors	<a href="http://www.ti.com/omap">www.ti.com/omap</a>
Wireless Connectivity	<a href="http://www.ti.com/wirelessconnectivity">www.ti.com/wirelessconnectivity</a>

### Applications

Automotive and Transportation	<a href="http://www.ti.com/automotive">www.ti.com/automotive</a>
Communications and Telecom	<a href="http://www.ti.com/communications">www.ti.com/communications</a>
Computers and Peripherals	<a href="http://www.ti.com/computers">www.ti.com/computers</a>
Consumer Electronics	<a href="http://www.ti.com/consumer-apps">www.ti.com/consumer-apps</a>
Energy and Lighting	<a href="http://www.ti.com/energy">www.ti.com/energy</a>
Industrial	<a href="http://www.ti.com/industrial">www.ti.com/industrial</a>
Medical	<a href="http://www.ti.com/medical">www.ti.com/medical</a>
Security	<a href="http://www.ti.com/security">www.ti.com/security</a>
Space, Avionics and Defense	<a href="http://www.ti.com/space-avionics-defense">www.ti.com/space-avionics-defense</a>
Video and Imaging	<a href="http://www.ti.com/video">www.ti.com/video</a>

### TI E2E Community

[e2e.ti.com](http://e2e.ti.com)