

LM4870 Boomer® Audio Power Amplifier Series

1.1W Audio Power Amplifier with Shutdown Mode

General Description

The LM4870 is a bridge-connected audio power amplifier capable of delivering 1.1W of continuous average power to an 8Ω load with less than 0.5% THD+N over the audio spectrum from a 5V power supply.

Boomer audio power amplifiers were designed specifically to provide high quality output power with a minimal number of external components. Since the LM4870 does not require output coupling capacitors, bootstrap capacitors or snubber networks, it is optimally suited for low-power portable systems.

The LM4870 features an externally controlled, low-power consumption shutdown mode, as well as an internal thermal shutdown protection mechanism. It also includes two headphone control inputs and a headphone sense output for external monitoring. The LM4870 is unity-gain stable and the gain is set using external resistors.

Key Specifications

- THD+N at 1W into 8Ω 0.5% (max)
- Output power into 8Ω at 1kHz at 10% THD+N 1.5W (typ)
- Shutdown Current 0.6μA (typ)

Features

- No output coupling capacitors, bootstrap capacitors, or snubber circuits are necessary
- Small Outline (SOIC) power packaging
- Unity-gain stable
- External gain configuration capability

Applications

- Personal computers
- Desktop computers
- Low voltage audio system

Typical Application

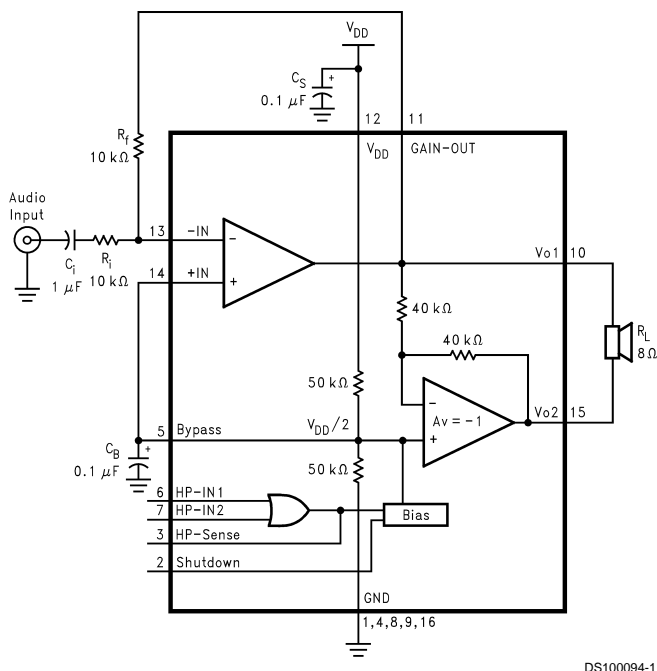
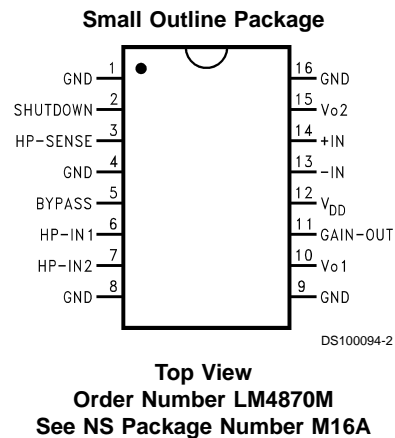

FIGURE 1. Typical Audio Amplifier Application Circuit

Connection Diagram



Boomer® is a registered trademark of National Semiconductor Corporation.

Absolute Maximum Ratings (Note 2)

If Military/Aerospace specified devices are required, please contact the National Semiconductor Sales Office/Distributors for availability and specifications.

Supply Voltage	6.0V
Storage Temperature	-65°C to +150°C
Input Voltage	-0.3V to $V_{DD} + 0.3V$
Power Dissipation	Internally limited
ESD Susceptibility (Note 4)	3000V
ESD Susceptibility (Note 5)	250V
Junction Temperature	150°C
Soldering Information	
Small Outline Package	
Vapor Phase (60 sec.)	215°C

Infrared (15 sec.) 220°C

Thermal Resistance

 $\phi_{JC}(typ)$ 35°C/W $\phi_{JA}(typ)$ 100°C/W

See AN-450 "Surface Mounting and their Effects on Product Reliability" for other methods of soldering surface mount devices.

Operating Ratings

Temperature Range

 $T_{MIN} \leq T_A \leq T_{MAX}$ -20°C $\leq T_A \leq$ +85°C

Supply Voltage

 $2.0V \leq V_{DD} \leq 5.5V$ **Electrical Characteristics**

(Notes 1, 2) The following specifications apply for $V_{DD} = 5V$, $R_L = 8\Omega$ unless otherwise specified. Limits apply for $T_A = 25^\circ C$.

Symbol	Parameter	Conditions	LM4870		Units (Limits)
			Typical (Note 6)	Limit (Note 7)	
V_{DD}	Supply Voltage			2.0 5.5	V (min) V (max)
I_{DD}	Quiescent Power Supply Current	$V_O = 0V$, $I_O = 0A$	7.0	15.0	mA (max)
I_{SD}	Shutdown Current	$V_{pin2} = V_{DD}$	0.4		μA
V_{OS}	Output Offset Voltage	$V_{IN} = 0V$	10	50.0	mV (max)
P_O	Output Power	THD+N = 0.5% (max); $f = 1$ kHz	1.1	1.0	W (min)
THD+N	Total Harmonic Distortion + Noise	$P_O = 1$ Wrms; 20 Hz $\leq f \leq 20$ kHz	0.25		%
PSRR	Power Supply Rejection Ratio	$V_{DD} = 4.9V$ to $5.1V$	60		dB
V_{od}	Output Dropout Voltage	$V_{IN} = 0V$ to $5V$	0.6	1.0	V (max)
V_{IH}	HP-IN High Input Voltage	HP-SENSE = $0V$ to $4V$	2.5		V
V_{IL}	HP-IN Low Input Voltage	HP-SENSE = $4V$ to $0V$	2.5		V
V_{OH}	HP-SENSE High Output Voltage	$I_O = 500 \mu A$	2.8	2.5	V (min)
V_{OL}	HP-SENSE Low Output Voltage	$I_O = -500 \mu A$	0.2	0.8	V (max)

Note 1: All voltages are measured with respect to the ground pins, unless otherwise specified.

Note 2: Absolute Maximum Ratings indicate limits beyond which damage to the device may occur. Operating Ratings indicate conditions for which the device is functional, but do not guarantee specific performance limits. Electrical Characteristics state DC and AC electrical specifications under particular test conditions which guarantee specific performance limits. This assumes that the device is within the Operating Ratings. Specifications are not guaranteed for parameters where no limit is given, however, the typical value is a good indication of device performance.

Note 3: The maximum power dissipation must be derated at elevated temperatures and is dictated by T_{JMAX} , θ_{JA} , and the ambient temperature T_A . The maximum allowable power dissipation is $P_{DMAX} = (T_{JMAX} - T_A)/\theta_{JA}$ or the number given in the Absolute Maximum Ratings, whichever is lower. For the LM4870, $T_{JMAX} = +150^\circ C$, and the typical junction-to-ambient thermal resistance, when board mounted, is $100^\circ C/W$.

Note 4: Human body model, 100 pF discharged through a 1.5 k Ω resistor.

Note 5: Machine Model, 200 pF–240 pF discharged through all pins.

Note 6: Typicals are measured at $25^\circ C$ and represent the parametric norm.

Note 7: Limits are guaranteed to National's AOQL (Average Outgoing Quality Level).

External Components Description (Figure 1)

Components	Functional Description
1. R_i	Inverting input resistance which sets the closed-loop gain in conjunction with R_f . This resistor also forms a high pass filter with C_i at $f_C = 1/(2\pi R_i C_i)$.
2. C_i	Input coupling capacitor which blocks DC voltage at the amplifier's input terminals. Also creates a highpass filter with R_i at $f_C = 1/(2\pi R_i C_i)$.
3. R_f	Feedback resistance which sets closed-loop gain in conjunction with R_i .
4. C_S	Supply bypass capacitor which provides power supply filtering. Refer to the Application Information section for proper placement and selection of supply bypass capacitor.
5. C_B	Bypass pin capacitor which provides half supply filtering. Refer to Application Information section for proper placement and selection of bypass capacitor.

Typical Performance Characteristics

THD+N vs Frequency

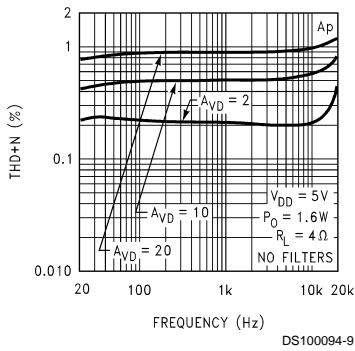

THD+N vs Frequency

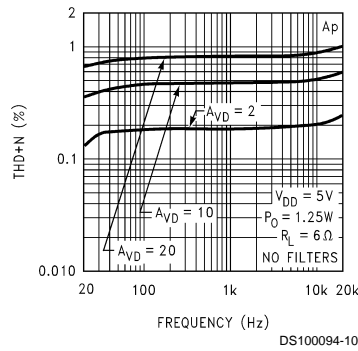

THD+N vs Frequency

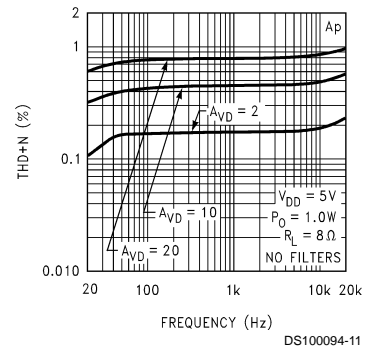

THD+N vs Output Power

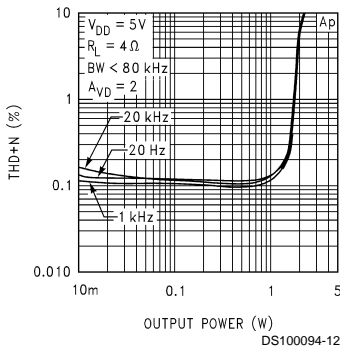

THD+N vs Output Power

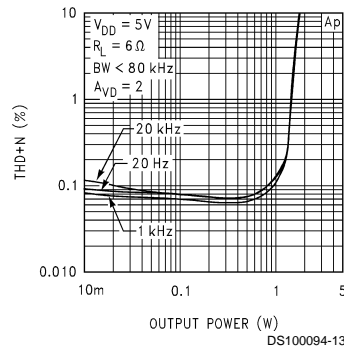

THD+N vs Output Power

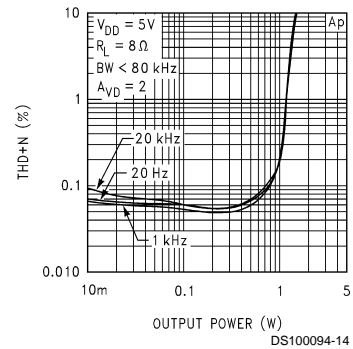

Supply Current vs Supply Voltage

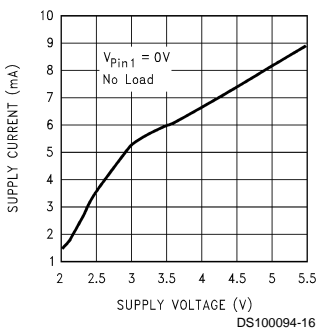

Power Derating Curve

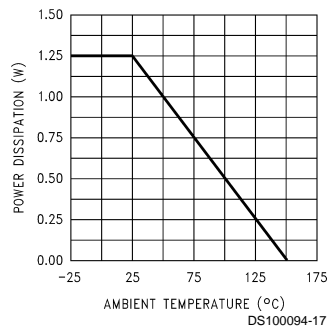

LM4870 Noise Floor vs Frequency

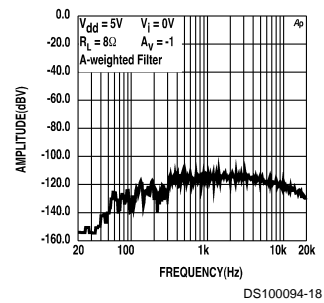

Typical Performance Characteristics (Continued)

Supply Current Distribution vs Temperature

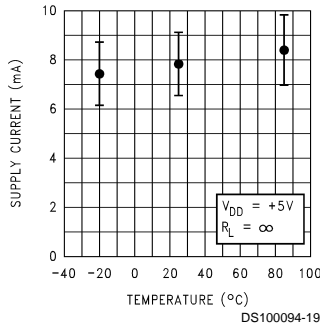

Power Dissipation vs Output Power

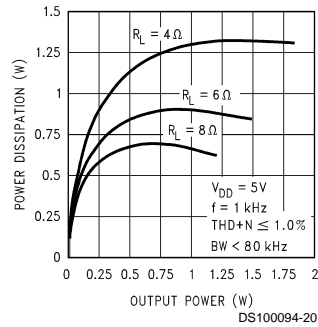

Output Power vs Load Resistance

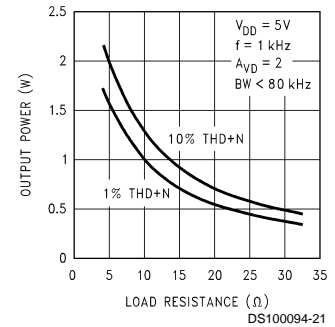

Output Power vs Supply Voltage

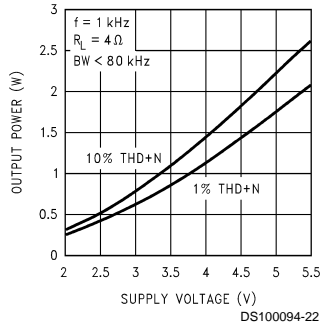

Output Power vs Supply Voltage

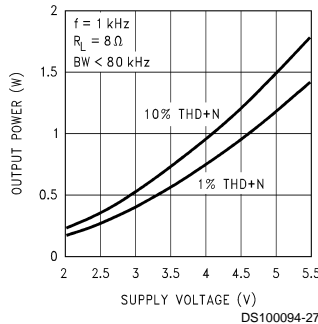

Open Loop Frequency Response

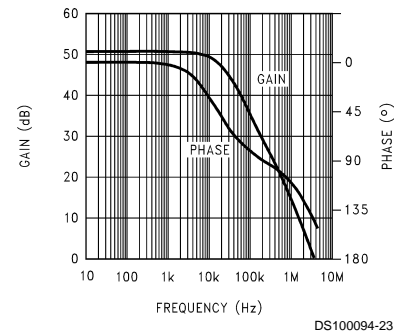

Power Supply Rejection Ratio

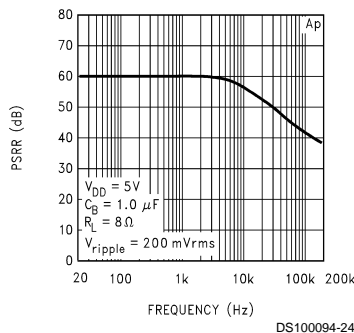

Application Information

BRIDGE CONFIGURATION EXPLANATION

As shown in Figure 1, the LM4870 has two operational amplifiers internally, allowing for a few different amplifier configurations. The first amplifier's gain is externally configurable, while the second amplifier is internally fixed in a unity-gain, inverting configuration. The closed-loop gain of the first amplifier is set by selecting the ratio of R_f to R_i while the second amplifier's gain is fixed by the two internal 40 k Ω resistors. Figure 1 shows that the output of amplifier one serves as the input to amplifier two which results in both amplifiers producing signals identical in magnitude, but out of phase 180°. Consequently, the differential gain for the IC is:

$$A_{vd} = 2 * (R_f/R_i)$$

By driving the load differentially through outputs V_{O1} and V_{O2} , an amplifier configuration commonly referred to as "bridged mode" is established. Bridged mode operation is different from the classical single-ended amplifier configuration where one side of its load is connected to ground.

A bridge amplifier design has a few distinct advantages over the single-ended configuration, as it provides differential drive to the load, thus doubling output swing for a specified supply voltage. Consequently, four times the output power is possible as compared to a single-ended amplifier under the same conditions. This increase in attainable output power assumes that the amplifier is not current limited or clipped. In order to choose an amplifier's closed-loop gain without caus-

Application Information (Continued)

ing excessive clipping which will damage high frequency transducers used in loudspeaker systems, please refer to the **Audio Power Amplifier Design** section.

A bridge configuration, such as the one used in Boomer Audio Power Amplifiers, also creates a second advantage over single-ended amplifiers. Since the differential outputs, V_{O1} and V_{O2} , are biased at half-supply, no net DC voltage exists across the load. This eliminates the need for an output coupling capacitor which is required in a single supply, single-ended amplifier configuration. Without a large output coupling capacitor in a single supply single-ended amplifier, the half-supply bias across the load would result in both increased internal IC power dissipation.

POWER DISSIPATION

Power dissipation is a major concern when designing a successful amplifier, whether the amplifier is bridged or single-ended. A direct consequence of the increased power delivered to the load by a bridge amplifier is an increase in internal power dissipation. Equation 1 states the maximum power dissipation point for a bridge amplifier operating at a given supply voltage and driving a specified output load.

$$P_{DMAX} = 4 * (V_{DD})^2 / (2\pi^2 R_L) \quad (1)$$

Since the LM4870 has two operational amplifiers in one package, the maximum internal power dissipation is 4 times that of a single-ended amplifier. Even with this substantial increase in power dissipation, the LM4870 does not require heatsinking. From Equation 1, assuming a 5V power supply and an 8Ω load, the maximum power dissipation point is 625 mW. The maximum power dissipation point obtained from Equation 1 must not be greater than the power dissipation that results from Equation 2:

$$P_{DMAX} = (T_{JMAX} - T_A) / \theta_{JA} \quad (2)$$

For the LM4870 surface mount package, $\theta_{JA} = 100^\circ\text{C/W}$ and $T_{JMAX} = 150^\circ\text{C}$. Depending on the ambient temperature, T_A , of the system surroundings, Equation 2 can be used to find the maximum internal power dissipation supported by the IC packaging. If the result of Equation 1 is greater than that of Equation 2, then either the supply voltage must be decreased or the load impedance increased. For the typical application of a 5V power supply, with an 8Ω load, the maximum ambient temperature possible without violating the maximum junction temperature is approximately 88°C, provided that device operation is around the maximum power dissipation point. Power dissipation is a function of output power and thus, if typical operation is not around the maximum power dissipation point, the ambient temperature can be increased. Refer to the **Typical Performance Characteristics** curves for power dissipation information for lower output powers.

POWER SUPPLY BYPASSING

As with any power amplifier, proper supply bypassing is critical for low noise performance and high power supply rejection. The capacitor location on both the bypass and power supply pins should be as close to the device as possible. As displayed in the **Typical Performance Characteristics** section, the effect of a larger half-supply bypass capacitor is improved low frequency THD+N due to increased half-supply stability. Typical applications employ a 5V regulator with a 10 μF tantalum and a 0.1 μF film bypass capacitors which aid in supply stability, but do not eliminate the need for bypassing the supply nodes of the LM4870. The selection of

bypass capacitors, especially C_B , is thus dependant upon desired low frequency THD+N, system cost, and size constraints.

SHUTDOWN FUNCTION

In order to reduce power consumption while not in use, the LM4870 contains a shutdown pin to externally turn off the amplifier's bias circuitry. The shutdown feature turns the amplifier off when a logic high is placed on the shutdown pin. Upon going into shutdown, the output is immediately disconnected from the speaker. There is a built-in threshold which produces a drop in quiescent current to 500 μA typically. For a 5V power supply, this threshold occurs when 2V–3V is applied to the shutdown pin. A typical quiescent current of 0.6 μA results when the supply voltage is applied to the shutdown pin. In many applications, a microcontroller or micro-processor output is used to control the shutdown circuitry which provides a quick, smooth transition into shutdown. Another solution is to use a single-pole, single-throw switch that when closed, is connected to ground and enables the amplifier. If the switch is open, then a soft pull-up resistor of 47 kΩ will disable the LM4870. There are no soft pull-down resistors inside the LM4870, so a definite shutdown pin voltage must be applied externally, or the internal logic gate will be left floating which could disable the amplifier unexpectedly.

HEADPHONE CONTROL INPUTS

The LM4870 possesses two headphone control inputs that disable the amplifier and reduce I_{DD} to less than 1 mA when either one or both of these inputs have a logic-high voltage placed on their pins.

Unlike the shutdown function, the headphone control function does not provide the level of current conservation that is required for battery powered systems. Since the quiescent current resulting from the headphone control function is 1000 times more than the shutdown function, the residual currents in the device may create a pop at the output when coming out of the headphone control mode. The pop effect may be eliminated by connecting the headphone sensing output to the shutdown pin input as shown in *Figure 2*. This solution will not only eliminate the output pop, but will also utilize the full current conservation of the shutdown function by reducing I_{DD} to 0.6 μA. The amplifier will then be fully shutdown. This configuration also allows the designer to use the control inputs as either two headphone control pins or a headphone control pin and a shutdown pin where the lowest level of current consumption is obtained from either function.

Figure 3 shows the implementation of the LM4870's headphone control function using a single-supply headphone amplifier. The voltage divider of R1 and R2 sets the voltage at the HP-IN1 pin to be approximately 50 mV when there are no headphones plugged into the system. This logic-low voltage at the HP-IN1 pin enables the LM4870 to amplify AC signals. Resistor R3 limits the amount of current flowing out of the HP-IN1 pin when the voltage at that pin goes below ground resulting from the music coming from the headphone amplifier. The output coupling cap protects the headphones by blocking the amplifier's half-supply DC voltage. The capacitor also protects the headphone amplifier from the low voltage set up by resistors R1 and R2 when there aren't any headphones plugged into the system. The tricky point to this setup is that the AC output voltage of the headphone amplifier cannot exceed the 2.0V HP-IN1 voltage threshold when there aren't any headphones plugged into the system, assuming that R1 and R2 are 100k and 1k, respectively. The LM4870 may not be fully shutdown when this level is ex-

Application Information (Continued)

ceeded momentarily, due to the discharging time constant of the bias-pin voltage. This time constant is established by the two 50k resistors (in parallel) with the series bypass capacitor value.

When a set of headphones are plugged into the system, the contact pin of the headphone jack is disconnected from the signal pin, interrupting the voltage divider set up by resistors R1 and R2. Resistor R1 then pulls up the HP-IN1 pin, enabling the headphone function and disabling the LM4870 amplifier. The headphone amplifier then drives the headphones, whose impedance is in parallel with resistor R2. Since the typical impedance of headphones are 32Ω, resistor R2 has negligible effect on the output drive capability. Also shown in *Figure 3* are the electrical connections for the headphone jack and plug. A 3-wire plug consists of a Tip, Ring, and Sleeve, where the Tip and Ring are signal carrying conductors and the Sleeve is the common ground return. One control pin contact for each headphone jack is sufficient to indicate to control inputs that the user has inserted a plug into a jack and that another mode of operation is desired.

For a system implementation where the headphone amplifier is designed using a split supply, the output coupling cap, C_C and resistor R2 of *Figure 3*, can be eliminated. The functionality described earlier remains the same, however.

In addition, the HP-SENSE pin, although it may be connected to the SHUTDOWN pin as shown in *Figure 2*, may still be used as a control flag. It is capable of driving the input to another logic gate or approximately 2 mA without serious loading.

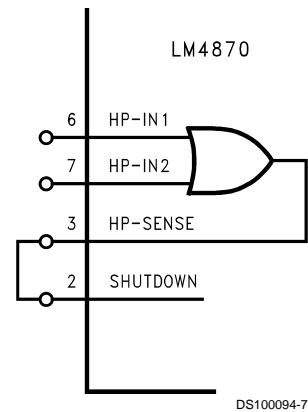

FIGURE 2. HP-SENSE Pin to SHUTDOWN Pin Connection

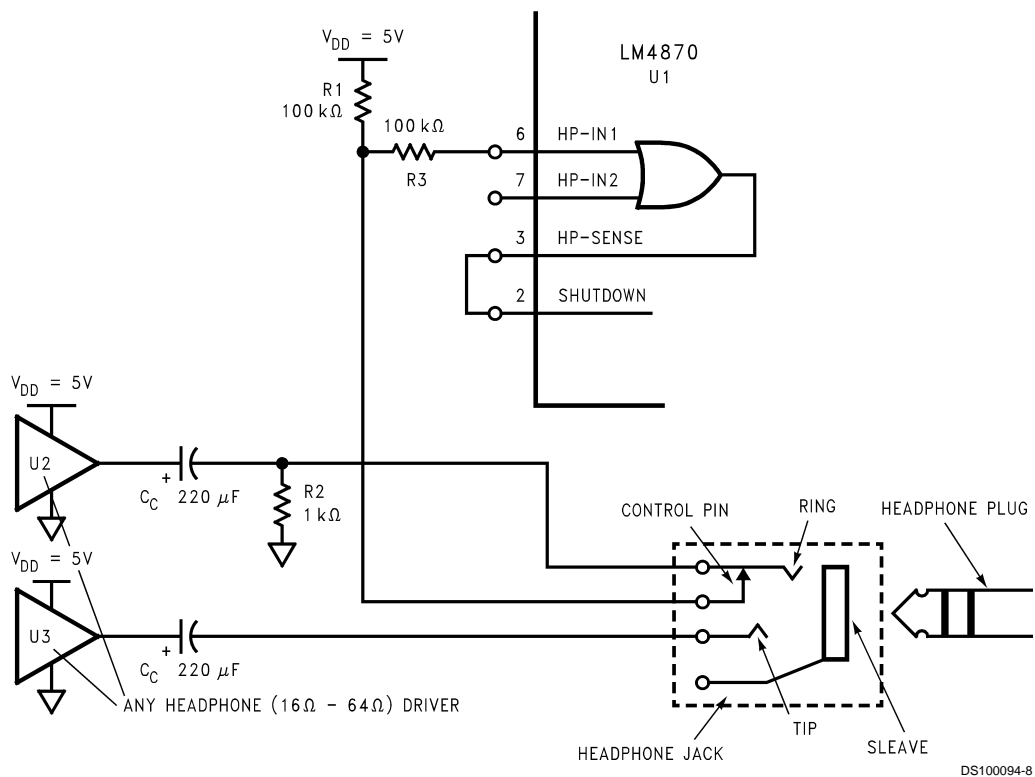

FIGURE 3. Typical Headphone Control Input Circuitry

AUDIO POWER AMPLIFIER DESIGN

Design a 500 mW/8Ω Audio Amplifier

Given:

Power Output: 1.0Wrms

Load Impedance: 8Ω

Input Level: 1 Vrms(max)

Input Impedance: 20 kΩ

Bandwidth: 100 Hz-20 kHz ±0.25 dB

A designer must first determine the needed supply rail to obtain the specified output power. The Output Power vs Supply Voltage graphs in the **Typical Performance Characteristics** section show how much power the LM4870 will output given different supply voltage. According to the graph, 4.6V

Application Information (Continued)

are required for 1.0W of output power. Since 5V rails are common, it is chosen to be the supply voltage. Supply voltage (up to a maximum of 5.5V) above the required 4.6V will allow the LM4870 to reproduce transient signals at greater than 1.0W of output power. The extra voltage will also increase the device power dissipation, so the designer must make sure that the conditions explained in the **Power Dissipation** section are not violated.

Once the power dissipation issues have been addressed, the required differential gain can be determined from Equation 4:

$$A_{vd} \geq 2 * \sqrt{(P_O R_L) / (V_{IN})} = V_{orms} / V_{inrms} \quad (4)$$

$$R_f / R_j = A_{vd} / 2 \quad (5)$$

From equation 4, the minimum A_{vd} is $A_{vd} = 2.83$; use $A_{vd} = 3$.

Since the amplifier output is bridged, giving a gain of 2, and the desired system gain is 3, the ratio of feedback (R_f) to in-

put (R_i) resistor is 1.5:1. If R_i is set to the required input impedance of 20 k Ω , then $R_f = 30$ k Ω . The final design step is to address the bandwidth requirements which must be stated as a pair of -3 dB frequency points. Five times away from a -3 dB point is 0.17 dB down from passband response which is better than the required ± 0.25 dB specified.

$$f_L = 100 \text{ Hz} / 5 = 20 \text{ Hz}$$

$f_H = 20 \text{ kHz} \times 5 = 100 \text{ Hz}$ As stated in the **External Components** section, R_i in conjunction with C_i create a high-pass filter.

$$C_i \geq 1 / (2\pi * 20 \text{ k}\Omega * 20 \text{ Hz}) = 0.397 \mu\text{F}; \text{ use } 0.39 \mu\text{F}.$$

The high frequency pole is determined by the product of the desired high frequency pole, f_H , and the differential gain, A_{vd} . With a $A_{vd} = 3$ and $f_H = 100$ kHz, the resulting GBWP = 150 kHz which is much smaller than the LM4870 GBWP of 4 MHz. This figure displays that if a designer has a need to design an amplifier with a higher differential gain, the LM4870 can still be used without running into bandwidth problems.

Physical Dimensions inches (millimeters) unless otherwise noted

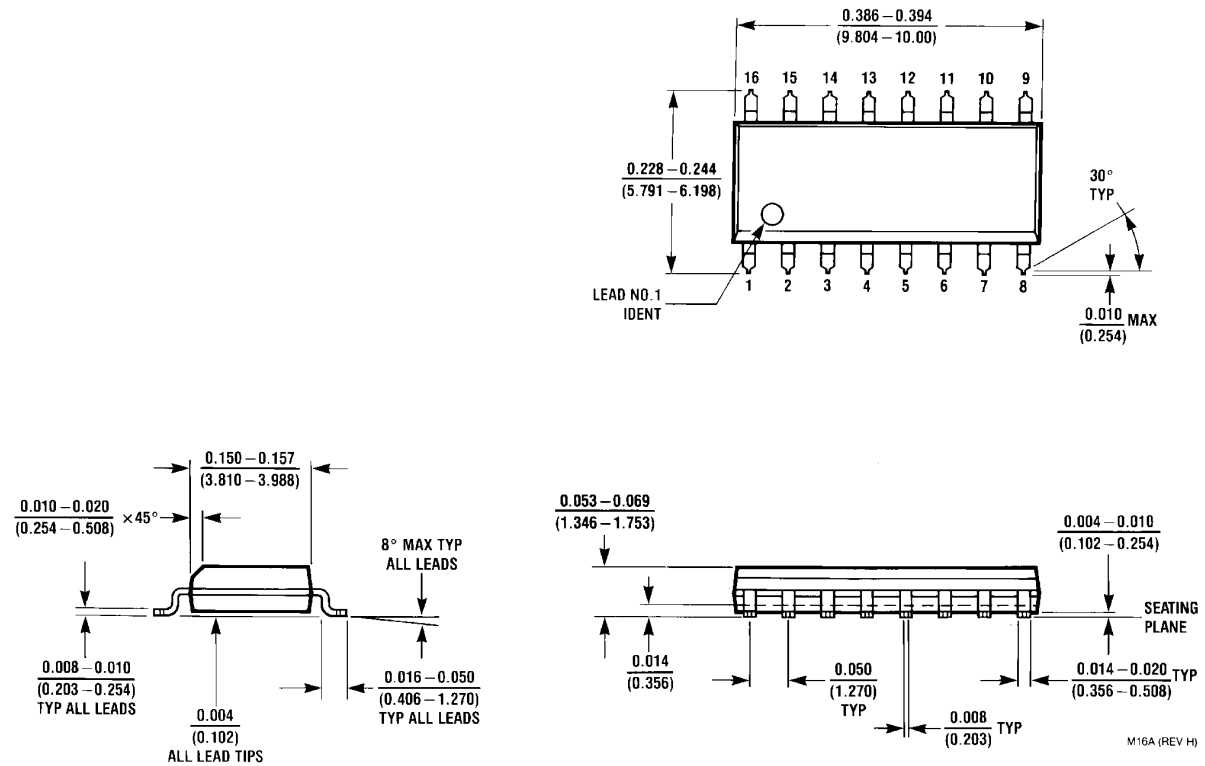

**Small Outline Package (M)
Order Number LM4870M
NS Package Number M16A**

LIFE SUPPORT POLICY

NATIONAL'S PRODUCTS ARE NOT AUTHORIZED FOR USE AS CRITICAL COMPONENTS IN LIFE SUPPORT DEVICES OR SYSTEMS WITHOUT THE EXPRESS WRITTEN APPROVAL OF THE PRESIDENT AND GENERAL COUNSEL OF NATIONAL SEMICONDUCTOR CORPORATION. As used herein:

1. Life support devices or systems are devices or systems which, (a) are intended for surgical implant into the body, or (b) support or sustain life, and whose failure to perform when properly used in accordance with instructions for use provided in the labeling, can be reasonably expected to result in a significant injury to the user.
2. A critical component is any component of a life support device or system whose failure to perform can be reasonably expected to cause the failure of the life support device or system, or to affect its safety or effectiveness.

 **National Semiconductor Corporation**
Americas
Tel: 1-800-272-9959
Fax: 1-800-737-7018
Email: support@nsc.com
www.national.com

National Semiconductor Europe
Fax: +49 (0) 180-530 85 86
Email: europe.support@nsc.com
Deutsch Tel: +49 (0) 69 9508 6208
English Tel: +44 (0) 870 24 0 2171
Français Tel: +33 (0) 1 41 91 87 90

National Semiconductor Asia Pacific Customer Response Group
Tel: 65-2544466
Fax: 65-2504466
Email: ap.support@nsc.com

National Semiconductor Japan Ltd.
Tel: 81-3-5639-7560
Email: nsj.crc@jksmtp.nsc.com
Fax: 81-3-5639-7507