

DESCRIPTION

The LM385/385B Micropower Voltage References are two terminal bandgap reference diodes designed and optimized for accurate low power operation in portable and other power sensitive systems. Operating currents are guaranteed from as low as 15 μ A up to 20mA for the LX385/385B-1.2, and 20 μ A up to 20mA for the LM385/385B-2.5, giving designers a great deal of flexibility in optimizing power consumption, noise and ultimate application performance. As an added feature, the references output impedance is extraordinarily low over the entire operating range of quiescent current. This enables an extremely wide dynamic load range with little effect on the overall reference accuracy.

IMPORTANT: For the most current data, consult MICROSEMI's website: <http://www.microsemi.com>

The LM385 family is available in fixed 1.2V and 2.5V reference values. Process and circuit design optimization provides for high accuracy with initial tolerance values of 1% for the LM385B-1.2, 2% for the LM385-1.2, 1.5% for the LM385B-2.5, and 3% for the LM385-2.5. Complementing their initial accuracy, the bandgap reference is temperature compensated to deliver 20ppm performance over the 0° to 70°C operating temperature range.

The LM385 family from Linfoinity is a pin-to-pin replacement for the LM385/385B family of voltage references.

KEY FEATURES

- Guaranteed 1% Initial Accuracy (LM385B-1.2)
- Guaranteed 2.5% Initial Accuracy (LM385-1.2)
- Guaranteed 1.5% Initial Accuracy (LM385B-2.5)
- Guaranteed 3.0% Initial Accuracy (LM385-2.5)
- Guaranteed 20 μ A Operating Current
- Low Temperature coefficient
- Operating Current of 20 μ A to 20mA
- Very Low Dynamic Impedance: 10 Ω

APPLICATIONS

- Portable Meter References
- Portable Test Instruments
- Battery Operated Systems
- Current Loop Instrumentation

PRODUCT HIGHLIGHT

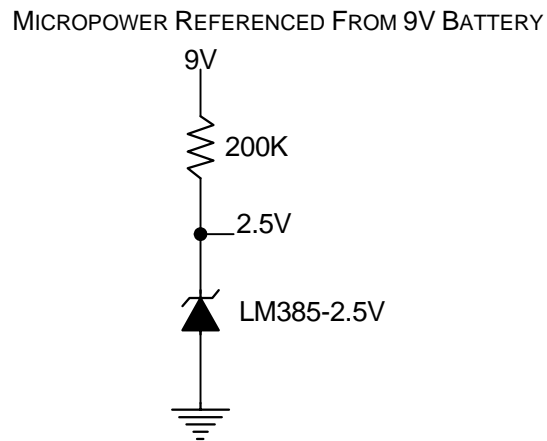
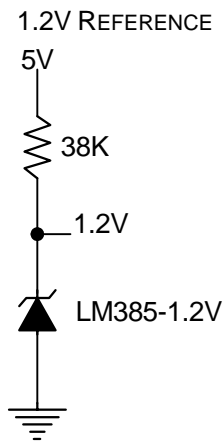

PACKAGE ORDER INFO

T _A (°C)	Reference Voltage	Initial Tolerance	DM	Plastic SOIC 8-Pin	LP	Plastic TO-92 3-Pin
			RoHS Compliant / Pb-free Transition DC: 0440		RoHS Compliant / Pb-free Transition DC: 0509	
0 to 70	1.2V	±30mV	LM385DM-1.2	LM385LP-1.2		
		±12mV	LM385BDM-1.2	LM385BLP-1.2		
	2.5V	±75mV	LM385DM-2.5	LM385LP-2.5		
		±38mV	LM385BDM-2.5	LM385BLP-2.5		

Note: Available in Tape & Reel. Append the letters "TR" to the part number. (i.e. LX385BDM-TR)

LM385/385B

1.2 & 2.5V MICROPOWER VOLTAGE REFERENCE

PRODUCTION DATA SHEET

ABSOLUTE MAXIMUM RATINGS (Note 1)

Reverse Breakdown Current	30mA
Forward Current	10mA
Operating Temperature Range	
LM385	0°C to 70°C
Storage Temperature Range	-65°C to 150°C
Lead Temperature (soldering, 10 seconds)	300°C
Pb-free / RoHS Peak Package Solder Reflow Temp (40second max. exposure)	260°C (+0, -5)

Note 1. Values beyond which damage may occur. All voltages are specified with respect to ground, and all currents are positive into the specified terminal

THERMAL DATA

DM PACKAGE:

THERMAL RESISTANCE-JUNCTION TO AMBIENT, θ_{JA}	165°C/W
---	---------

LP PACKAGE:

THERMAL RESISTANCE-JUNCTION TO AMBIENT, θ_{JA}	165°C/W
---	---------

The θ_{JA} numbers are guidelines for the thermal performance of the device/pc-board system. All of the above assume no ambient airflow.

PACKAGE PIN OUTS

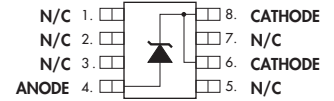

DM PACKAGE

(Top View)

100% Pb-free / RoHS Matte Tin Lead Finish

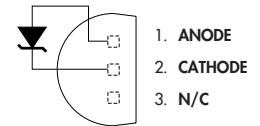

LP PACKAGE

(Top View)

1.2 & 2.5V MICROPOWER VOLTAGE REFERENCE

PRODUCTION DATA SHEET

ELECTRICAL CHARACTERISTICS

(Unless otherwise specified, these specifications apply to $T_A = 25^\circ\text{C}$. Typ number represents $T_A = 25^\circ\text{C}$ value.)

LM385/385B-1.2

Parameter	Symbol	Test Conditions	LM385/385B-1.2			Units
			Min.	Typ.	Max.	
Reverse Breakdown Voltage	LM385	V_Z $I_{MIN} \leq I_R \leq I_{MAX}$	1.205	1.235	1.260	V
	LM385B		1.223	1.235	1.247	V
Average Temperature Coefficient	$\frac{\Delta V_Z}{\Delta \text{Temp}}$	$I_R = 100\mu\text{A}$		20		ppm/ $^\circ\text{C}$
Minimum Operating Current	I_{MIN}			8	15	μA
Reverse Breakdown Voltage Change with Current	e	ΔV_Z $I_{MIN} \leq I_R \leq 1\text{mA}$			1.5	mV
	ΔI_R	$1\text{mA} \leq I_R \leq 20\text{mA}$			20	mV
Reverse Dynamic Impedance	r_z	$I_R = 100\mu\text{A}$		1		Ω
Wide Band Noise (RMS)	e_n	$I_R = 100\mu\text{A}$, $10\text{Hz} \leq f \leq 10\text{kHz}$		60		μV
Long Term Stability	$\frac{\Delta V_Z}{\Delta \text{Time}}$	$I_R = 100\mu\text{A}$, $T_A = 25^\circ\text{C} \pm 0.1^\circ\text{C}$		20		ppm/kHr

LM385/385B-2.5

Parameter	Symbol	Test Conditions	LM385/385B-2.5			Units
			Min.	Typ.	Max.	
Reverse Breakdown Voltage	LM385	V_Z $I_{MIN} \leq I_R \leq I_{MAX}$	2.425	2.500	2.575	V
	LM385B		2.462	2.500	2.538	V
Average Temperature Coefficient	$\frac{\Delta V_Z}{\Delta \text{Temp}}$	$I_R = 100\mu\text{A}$		20		ppm/ $^\circ\text{C}$
Minimum Operating Current	I_{MIN}			13	20	μA
Reverse Breakdown Voltage Change with Current	e	ΔV_Z $I_{MIN} \leq I_R \leq 1\text{mA}$			2	mV
	ΔI_R	$1\text{mA} \leq I_R \leq 20\text{mA}$			20	mV
Reverse Dynamic Impedance	r_z	$I_R = 100\mu\text{A}$, $f = 20\text{Hz}$		1		Ω
Wide Band Noise (RMS)	e_n	$I_R = 100\mu\text{A}$, $10\text{Hz} \leq f \leq 10\text{kHz}$		120		μV
Long Term Stability	$\frac{\Delta V_Z}{\Delta \text{Time}}$	$I_R = 100\mu\text{A}$, $T_A = 25^\circ\text{C} \pm 0.1^\circ\text{C}$		20		ppm/kHr

GRAPH / CURVE INDEX

Characteristic Curves
LM385/385B-1.2

FIGURE

- RESPONSE TIME
- REVERSE CHARACTERISTICS
- FORWARD CHARACTERISTICS
- TEMPERATURE DRIFT
- REVERSE VOLTAGE CHANGE
- REVERSE DYNAMIC IMPEDANCE
- NOISE VOLTAGE

Characteristic Curves
LM385/385B-2.5

FIGURE

- RESPONSE TIME
- REVERSE CHARACTERISTICS
- FORWARD CHARACTERISTICS
- TEMPERATURE DRIFT
- REVERSE DYNAMIC IMPEDANCE
- NOISE VOLTAGE

CHARACTERISTIC CURVES — LM385/385B-1.2V

FIGURE 1. — RESPONSE TIME

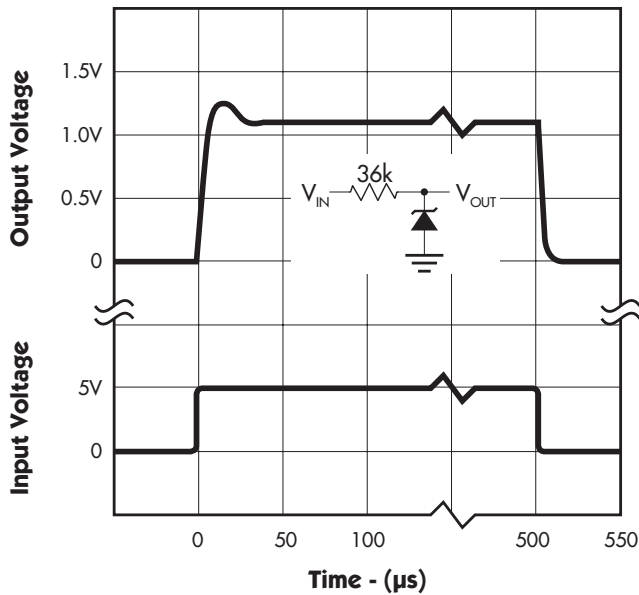

FIGURE 2. — REVERSE CHARACTERISTICS

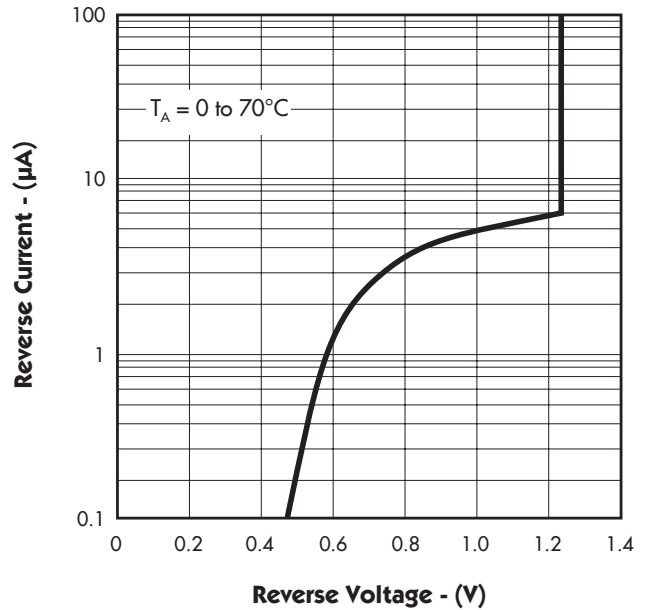

FIGURE 3. — FORWARD CHARACTERISTICS

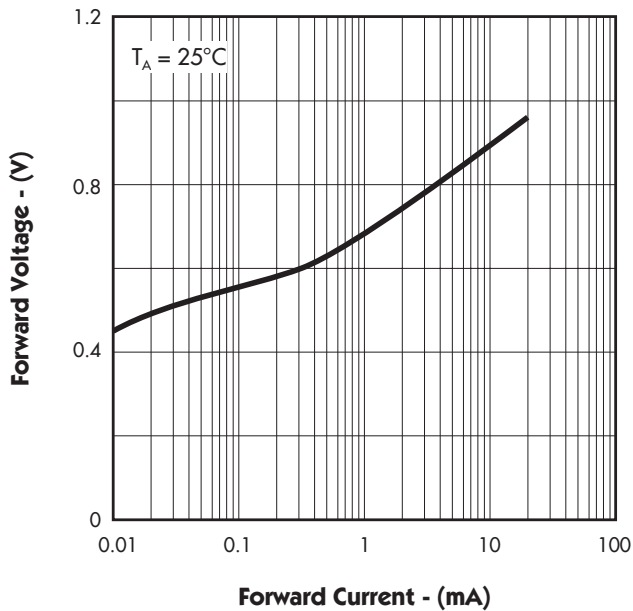
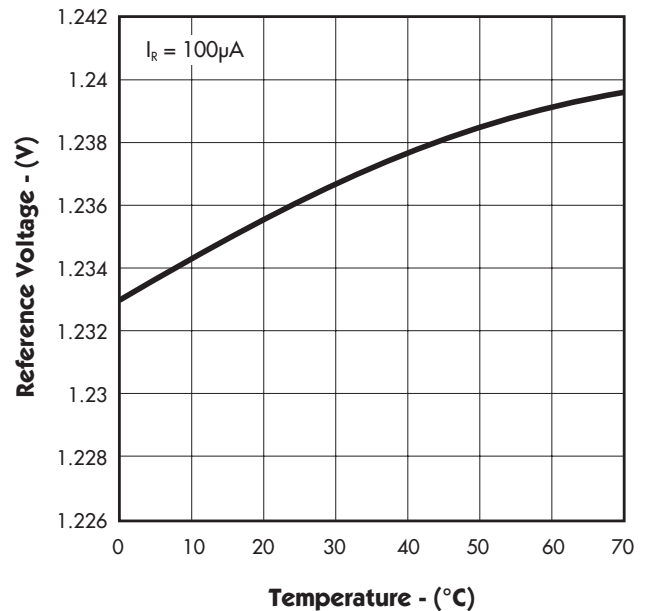

FIGURE 4. — TEMPERATURE DRIFT



1.2 & 2.5V MICROPOWER VOLTAGE REFERENCE

PRODUCTION DATA SHEET

CHARACTERISTIC CURVES — LM385/385B-1.2V

FIGURE 5. — REVERSE VOLTAGE CHANGE

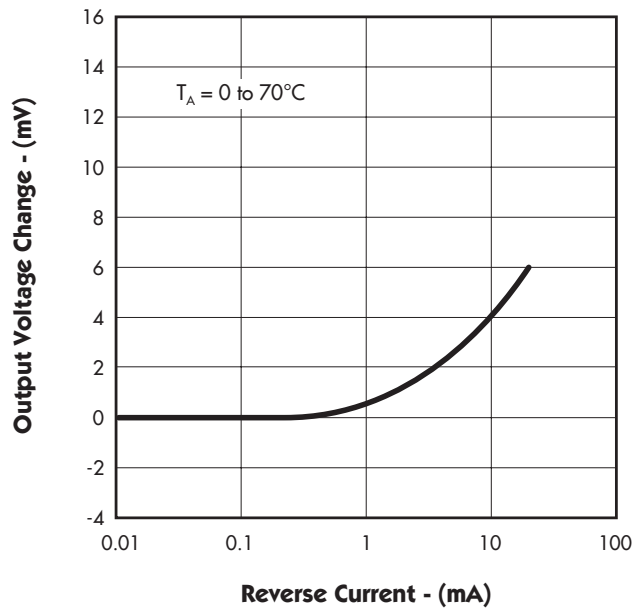

FIGURE 6. — REVERSE DYNAMIC IMPEDANCE

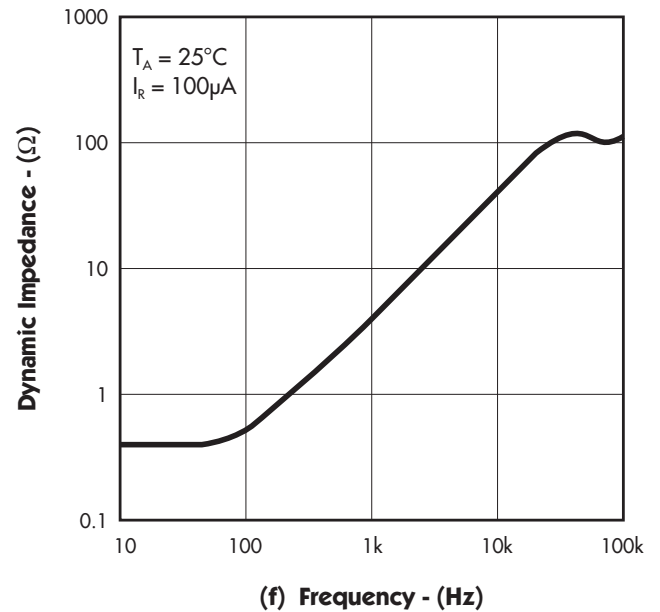
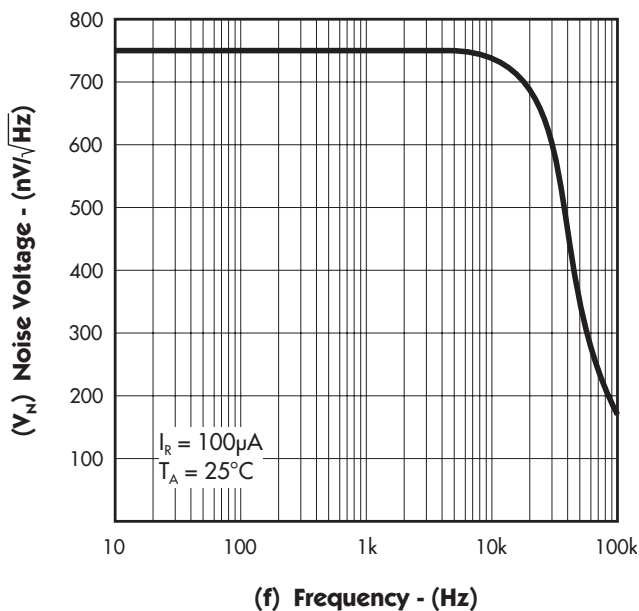

FIGURE 7. — NOISE VOLTAGE



CHARACTERISTIC CURVES — LM385/385B-2.5V

FIGURE 8. — RESPONSE TIME

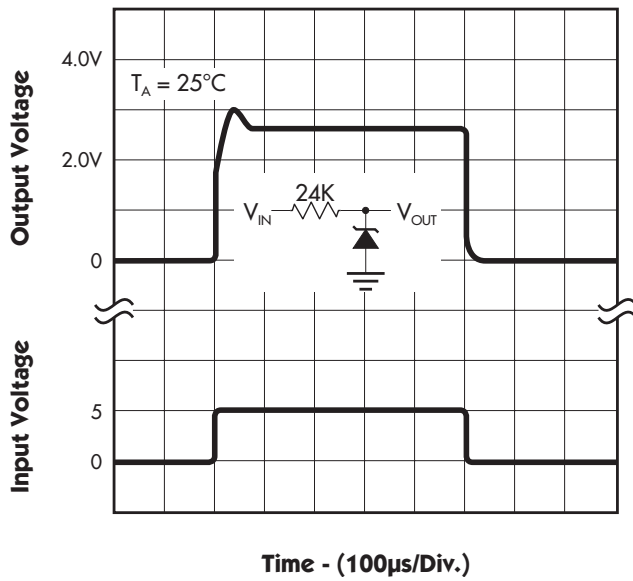

FIGURE 9. — REVERSE CHARACTERISTICS

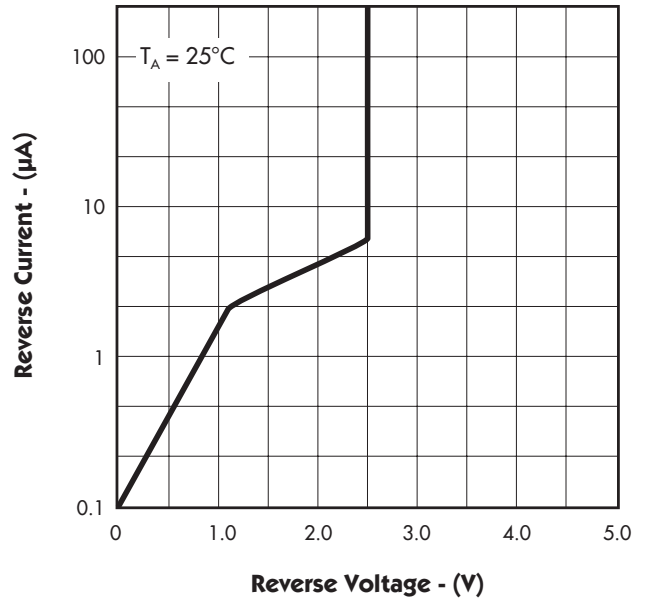

FIGURE 10. — FORWARD CHARACTERISTICS

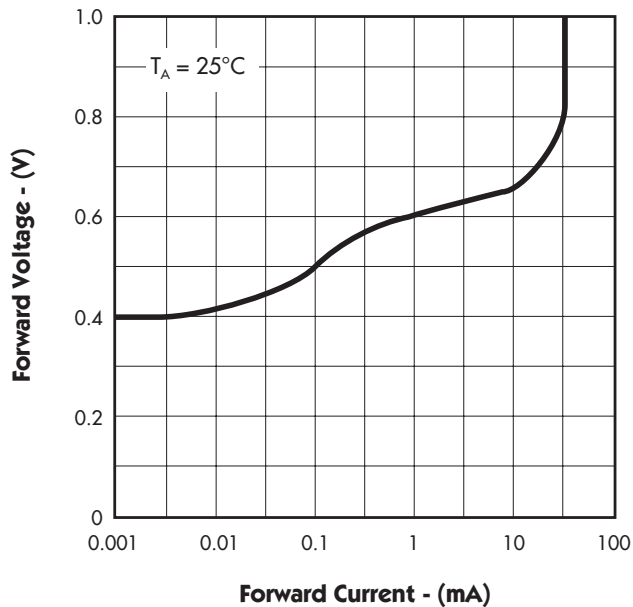
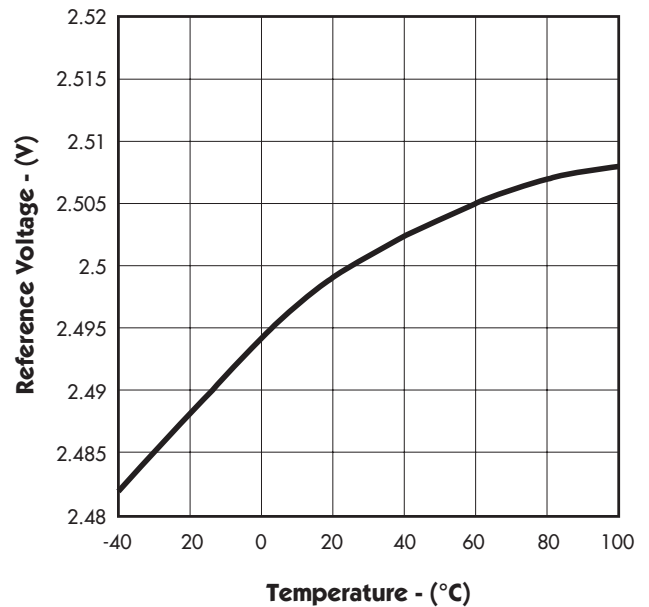

FIGURE 11. — TEMPERATURE DRIFT



1.2 & 2.5V MICROPOWER VOLTAGE REFERENCE

PRODUCTION DATA SHEET

CHARACTERISTIC CURVES — LM385/385B-2.5V

FIGURE 12. — REVERSE DYNAMIC IMPEDANCE

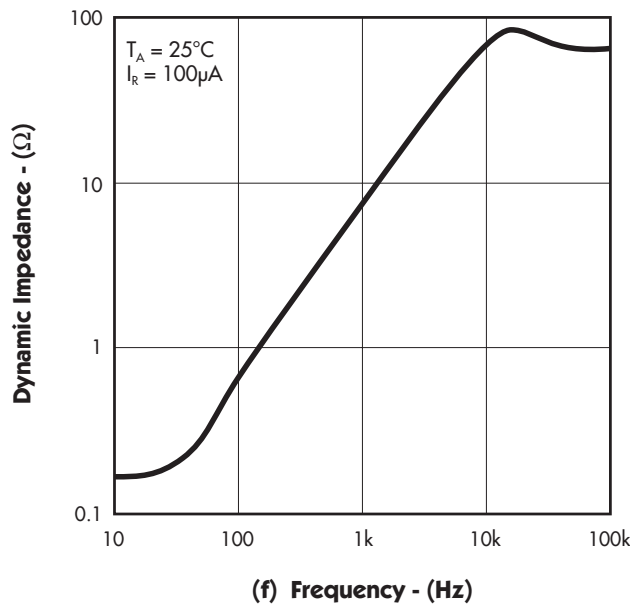

FIGURE 13. — NOISE VOLTAGE

