

# LM3687 Step-Down DC-DC Converter with Integrated Low Dropout Regulator and Startup Mode

Check for Samples: [LM3687](#)

## FEATURES

### DC-DC Converter:

- 750mA Maximum Load Capability
- 1.8MHz PWM Fixed Switching Frequency (Typ.)
- Automatic PFM/PWM Mode Switching
- 27µA typ. Quiescent Current
- Internal Synchronous Rectification for High Efficiency
- Internal Soft Start

### Dual Rail Linear Regulator:

- Startup Mode
  - Load Transients < 25mVpeak Typ.
  - Line Transients < 1mVpeak Typ.
  - Very Low Dropout Voltage: 82mV Typ. at 350mA Load Current
  - $0.7V \leq V_{IN\_LIN} \leq 4.5V$
  - 10µA Typical  $I_Q$  from  $V_{IN\_LIN}$
  - 350mA Maximum Load Capability
- ### Combined Common Features:
- 65µA typical Quiescent Current from  $V_{BATT}$  if Both Regulators are Enabled
  - 750mA Maximum Combined Load Capability in

### Post Regulation Setup (DC-DC 400mA + Linear Regulator 350mA)

- 1100mA Maximum Total Load Capability in Independent Mode of Operation (DC-DC: 750mA, Linear Regulator: 350mA)
- Operates from a Single Li-Ion Cell or 3 Cell NiMH/NiCd Batteries
- Only Four Tiny Surface-Mount External Components Required (One Inductor, Three Ceramic Capacitors)
- Small 9-Bump DSBGA Package
- Over-Temperature, Current Overload and Under-Voltage Protection

## APPLICATIONS

- Mobile Phones
- Hand-Held Radios
- Personal Digital Assistants
- Palm-top PCs
- Portable Instruments
- Battery Powered Devices

## DESCRIPTION

The LM3687 is a step-down DC-DC converter with an integrated low dropout Linear Regulator optimized for powering ultra-low voltage circuits from a single Li-Ion cell or 3 cell NiMH/NiCd batteries. It provides a dual output with fixed output voltages and combined load current up to 750mA in post regulation mode or 1100mA in independent mode of operation, over an input voltage range from 2.7V to 5.5V. There are several different fixed output voltage combinations available (refer to [Voltage Options](#)).

The Linear Regulator being driven from the fixed output voltage of the buck converter (post regulation) translates to high efficiency.

The device offers superior features and performance for mobile phones and similar portable applications with complex power management systems. Automatic intelligent switching between PWM low-noise and PFM low-current mode offers improved efficiency over the full load current range. During full-power operation, a fixed-frequency 1.8MHz (typ.) PWM mode drives loads from ~80mA to 750mA max. Hysteretic PFM mode extends the battery life through reduction of the quiescent current during light loads and system standby.

The LM3687 also features internal protection against over-temperature, current overload and under-voltage conditions.



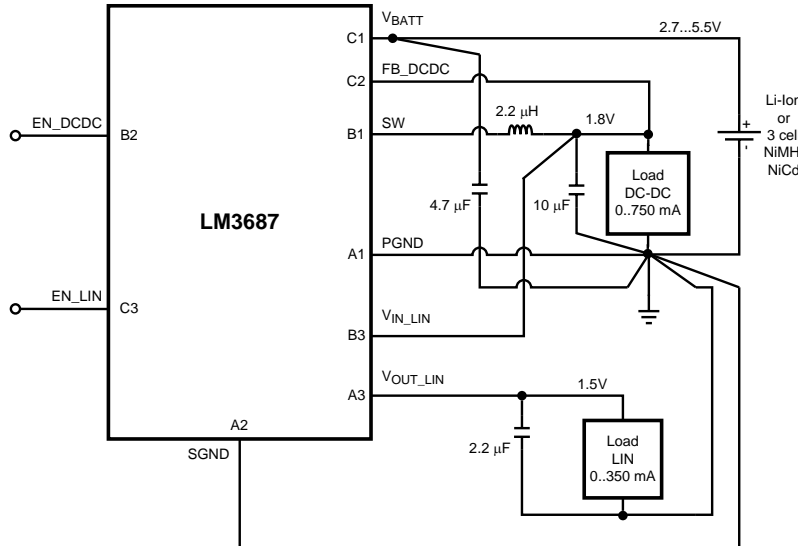
Please be aware that an important notice concerning availability, standard warranty, and use in critical applications of Texas Instruments semiconductor products and disclaimers thereto appears at the end of this data sheet.

All trademarks are the property of their respective owners.

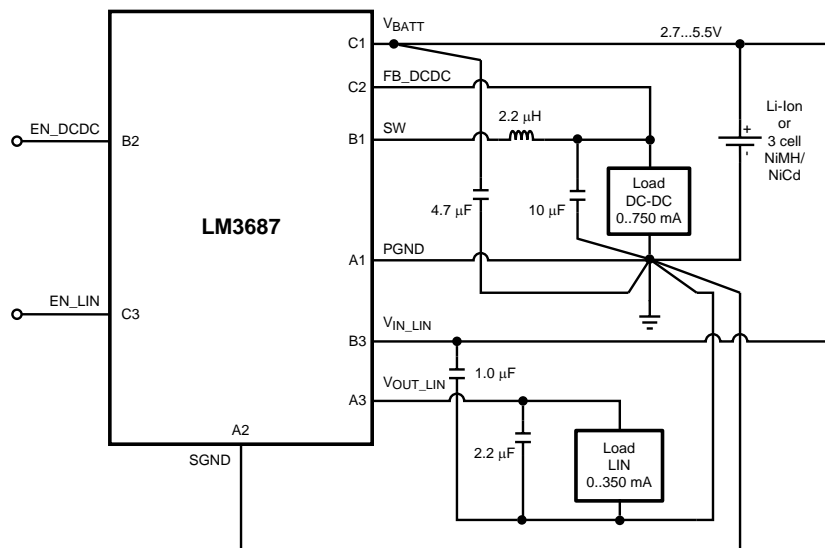
Two enable pins allow the separate operation of either the DC-DC or the Linear Regulator alone or both. If the power input voltage for the Linear Regulator  $V_{IN\_LIN}$  is not sufficiently high (e.g. the DC-DC converter is not enabled or starting up) a startup LDO supplies the Linear Regulator Output from  $V_{BATT}$  for 50mA rated load current (Startup Mode). If  $V_{IN\_LIN}$  is at the required voltage level, the startup LDO is deactivated and the main regulator provides 350mA output current. In shutdown mode (Enable pins pulled low) the device turns off and reduces battery consumption to 0.1 $\mu$ A (typ.).

The LM3687 is available in a tiny, lead-free (NO PB) 9-bump DSBGA package. A high switching frequency of 1.8MHz (typ.) allows the use of tiny surface-mount components. Only four external components -one inductor and three ceramic capacitors- are required.

**Typical Application Circuit**

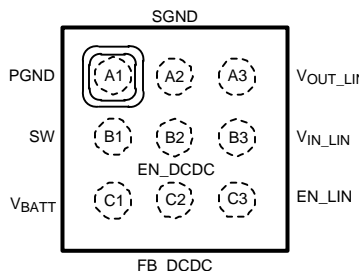


**Figure 1. Typical Application Circuit: Linear Regulator as Post Regulator**



**Figure 2. Typical Application Circuit: Independent Mode of Operation**

**Connection Diagram**



**Figure 3. Connection Diagram 9-Bump Thin DSBGA Package  
Top View  
(See Package Number YZR0009BBA)**

**PIN DESCRIPTIONS**

Pin Number	Pin Name	Description
A1	PGND	Power Ground pin
A2	SGND	Signal Ground pin
A3	V <sub>OUT_LIN</sub>	Voltage Output of the linear regulator
B1	SW	Switching Node Connection to the internal PFET switch and NFET synchronous rectifier
B2	EN_DCDC	Enable Input for the DC-DC converter. The DC-DC converter is in shutdown mode if voltage at this pin is < 0.4V and enabled if > 1.0V. Do not leave this pin floating. Please see <a href="#">Enable Combinations</a> .
B3	V <sub>IN_LIN</sub>	Power Supply Input for the linear regulator
C1	V <sub>BATT</sub>	Power Supply for the DC-DC output stage and internal circuitry. Connect to the input filter capacitor (see <a href="#">Typical Application Circuit</a> ).
C2	FB_DCDC	Feedback Analog Input for the DC-DC converter. Connect directly to the output filter capacitor.
C3	EN_LIN	Enable Input for the linear regulator. The linear regulator is in shutdown mode if voltage at this pin is < 0.4V and enabled if > 1.0V. Do not leave this pin floating. Please see <a href="#">Enable Combinations</a> .

## Voltage Options

DC-DC Converter Output: $V_{OUT\_DCDC}$	Linear Regulator Output: $V_{OUT\_LIN}$
1.80V	1.50V
1.80V	1.20V
1.80V <sup>(1)</sup>	1.30V <sup>(1)</sup>

(1) For availability of these or other output voltage combinations please contact your local Texas Instruments sales office

## Enable Combinations

EN_DCDC	EN_LIN	Comments
0	0	No Outputs
0	1	Linear Regulator enabled only <sup>(1)</sup>
1	0	DC-DC converter enabled only
1	1	DC-DC converter and linear regulator active <sup>(1)</sup>

(1) Startup Mode

### Startup Mode:

$V_{IN\_LIN}$  must be higher than  $V_{OUT\_LIN(NOM)} + 200mV$  in order to enable the main regulator ( $I_{MAX} = 350mA$ ).

If  $V_{IN\_LIN} < V_{OUT\_LIN(NOM)} + 100mV$  (100mV hysteresis), the startup LDO ( $I_{MAX} = 50mA$ ) is active, supplied from  $V_{BATT}$ .

For example in the typical post regulation application the LDO will remain in startup mode until the DC-DC converter has ramped up its output voltage.



These devices have limited built-in ESD protection. The leads should be shorted together or the device placed in conductive foam during storage or handling to prevent electrostatic damage to the MOS gates.

## Absolute Maximum Ratings <sup>(1)(2)(3)</sup>

$V_{IN\_LIN}$ , $V_{BATT}$ pins: Voltage to GND, $V_{IN\_LIN} \leq V_{BATT}$	-0.2V to 6.0V
$V_{IN\_LIN}$ pin to $V_{BATT}$ pin	0.2V
Enable pins, Feedback pin, SW pin	(GND-0.2V) to ( $V_{BATT}+0.2V$ ) with 6.0V max
Continuous Power Dissipation <sup>(4)</sup>	Internally Limited
Junction Temperature ( $T_{J-MAX}$ )	150°C
Storage Temperature Range	-65°C to + 150°C
Package Peak Reflow Temperature (Pb-free, 10-20 sec.) <sup>(5)</sup>	260°C
ESD Rating <sup>(6)</sup>	
Human Body Model:	2.0kV
Machine Model	200V

(1) Absolute Maximum Ratings indicate limits beyond which damage to the component may occur. Operating Ratings are conditions under which operation of the device is guaranteed. Operating Ratings do not imply guaranteed performance limits. For guaranteed performance limits and associated test conditions, see the Electrical Characteristics tables.

(2) All voltages are with respect to the potential at the SGND pin.

(3) If Military/Aerospace specified devices are required, please contact the Texas Instruments Sales Office/ Distributors for availability and specifications.

(4) Internal thermal shutdown circuitry protects the device from permanent damage. Thermal shutdown engages at  $T_J = 160^\circ C$  (typ.) and disengages at  $T_J = 140^\circ C$  (typ.).

(5) For detailed soldering specifications and information, please refer to Application Note 1112: DSBGA Wafer Level Chip Scale Package (AN-1112).

(6) The Human body model is a 100pF capacitor discharged through a 1.5k $\Omega$  resistor into each pin. The machine model is a 200pF capacitor discharged directly into each pin. (MIL-STD-883 3015.7)

**Operating Ratings (1)(2)**

Input Voltage Range $V_{BATT}$ (3)	2.7V to 5.5V ( $\geq V_{OUT\_LIN(NOM)} + 1.5V$ and $\geq V_{OUT\_DCDC(NOM)} + 1.0V$ )
Input Voltage Range $V_{IN\_LIN}$	( $V_{OUT\_LIN(NOM)} + 0.25V$ ) to 4.5V
Junction Temperature ( $T_J$ ) Range	-30°C to +125°C
Ambient Temperature ( $T_A$ ) Range (4)	-30°C to +125°C

- (1) Absolute Maximum Ratings indicate limits beyond which damage to the component may occur. Operating Ratings are conditions under which operation of the device is guaranteed. Operating Ratings do not imply guaranteed performance limits. For guaranteed performance limits and associated test conditions, see the Electrical Characteristics tables.
- (2) All voltages are with respect to the potential at the SGND pin.
- (3) The battery input voltage range recommended for ideal applications performance for the specified output voltages is given as follows:  
 $V_{BATT} = 2.7V$  to  $5.5V$  for  $1.0V < V_{OUT\_DCDC} < 1.8V$ ;  $V_{BATT} = (V_{OUT\_DCDC} + 1V)$  to  $5.5V$  for  $1.8V \leq V_{OUT\_DCDC} \leq 1.875V$
- (4) In applications where high power dissipation and/or poor package thermal resistance is present, the maximum ambient temperature may have to be derated. Maximum ambient temperature ( $T_{A-MAX}$ ) is dependent on the maximum operating junction temperature ( $T_{J-MAX-OP} = 125^\circ C$ ), the maximum power dissipation of the device in the application ( $P_{D-MAX}$ ), and the junction-to ambient thermal resistance of the part/package in the application ( $\theta_{JA}$ ), as given by the following equation:  $T_{A-MAX} = T_{J-MAX-OP} - (\theta_{JA} \times P_{D-MAX})$ .

**Thermal Properties**

Junction-to-Ambient Thermal Resistance ( $\theta_{JA}$ ), for 4 layer board <sup>(1)</sup>	
DSBGA 9	70°C/W

- (1) Junction-to-ambient thermal resistance is highly application and board-layout dependent. In applications where high maximum power dissipation exists, special attention must be paid to thermal dissipation issues in board design.

**Electrical Characteristics: DC-DC Converter (1)(2)(3)**

Typical values and limits appearing in standard typeface are for  $T_A = 25^\circ C$ . Limits appearing in **boldface** type apply over the full operating temperature range:  $-30^\circ C \leq T_J \leq +125^\circ C$ . Unless otherwise noted,  $V_{IN\_LIN} = V_{OUT\_LIN(NOM)} + 0.3V$ ,  $V_{BATT} = 3.6V$ ,  $I_{OUT\_LIN} = 1mA$ ,  $V_{EN\_DCDC} = V_{EN\_LIN} = V_{BATT}$ ,  $C_{VBATT} = 4.7\mu F$ ,  $C_{VOUT\_DCDC} = 10\mu F$ ,  $C_{VOUT\_LIN} = 2.2\mu F$ ,  $C_{VIN\_LIN} = 1.0\mu F$ ,  $L = 2.2\mu H$ .

Symbol	Parameter	Conditions	Typical	Limit		Units
				Min	Max	
$V_{FB\_DCDC}$	Feedback Voltage Accuracy	PWM Mode		<b>-2.5</b>	<b>+2.5</b>	%
	Line Regulation	$V_{OUT\_DCDC} + 1.0V \leq V_{BATT} \leq 5.5V$ , $I_{OUT\_DCDC} = 150mA$	0.06			%/V
	Load Regulation	$100mA \leq I_{OUT\_DCDC} \leq 750mA$	0.0005			%/mA
$R_{DSON(P)}$	Pin-Pin Resistance for PFET		280		500	mΩ
$R_{DSON(N)}$	Pin-Pin Resistance for NFET		200		400	mΩ
$I_{LIM\_DCDC}$	Switch Peak Current Limit	Open loop <sup>(4)</sup>	1172	<b>994</b>	<b>1380</b>	mA
$F_{OSC}$	Internal Oscillator Frequency	PWM Mode	1.8	<b>1.3</b>	<b>2.3</b>	MHz

- (1) All voltages are with respect to the potential at the SGND pin.
- (2) Min and Max limits are guaranteed by design, test, or statistical analysis. Typical numbers are not guaranteed, but do represent the most likely norm. Unless otherwise specified, conditions for typ. specifications are:  $V_{BATT} = 3.6V$  and  $T_A = 25^\circ C$ .
- (3) The parameters in the electrical characteristic table are tested at  $V_{BATT} = 3.6V$  unless otherwise specified. For performance over the input voltage range refer to datasheet curves.
- (4) Refer to datasheet curves for closed loop data and its variation with regards to supply voltage and temperature. Electrical Characteristic table reflects open loop data (FB=0V and current drawn from SW pin ramped up until cycle by cycle current limit is activated). Closed loop current limit is the peak inductor current measured in the application circuit by increasing output current until output voltage drops by 10%.

**Electrical Characteristics: Linear Regulator, Normal Mode<sup>(1)(2)</sup>**

Symbol	Parameter	Condition	Typ	Limit		Units
				Min	Max	
$\Delta V_{OUT\_LIN} / V_{OUT\_LIN(NOM)}$	Output Voltage Accuracy	In startup and normal mode		-1.5 -2.0	1.5 2.0	% %
$\Delta V_{OUT\_LIN} / \Delta V_{IN\_LIN}$	Line Regulation Error	$V_{IN\_LIN} = V_{OUT\_LIN(NOM)} + 0.3V$ to 4.5V, $V_{BATT} = 4.5V$	0.3		1	mV/V
$\Delta V_{OUT\_LIN} / \Delta V_{BATT}$		$V_{BATT} = V_{OUT\_LIN(NOM)} + 1.5V$ ( $\geq 2.7V$ ) to 5.5V	0.5		3.1	
$\Delta V_{OUT\_LIN} / \Delta mA$	Load Regulation Error	$I_{OUT\_LIN} = 1mA$ to 350mA	10		60	$\mu V/mA$
$V_{DO\_VIN\_LIN}$	Output Voltage Dropout <sup>(3)(4)</sup>	$I_{OUT\_LIN} = 350mA$ , $V_{BATT} = V_{OUT\_LIN(NOM)} + 1.5V$ ( $\geq 2.7V$ )	85		200	mV
		$I_{OUT\_LIN} = 150mA$ , $V_{BATT} = V_{OUT\_LIN(NOM)} + 1.3V$ ( $\geq 2.7V$ )	42		100	mV
$I_{Q\_VIN\_LIN}$	Quiescent Current into $V_{IN\_LIN}$	$I_{OUT\_LIN} = 0mA$	10		28	$\mu A$
	Shutdown Current into $V_{IN\_LIN}$	$V_{EN\_LIN} = 0V$	0.1		1	$\mu A$
$I_{SC\_LIN}$	Output Current (short circuit)	$V_{OUT\_LIN} = 0V$	500	350		mA
PSRR	Power Supply Rejection Ratio	Sine modulated $V_{BATT}$ , $f = 10Hz$ $f = 100Hz$ $f = 1kHz$	70 65 45			dB
		Sine modulated $V_{IN}$ $f = 10Hz$ $f = 100Hz$ $f = 1kHz$ $f = 10kHz$	80 90 95 85			dB
$E_N$	Output Noise linear regulator	10Hz - 100kHz	100			$\mu V_{RMS}$
$\Delta V_{OUT\_LIN}$	Dynamic line transient response $V_{IN\_LIN}$	$V_{IN\_LIN} = V_{OUT\_LIN(NOM)} + 0.3V$ to $V_{OUT\_LIN(NOM)} + 0.9V$ $t_r, t_f = 10\mu s$	$\pm 1$			mVp
	Dynamic line transient response $V_{BATT}$	$V_{BATT} = V_{OUT\_LIN(NOM)} + 1.5V$ to $V_{OUT\_LIN(NOM)} + 2.1V$ $t_r, t_f = 10\mu s$	$\pm 15$			mVp
$\Delta V_{OUT\_LIN}$	Dynamic load transient response	Pulsed load 0 ... 350mA $di/dt = 350mA/1\mu s$	$\pm 30$			mVp

- (1) All voltages are with respect to the potential at the SGND pin.  
(2) Min and Max limits are guaranteed by design, test, or statistical analysis. Typical numbers are not guaranteed, but do represent the most likely norm. Unless otherwise specified, conditions for typ. specifications are:  $V_{BATT} = 3.6V$  and  $T_A = 25^\circ C$ .  
(3) Dropout voltage is defined as the input to output voltage differential at which the output voltage falls to 100mV below the nominal output voltage.  
(4) This specification does not apply if the battery voltage  $V_{BATT}$  needs to be decreased below the minimum operating limit of 2.7V.

**Electrical Characteristics: Startup LDO<sup>(1)(2)</sup>**

Symbol	Parameter	Conditions	Typical	Limit		Units
				Min	Max	
$I_{OUT}$	Rated output current		50			mA
$I_{SC\_LIN}$	Output Current (short circuit)	$V_{OUT\_LIN} = 0V$	100	50		mA

- (1) All voltages are with respect to the potential at the SGND pin.  
(2) Min and Max limits are guaranteed by design, test, or statistical analysis. Typical numbers are not guaranteed, but do represent the most likely norm. Unless otherwise specified, conditions for typ. specifications are:  $V_{BATT} = 3.6V$  and  $T_A = 25^\circ C$ .

**Electrical Characteristics: System Parameters Supply<sup>(1)(2)</sup>**

Symbol	Parameter	Conditions	Typical	Limit		Units
				Min	Max	
I <sub>Q_VBATT</sub>	Quiescent current into V <sub>BATT</sub>	EN_LIN = low, EN_DCDC = high, I <sub>OUT_DCDC</sub> = I <sub>OUT_LIN</sub> = 0mA, DC-DC is not switching (FB_DCDC forced higher than V <sub>OUT_DCDC</sub> )	27		<b>60</b>	μA
		EN_LIN = high, EN_DCDC = low	55			μA
		EN_LIN = EN_DCDC = high	65			μA
	Shutdown current into V <sub>BATT</sub>	V <sub>EN_DCDC</sub> = V <sub>EN_LIN</sub> = 0V -30°C ≤ T <sub>J</sub> ≤ +85°C	0.1		<b>5</b>	μA

(1) All voltages are with respect to the potential at the SGND pin.

(2) Min and Max limits are guaranteed by design, test, or statistical analysis. Typical numbers are not guaranteed, but do represent the most likely norm. Unless otherwise specified, conditions for typ. specifications are: V<sub>BATT</sub> = 3.6V and T<sub>A</sub> = 25°C.

**Electrical Characteristics: Under-Voltage Protection<sup>(1)(2)</sup>**

Symbol	Parameter	Conditions	Typical	Limit		Units
				Min	Max	
V <sub>BATT_UVP</sub>	Under-Voltage Lockout		2.41			V
V <sub>BATT_EN</sub>	System Enable Voltage		2.65			V

(1) All voltages are with respect to the potential at the SGND pin.

(2) Min and Max limits are guaranteed by design, test, or statistical analysis. Typical numbers are not guaranteed, but do represent the most likely norm. Unless otherwise specified, conditions for typ. specifications are: V<sub>BATT</sub> = 3.6V and T<sub>A</sub> = 25°C.

**Electrical Characteristics: Enable Pins (EN\_DCDC, EN\_LIN)<sup>(1)(2)</sup>**

Symbol	Parameter	Conditions	Typical	Limit		Units
				Min	Max	
I <sub>EN</sub>	Enable pin input current		0.01		<b>1</b>	μA
V <sub>IH</sub>	Logic High voltage level			<b>1.0</b>		V
V <sub>IL</sub>	Logic Low voltage level				<b>0.4</b>	V

(1) All voltages are with respect to the potential at the SGND pin.

(2) Min and Max limits are guaranteed by design, test, or statistical analysis. Typical numbers are not guaranteed, but do represent the most likely norm. Unless otherwise specified, conditions for typ. specifications are: V<sub>BATT</sub> = 3.6V and T<sub>A</sub> = 25°C.

**Electrical Characteristics: Thermal Protection<sup>(1)(2)</sup>**

Symbol	Parameter	Conditions	Typical	Limit		Units
				Min	Max	
T <sub>SHDN</sub> <sup>(3)</sup>	Thermal-Shutdown Temperature		160			°C
ΔT <sub>SHDN</sub>	Thermal-Shutdown Hysteresis		20			°C

(1) All voltages are with respect to the potential at the SGND pin.

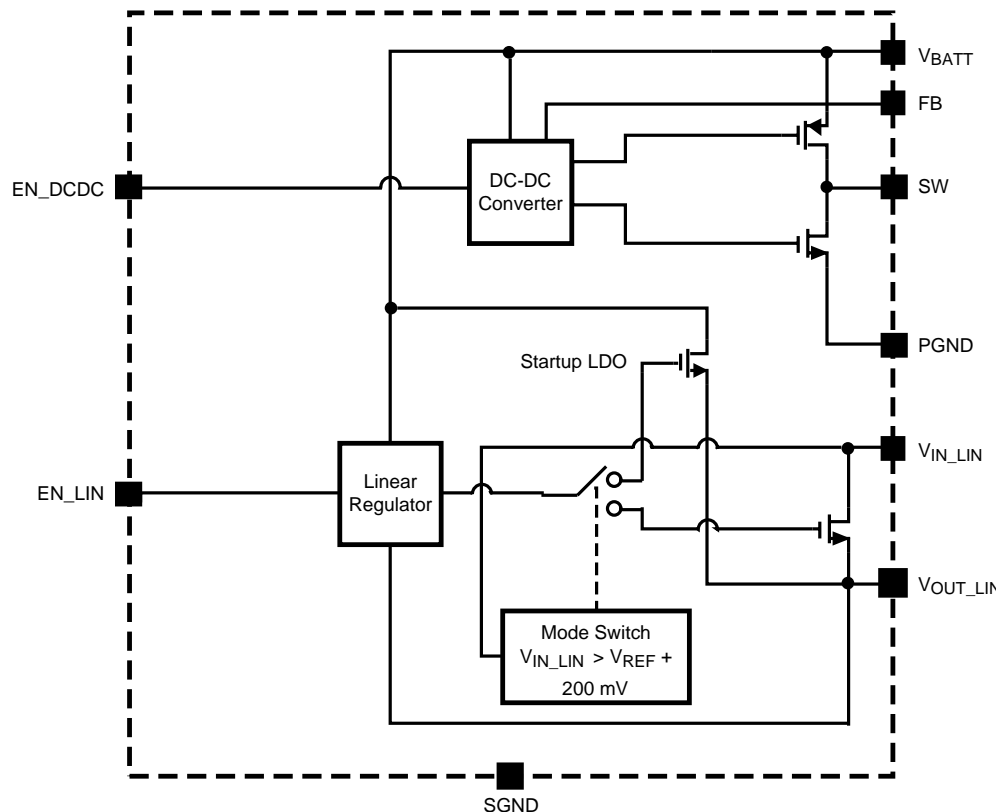
(2) Min and Max limits are guaranteed by design, test, or statistical analysis. Typical numbers are not guaranteed, but do represent the most likely norm. Unless otherwise specified, conditions for typ. specifications are: V<sub>BATT</sub> = 3.6V and T<sub>A</sub> = 25°C.

(3) The DC-DC converter will only enter thermal shutdown from PWM mode. At light loads -present for PFM mode- no significant contribution to the power dissipation is added by the DC-DC converter.

**Electrical Characteristics: External Components, Recommended Specification**<sup>(1)(2)(3)</sup>

Symbol	Parameter	Conditions	Value	Limit		Units
				Min	Max	
$C_{VOUT\_LIN}$	Output Capacitance for linear regulator		2.2	1.5	10	$\mu\text{F}$
$C_{VIN\_LIN}$	Input Capacitance for linear regulator	$V_{IN\_LIN}$ is biased separately, not by $V_{OUT\_DCDC}$ (no $C_{VIN\_LIN}$ needed for post regulation application)	1.0	0.47		$\mu\text{F}$
$C_{VBATT}$	Input Capacitance for DC-DC converter		4.7			$\mu\text{F}$
$C_{VOUT\_DCDC}$	DC-DC converter output filter capacitor		10			$\mu\text{F}$
$C_{ESR}$	ESR of all capacitors			0.003	0.300	$\Omega$
L	Inductance		2.2			$\mu\text{H}$
	$I_{SAT}$		1.6			A
	DCR				200	$\text{m}\Omega$

- (1) All voltages are with respect to the potential at the SGND pin.
- (2) Min and Max limits are guaranteed by design, test, or statistical analysis. Typical numbers are not guaranteed, but do represent the most likely norm. Unless otherwise specified, conditions for typ. specifications are:  $V_{BATT} = 3.6\text{V}$  and  $T_A = 25^\circ\text{C}$ .
- (3) The capacitor tolerance should be 30% or better over temperature. The full operating conditions for the application should be considered when selecting a suitable capacitor to ensure that the minimum value of capacitance is always met. Recommended capacitor type is X7R. However, dependent on application, X5R, Y5V, and Z5U can also be used. The shown minimum limit represents real minimum capacitance, including all tolerances and must be maintained over temperature and dc bias voltage (See [CAPACITOR CHARACTERISTICS](#))

**BLOCK DIAGRAM**

**Figure 4. Simplified Block Diagram**

### Typical Performance Characteristics

Unless otherwise specified, typical application (post regulation),  $V_{BATT} = 3.6V$ ,  $T_A = 25^\circ C$ , enable pins tied to  $V_{BATT}$ ,  $V_{OUT\_DCDC} = 1.8V$ ,  $V_{OUT\_LIN} = 1.2V$

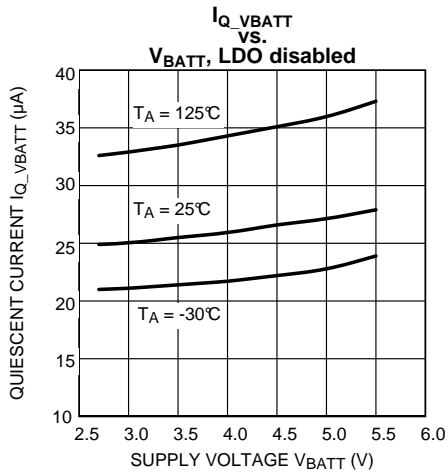


Figure 5.

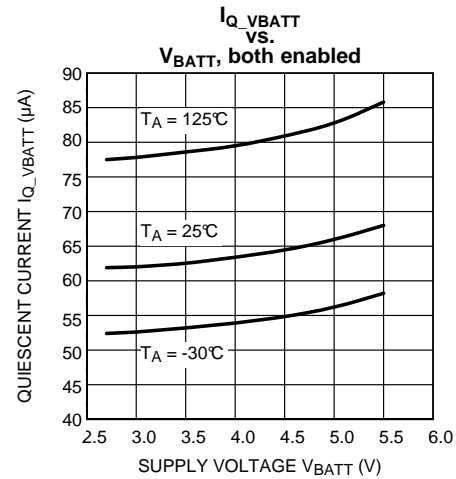


Figure 6.

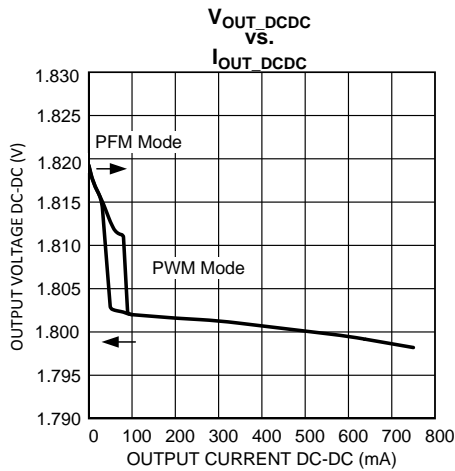


Figure 7.

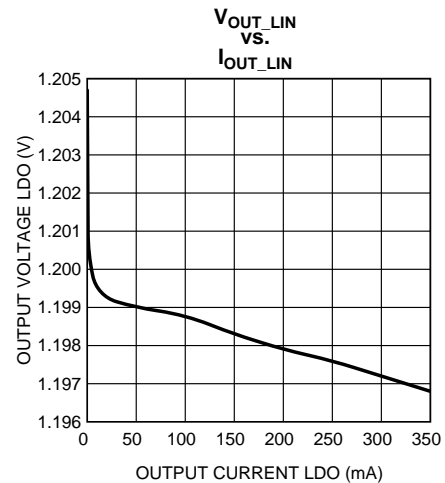


Figure 8.

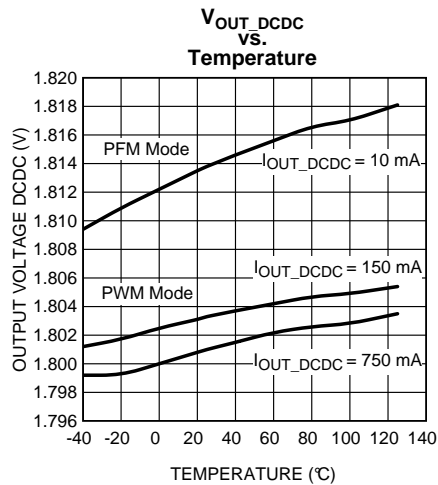


Figure 9.

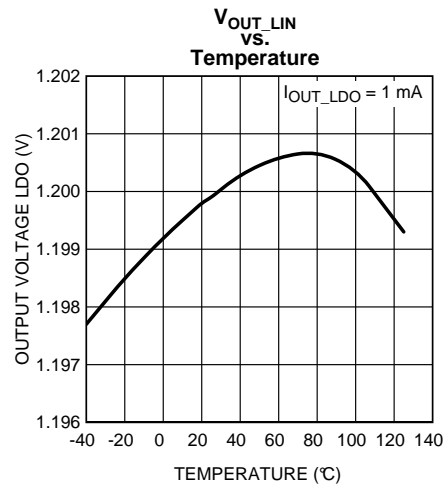


Figure 10.

### Typical Performance Characteristics (continued)

Unless otherwise specified, typical application (post regulation),  $V_{BATT} = 3.6V$ ,  $T_A = 25^\circ C$ , enable pins tied to  $V_{BATT}$ ,  $V_{OUT\_DCDC} = 1.8V$ ,  $V_{OUT\_LIN} = 1.2V$

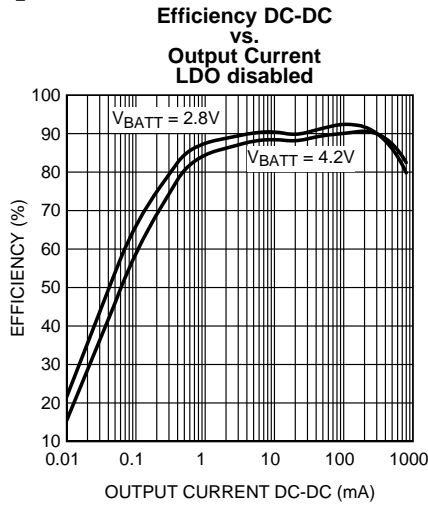


Figure 11.

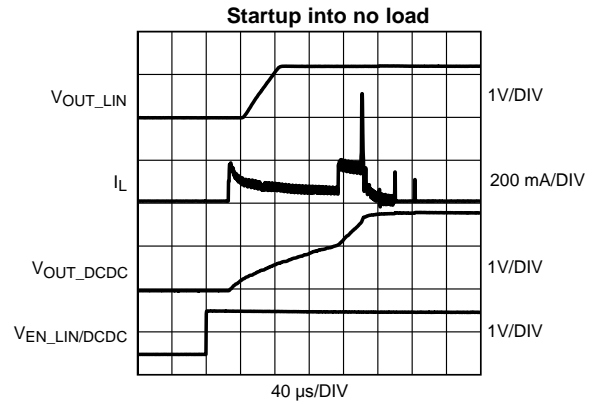


Figure 12.

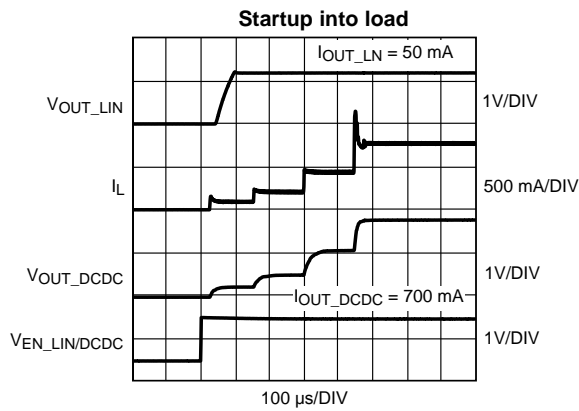


Figure 13.

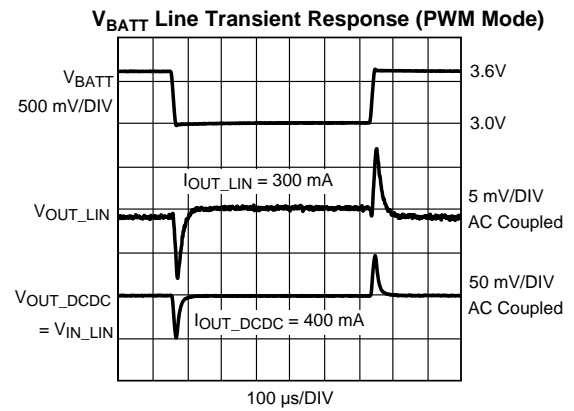


Figure 14.

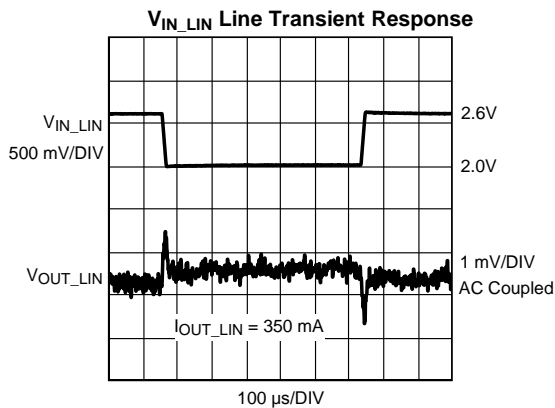


Figure 15.

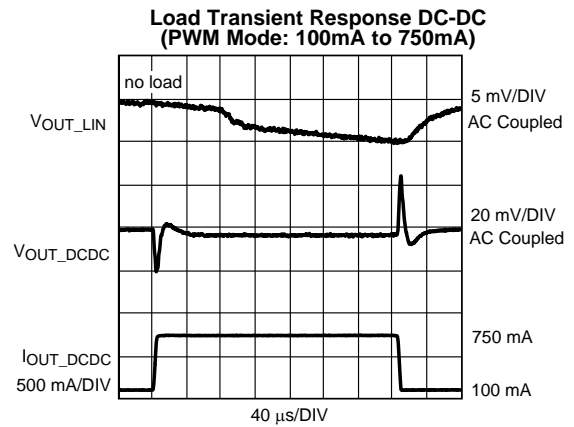


Figure 16.

### Typical Performance Characteristics (continued)

Unless otherwise specified, typical application (post regulation),  $V_{BATT} = 3.6V$ ,  $T_A = 25^\circ C$ , enable pins tied to  $V_{BATT}$ ,  $V_{OUT\_DCDC} = 1.8V$ ,  $V_{OUT\_LIN} = 1.2V$

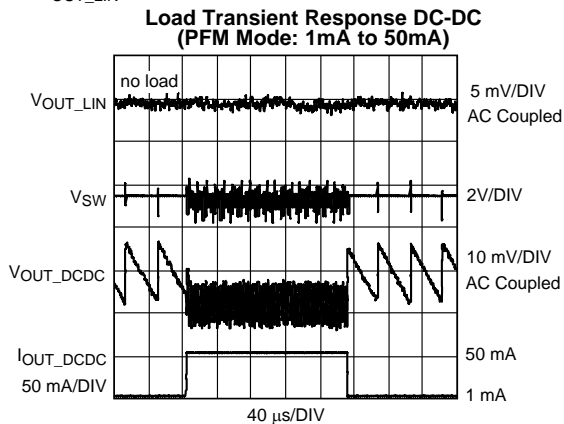


Figure 17.

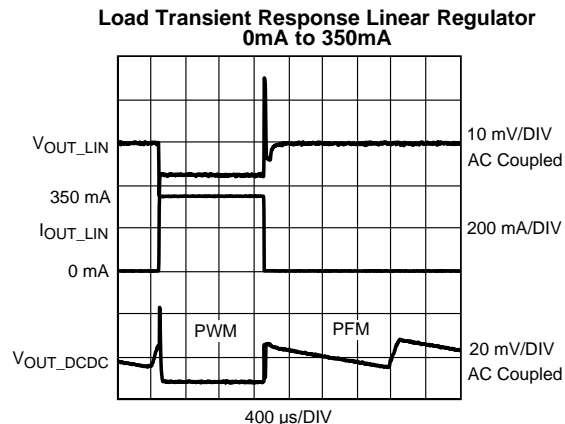


Figure 18.

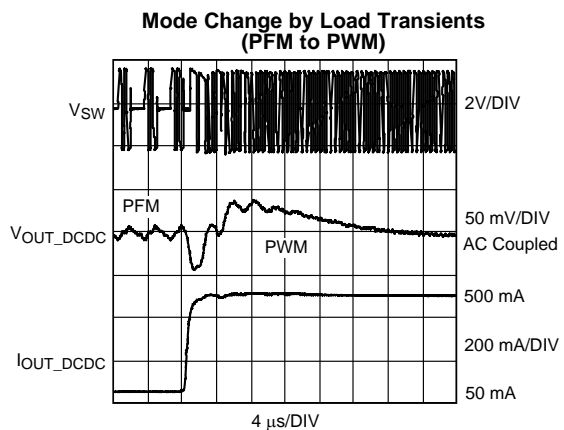


Figure 19.

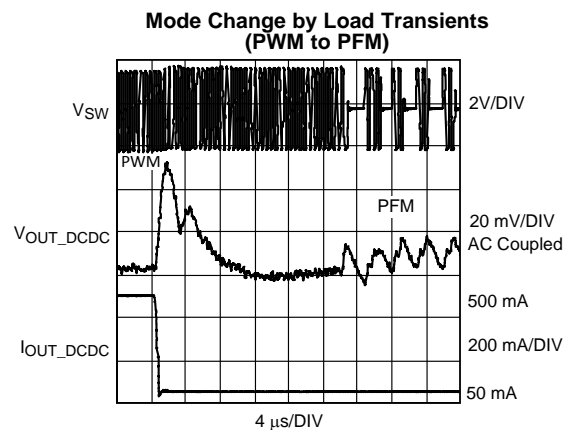


Figure 20.

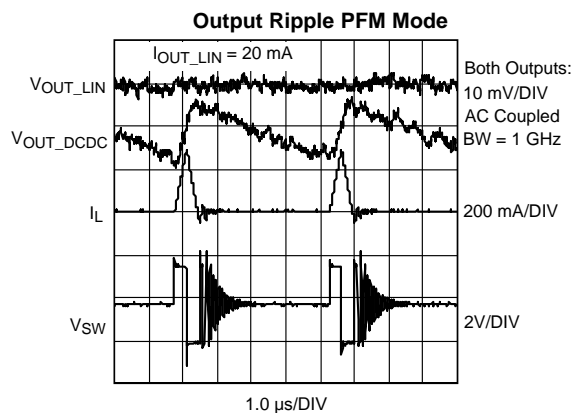


Figure 21.

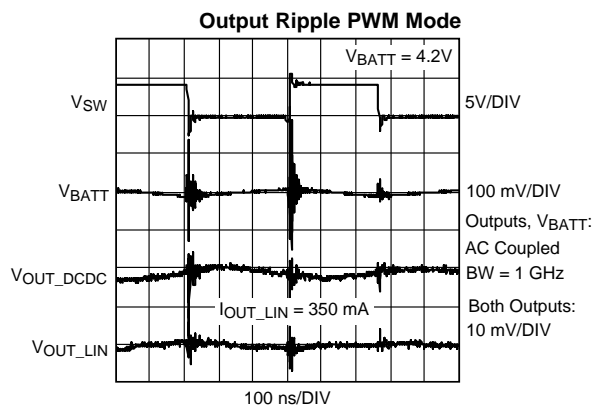


Figure 22.

## OPERATION DESCRIPTION

### DEVICE INFORMATION

The LM3687 incorporates a high efficiency synchronous switching step-down DC-DC converter and a very low dropout linear regulator.

The DC-DC converter delivers a constant voltage from a single Li-Ion battery and input voltage rails from 2.7V to 5.5V to portable devices such as cell phones and PDAs. Using a voltage mode architecture with synchronous rectification, it has the ability to deliver up to 750mA load current depending on the input voltage, output voltage, ambient temperature and the inductor chosen.

The linear regulator delivers a constant voltage biased from  $V_{IN\_LIN}$  power input - typically the output voltage of the DC-DC converter is used (post regulation) - with a maximum load current of 350mA.

Two enable pins allow the independent control of the two outputs. Shutdown mode turns off the device, offering the lowest current consumption ( $I_{SHUTDOWN} = 0.1 \mu A$  typ).

Besides the shutdown feature, for the DC-DC converter there are two more modes of operation depending on the current required:

- [PWM Operation](#), and
- [PFM Operation](#).

The device operates in PWM mode at load current of approximately 80 mA or higher. Lighter load currents cause the device to automatically switch into PFM for reduced current consumption ( $I_{Q\_VBATT} = 27 \mu A$  typ) and a longer battery life.

Additional features include soft-start, startup mode of the linear regulator, under-voltage protection, current overload protection, and over-temperature protection.

As shown in [Typical Application Circuit](#), only four external surface-mount components are required for implementation - one inductor and three ceramic capacitors.

An internal reference generates 1.8V biasing an internal resistive divider to create a reference voltage range from 0.45V to 1.8V (in 50mV steps) for the linear regulator (depending on the output voltage setting defined in the fab) and the 0.5V reference used for the DC-DC converter.

The Under-voltage lockout feature enables the device to startup once  $V_{BATT}$  has reached 2.65V typically and turns the device off if  $V_{BATT}$  drops below 2.41V typically.

---

#### NOTE

In the case that the DC-DC converter is switched off while the Linear Regulator is still enabled, an overshoot of up to 150mV might appear at  $V_{OUT\_LIN}$ , if all of the following conditions are present:

- high  $V_{BATT}$
  - down ramp on  $V_{IN\_LIN}$  of greater than 100mV/16us taking the Linear Regulator into dropout
  - light load on Linear Regulator
- 

### DC-DC CONVERTER OPERATION

During the first part of each switching cycle, the control block in the LM3687 turns on the internal PFET switch. This allows current to flow from the input  $V_{BATT}$  through the switch pin SW and the inductor to the output filter capacitor and load. The inductor limits the current to a ramp with a slope of  $(V_{BATT} - V_{OUT\_DCDC}) / L$ , by storing energy in the magnetic field.

During the second part of each cycle, the controller turns the PFET switch off, blocking current flow from the input, and then turns the NFET synchronous rectifier on. The inductor draws current from ground through the NFET to the output filter capacitor and load, which ramps the inductor current down with a slope of  $(-V_{OUT\_DCDC} / L)$ .

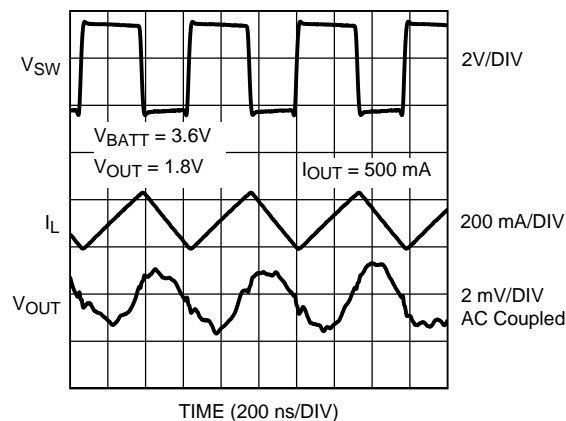
The output filter stores charge when the inductor current is high, and releases it when low, smoothing the voltage across the load.

The output voltage is regulated by modulating the PFET switch on time to control the average current sent to the load. The effect is identical to sending a duty-cycle modulated rectangular wave formed by the switch and synchronous rectifier at the SW pin to a low-pass filter formed by the inductor and output filter capacitor. The output voltage is equal to the average voltage at the SW pin.

### PWM Operation

During PWM (Pulse Width Modulation) operation the converter operates as a voltage-mode controller with input voltage feed forward. This allows the converter to achieve good load and line regulation. The DC gain of the power stage is proportional to the input voltage. To eliminate this dependency, feed forward inversely proportional to the input voltage is introduced.

While in PWM mode, the output voltage is regulated by switching at a constant frequency and then modulating the energy per cycle to control power to the load. At the beginning of each clock cycle the PFET switch is turned on and the inductor current ramps up until the duty-cycle-comparator trips and the control logic turns off the switch. The current limit comparator can also turn off the switch in case the current limit of the PFET is exceeded. Then the NFET switch is turned on and the inductor current ramps down. The next cycle is initiated by the clock turning off the NFET and turning on the PFET.



**Figure 23. Typical PWM Operation**

### Internal Synchronous Rectification

While in PWM mode, the DC-DC converter uses an internal NFET as a synchronous rectifier to reduce rectifier forward voltage drop and associated power loss. Synchronous rectification provides a significant improvement in efficiency whenever the output voltage is relatively low compared to the voltage drop across an ordinary rectifier diode.

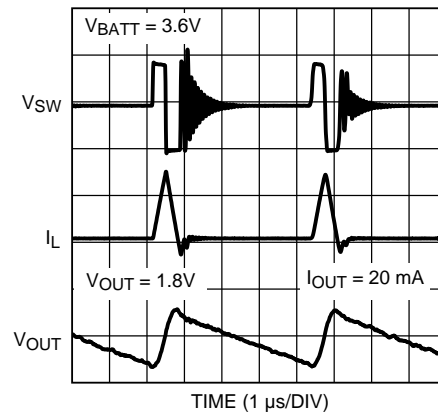
### Current Limiting

A current limit feature allows the LM3687 to protect itself and external components during overload conditions. PWM mode implements current limiting using an internal comparator that trips at 1172 mA (typ). If the output is shorted to ground the device enters a timed current limit mode where the NFET is turned on for a longer duration until the inductor current falls below a low threshold. This allows the inductor current more time to decay, thereby preventing runaway.

### PFM Operation

At very light load, the DC-DC converter enters PFM mode and operates with reduced switching frequency and supply current to maintain high efficiency. The part automatically transitions into PFM mode when either of two conditions occurs for a duration of 32 or more clock cycles:

- The NFET current reaches zero.
- The peak PMOS switch current drops below the  $I_{MODE}$  level, (typically  $I_{MODE} < 36\text{ mA} + V_{BATT} / 35\ \Omega$ ).



**Figure 24. Typical PFM Operation**

During PFM operation, the DC-DC converter positions the output voltage slightly higher than the nominal output voltage during PWM operation, allowing additional headroom for voltage drop during a load transient from light to heavy load. The PFM comparators sense the output voltage via the feedback pin and control the switching of the output FETs such that the output voltage ramps between  $\sim 0.6\%$  and  $\sim 1.7\%$  above the nominal PWM output voltage. If the output voltage is below the 'high' PFM comparator threshold, the PMOS power switch is turned on. It remains on until the output voltage reaches the 'high' PFM threshold or the peak current exceeds the  $I_{PFM}$  level set for PFM mode. The typical peak current in PFM mode is:  $I_{PFM} = 134\text{mA} + V_{BATT} / 23\Omega$ .

Once the PMOS power switch is turned off, the NMOS power switch is turned on until the inductor current ramps to zero. When the NMOS zero-current condition is detected, the NMOS power switch is turned off. If the output voltage is below the 'high' PFM comparator threshold (see [Figure 25](#)), the PMOS switch is again turned on and the cycle is repeated until the output reaches the desired level. Once the output reaches the 'high' PFM threshold, the NMOS switch is turned on briefly to ramp the inductor current to zero and then both output switches are turned off and the part enters an extremely low power mode. Quiescent supply current during this 'sleep' mode is  $27\mu\text{A}$  (typ), which allows the part to achieve high efficiency under extremely light load conditions.

If the load current should increase during PFM mode (see [Figure 25](#)) causing the output voltage to fall below the 'low2' PFM threshold, the part will automatically transition into fixed-frequency PWM mode.

When  $V_{BATT} = 2.7V$  the part transitions from PWM to PFM mode at  $\sim 30\text{mA}$  output current and from PFM to PWM mode at  $\sim 80\text{mA}$ , when  $V_{BATT} = 3.6V$ , PWM to PFM transition happens at  $\sim 60\text{mA}$  and PFM to PWM transition happens at  $\sim 90\text{mA}$ , when  $V_{BATT} = 5.5V$ , PWM to PFM transition happens at  $\sim 100\text{mA}$  and PFM to PWM transition happens at  $\sim 125\text{mA}$ .

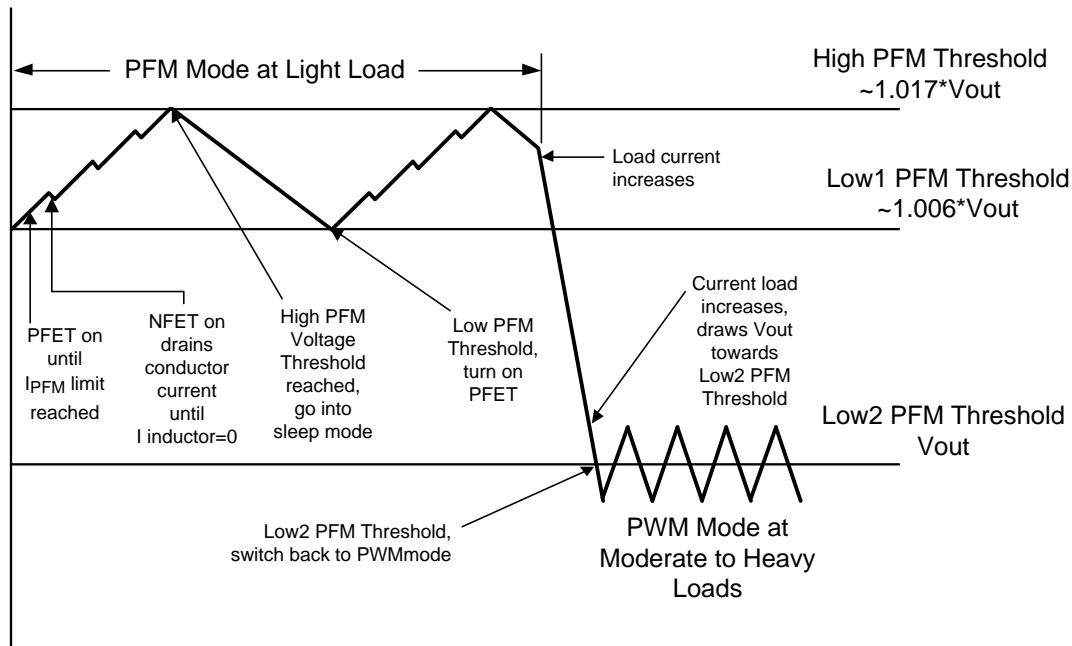


Figure 25. Operation in PFM Mode and Transfer to PWM Mode

### Soft Start

The DC-DC converter has a soft-start circuit that limits in-rush current during start-up. During start-up the switch current limit is increased in steps. Soft start is activated only if EN\_DCDC goes from logic low to logic high after  $V_{BATT}$  reaches 2.7V. Soft start is implemented by increasing switch current limit in steps of 85mA, 170mA, 340mA and 1120mA (typical switch current limit). The start-up time thereby depends on the output capacitor and load current demanded at start-up. Typical start-up times with a 10 $\mu$ F output capacitor and 750mA load is 455  $\mu$ s and with 1mA load is 180 $\mu$ s.

### LINEAR REGULATOR OPERATION

In the typical post regulation application the power input voltage  $V_{IN\_LIN}$  for the linear regulator is generated by the DC-DC converter. Using a buck converter to reduce the battery voltage to a lower input voltage for the linear regulator translates to higher efficiency and lower power dissipation.

It's also possible to operate the linear regulator independent of the DC-DC converter output voltage either from  $V_{BATT}$  or a different source. In this case it's important that  $V_{IN\_LIN}$  **does not exceed  $V_{BATT}$  at any time**.  $V_{BATT}$  is needed for the linear regulator as well, it supplies internal circuitry.

An input capacitor of 1 $\mu$ F at  $V_{IN\_LIN}$  needs to be added if no other filter or bypass capacitor is present in the  $V_{IN\_LIN}$  path.

### Startup Mode

If the linear regulator is enabled (logic high at EN\_LIN), the power input voltage  $V_{IN\_LIN}$  is continuously compared to the nominal output voltage of the linear regulator  $V_{OUT\_LIN}$ .

If  $V_{IN\_LIN} > V_{OUT\_LIN(NOM)} + 200\text{mV}$  the main regulator is active, offering a rated output current of 350mA and supplied by  $V_{IN\_LIN}$ .

If  $V_{IN\_LIN} < V_{OUT\_LIN(NOM)} + 100\text{mV}$  the startup LDO is active, providing a reduced rated output current of 50mA typical, supplied by  $V_{BATT}$ . Between these two levels a hysteresis of 100mV is established. This feature is intended to enable the supply of loads at the output of the linear regulator while the output of the DC-DC converter is still ramping up.

In the typical post regulation application with both enable pins connected to  $V_{BATT}$  and  $V_{IN\_LIN}$  supplied by  $V_{OUT\_DCDC}$  as an example, the linear regulator turns on in startup mode ( $I_{MAX} = 50\text{mA}$ ) supplied out of  $V_{BATT}$ . At the same time the DC-DC converter turns on, but  $V_{OUT\_DCDC}$  startup time is longer. The internal signal 'Mode Switch' monitors the voltage level of  $V_{IN\_LIN}$ . Once  $V_{IN\_LIN} > V_{OUT\_LIN(NOM)} + 200\text{mV}$ , the linear regulator changes to normal mode ( $I_{MAX} = 350\text{mA}$ ) supplied out of  $V_{IN\_LIN}$ . If  $V_{IN\_LIN}$  drops below  $V_{OUT\_LIN(NOM)} + 100\text{mV}$  the linear regulator switches back to startup mode.

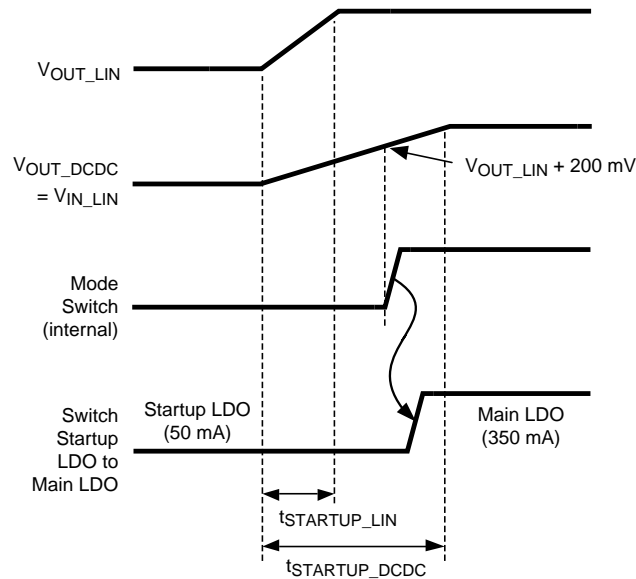


Figure 26. Startup Sequence,  $V_{EN\_DCDC} = V_{EN\_LIN} = V_{BATT}$

## Current Limiting

The LM3687 incorporates also a current limit feature for the linear regulator to protect itself and external components during overload conditions at  $V_{OUT\_LIN}$ . In the event of a peak over-current condition at  $V_{OUT\_LIN}$  the output current through the NFET pass device will be limited.

## Application Hints

### INDUCTOR SELECTION

There are two main considerations when choosing an inductor; the inductor should not saturate, and the inductor current ripple should be small enough to achieve the desired output voltage ripple. Different saturation current rating specifications are followed by different manufacturers so attention must be given to details. Saturation current ratings are typically specified at 25°C. However, ratings at the maximum ambient temperature of application should be requested from the manufacturer. **The minimum value of inductance to guarantee good performance is 1.76µH at  $I_{LIM}$  (typ) dc current over the ambient temperature range.** Shielded inductors radiate less noise and should be preferred. There are two methods to choose the inductor saturation current rating.

#### Method 1

The saturation current should be greater than the sum of the maximum load current and the worst case average to peak inductor current. This can be written as:

$$I_{SAT} > I_{OUT\_DCDC\_MAX} + I_{RIPPLE} \quad (1)$$

where

$$I_{SAT} > I_{OUTMAX} + I_{RIPPLE}$$

$$\text{where } I_{RIPPLE} = \left( \frac{V_{BATT} - V_{OUT}}{2 \times L} \right) \times \left( \frac{V_{OUT}}{V_{BATT}} \right) \times \left( \frac{1}{f} \right)$$

where

- $I_{RIPPLE}$ : average to peak inductor current
- $I_{OUT\_DCDCMAX}$ : maximum load current (750mA)
- $V_{BATT}$ : maximum input voltage in application
- L: minimum inductor value including worst case tolerances (30% drop can be considered for method 1)
- f: minimum switching frequency (1.3MHz) (2)

### Method 2

A more conservative and recommended approach is to choose an inductor that has a saturation current rating greater than the maximum current limit of 1380mA.

A 2.2  $\mu$ H inductor with a saturation current rating of at least 1380mA is recommended for most applications. The inductor's resistance should be less than 0.3 $\Omega$  for good efficiency. Table 1 lists suggested inductors and suppliers. For low-cost applications, an unshielded bobbin inductor could be considered. For noise critical applications, a toroidal or shielded- bobbin inductor should be used. A good practice is to lay out the board with overlapping footprints of both types for design flexibility. This allows substitution of a low-noise shielded inductor, in the event that noise from low-cost bobbin models is unacceptable.

**Table 1. Suggested Inductors and their Suppliers**

Model	Vendor	Dimensions LxWxH (mm)	DCR (max)
NR3015T2R2M	Taiyo Yuden	3.0 x 3.0 x 1.5	72m $\Omega$
LPS3015-222ML	Coilcraft	3.0 x 3.0 x 1.5	110m $\Omega$
DO3314-222MX	Coilcraft	3.3 x 3.3 x 1.4	200m $\Omega$

### EXTERNAL CAPACITORS

As is common with most regulators, the LM3687 requires external capacitors to ensure stable operation. The LM3687 is specifically designed for portable applications requiring minimum board space and the smallest size components. These capacitors must be correctly selected for good performance.

### INPUT CAPACITOR SELECTION

$V_{BATT}$

A ceramic input capacitor of 4.7  $\mu$ F, 6.3V is sufficient for most applications. Place the input capacitor as close as possible to the  $V_{BATT}$  pin of the device. A larger value may be used for improved input voltage filtering. Use X7R or X5R types; do not use Y5V. DC bias characteristics of ceramic capacitors must be considered when selecting case sizes like 0805 and 0603. The minimum input capacitance to guarantee good performance is 2.2 $\mu$ F at 3V dc bias; 1.5 $\mu$ F at 5V dc bias including tolerances and over ambient temperature range. The input filter capacitor supplies current to the PFET switch of the LM3687 DC-DC converter in the first half of each cycle and reduces voltage ripple imposed on the input power source. A ceramic capacitor's low ESR provides the best noise filtering of the input voltage spikes due to this rapidly changing current. Select a capacitor with sufficient ripple current rating. The input current ripple can be calculated as:

$$I_{RMS} = I_{OUTMAX} \times \sqrt{\frac{V_{OUT}}{V_{BATT}} \times \left(1 - \frac{V_{OUT}}{V_{BATT}} + \frac{r^2}{12}\right)}$$

$$r = \frac{(V_{BATT} - V_{OUT}) \times V_{OUT}}{L \times f \times I_{OUTMAX} \times V_{BATT}}$$

The worst case is when  $V_{BATT} = 2 \times V_{OUT}$  (3)

### $V_{IN\_LIN}$

If the linear regulator is used as post regulation no additional capacitor is needed at  $V_{IN\_LIN}$  as the output filter capacitor of the DC-DC converter is close by and therefore sufficient.

In case of independent use, a 1.0µF ceramic capacitor is recommended at  $V_{IN\_LIN}$  if no other filter capacitor is present in the  $V_{IN\_LIN}$  supply path. This capacitor must be located a distance of not more than 1 cm from the  $V_{IN\_LIN}$  input pin and returned to a clean analogue ground. Any good quality ceramic, tantalum, or film capacitor may be used at this input.

### Important

Tantalum capacitors can suffer catastrophic failures due to surge current when connected to a low-impedance source of power (like a battery or a very large capacitor). If a tantalum capacitor is used at this input, it must be guaranteed by the manufacturer to have a surge current rating sufficient for the application.

The ESR (Equivalent Series Resistance) of this input capacitor should be in the range of 3mΩ to 300mΩ. The tolerance and temperature coefficient must be considered when selecting the capacitor to ensure the capacitance will remain ≥ 470nF over the entire operating temperature range.

## OUTPUT CAPACITOR

### $V_{OUT\_DCDC}$

A ceramic output capacitor of 10 µF, 6.3V is sufficient for most applications. Use X7R or X5R types; do not use Y5V. DC bias characteristics of ceramic capacitors must be considered when selecting case sizes like 0805 and 0603. DC bias characteristics vary from manufacturer to manufacturer and dc bias curves should be requested from them as part of the capacitor selection process.

**The minimum output capacitance to guarantee good performance is 5.75µF at 1.8V DC bias including tolerances and over ambient temperature range.** The output filter capacitor smoothes out current flow from the inductor to the load, helps maintain a steady output voltage during transient load changes and reduces output voltage ripple. These capacitors must be selected with sufficient capacitance and sufficiently low ESR to perform these functions.

The output voltage ripple is caused by the charging and discharging of the output capacitor and by the  $R_{ESR}$  and can be calculated as:

Voltage peak-to-peak ripple due to capacitance can be expressed as follow:

$$V_{PP-C} = \frac{I_{RIPPLE}}{4 \times f \times C} \quad (4)$$

Voltage peak-to-peak ripple due to ESR can be expressed as follow:

$$V_{PP-ESR} = (2 \times I_{RIPPLE}) \times R_{ESR}$$

Because these two components are out of phase, the rms (root mean squared) value can be used to get an approximate value of peak-to-peak ripple. The peak-to-peak ripple voltage, rms value can be expressed as follow:

$$V_{PP-RMS} = \sqrt{V_{PP-C}^2 + V_{PP-ESR}^2} \quad (5)$$

Note that the output voltage ripple is dependent on the inductor current ripple and the equivalent series resistance of the output capacitor ( $R_{ESR}$ ). The  $R_{ESR}$  is frequency dependent (as well as temperature dependent); make sure the value used for calculations is at the switching frequency of the part.

$V_{OUT\_LIN}$

The linear regulator is designed specifically to work with very small ceramic output capacitors. A ceramic capacitor (dielectric types X7R, Z5U, or Y5V) in the 2.2 $\mu$ F range (up to 10 $\mu$ F) and with an ESR between 3m $\Omega$  to 300m $\Omega$  is suitable as  $C_{OUT\_LIN}$  in the LM3687 application circuit.

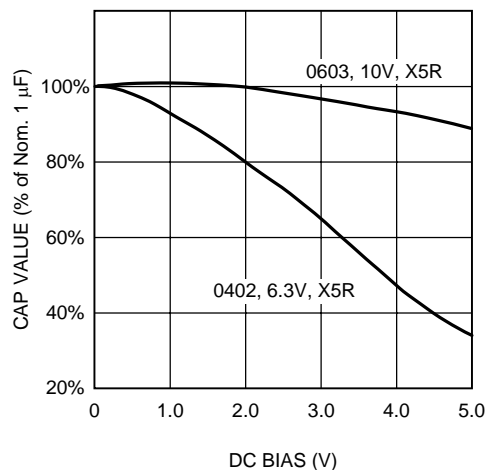
This capacitor must be located a distance of not more than 1cm from the  $V_{OUT\_LIN}$  pin and returned to a clean analogue ground. It is also possible to use tantalum or film capacitors at the device output,  $V_{OUT\_LIN}$ , but these are not as attractive for reasons of size and cost (see [CAPACITOR CHARACTERISTICS](#)).

**CAPACITOR CHARACTERISTICS**

The LM3687 is designed to work with ceramic capacitors on the outputs to take advantage of the benefits they offer. For capacitance values in the range of 1 $\mu$ F to 4.7 $\mu$ F, ceramic capacitors are the smallest, least expensive and have the lowest ESR values, thus making them best for eliminating high frequency noise. The ESR of a typical 1 $\mu$ F ceramic capacitor is in the range of 3m $\Omega$  to 40m $\Omega$ , which easily meets the ESR requirement for stability for the LM3687.

For both input and output capacitors, careful interpretation of the capacitor specification is required to ensure correct device operation. The capacitor value can change greatly, depending on the operating conditions and capacitor type.

In particular, the output capacitor selection should take account of all the capacitor parameters, to ensure that the specification is met within the application. The capacitance can vary with DC bias conditions as well as temperature and frequency of operation. Capacitor values will also show some decrease over time due to aging. The capacitor parameters are also dependant on the particular case size, with smaller sizes giving poorer performance figures in general. As an example, the graph below shows a comparison of different capacitor case sizes in a Capacitance vs. DC Bias plot. As shown in the graph, increasing the DC Bias condition can result in the capacitance value falling below the minimum recommended value. It is therefore recommended that the capacitor manufacturers' specifications for the nominal value capacitor are consulted for all conditions, as some capacitor sizes (e.g. 0402) may not be suitable in the actual application.



**Figure 27. Graph Showing a Typical Variation In Capacitance vs. DC Bias**

The ceramic capacitor's capacitance can vary with temperature. The capacitor type X7R, which operates over a temperature range of -55 $^{\circ}$ C to +125 $^{\circ}$ C, will only vary the capacitance to within  $\pm$ 15%. The capacitor type X5R has a similar tolerance over a reduced temperature range of -55 $^{\circ}$ C to +85 $^{\circ}$ C. Many large value ceramic capacitors, larger than 1 $\mu$ F are manufactured with Z5U or Y5V temperature characteristics. Their capacitance can drop by more than 50% as the temperature varies from 25 $^{\circ}$ C to 85 $^{\circ}$ C. Therefore X7R is recommended over Z5U and Y5V in applications where the ambient temperature will change significantly above or below 25 $^{\circ}$ C.

Tantalum capacitors are less desirable than ceramic for use as output capacitors because they are more expensive when comparing equivalent capacitance and voltage ratings in the 1 $\mu$ F to 4.7 $\mu$ F range.

Another important consideration is that tantalum capacitors have higher ESR values than equivalent size ceramics. This means that while it may be possible to find a tantalum capacitor with an ESR value within the stable range, it would have to be larger in capacitance (which means bigger and more costly) than a ceramic capacitor with the same ESR value. It should also be noted that the ESR of a typical tantalum will increase about 2:1 as the temperature goes from 25°C down to -40°C, so some guard band must be allowed. For the output capacitor of the DC-DC converter, please note that the output voltage ripple is dependent on the ESR of the output capacitor.

**Table 2. Suggested Capacitors and their Suppliers**

Capacitance / $\mu$ F	Model	Voltage Rating	Vendor	Type	Case Size / Inch (mm)
10.0	C1608X5R0J106K	6.3V	TDK	Ceramic, X5R	0603 (1608)
4.7	C1608X5R1A475K	10V	TDK	Ceramic, X5R	0603 (1608)
2.2	C1608X5R1A225K	10V	TDK	Ceramic, X5R	0603 (1608)
1.0	C1005X5R1A105K	10V	TDK	Ceramic, X5R	0402 (1005)

## POWER DISSIPATION AND DEVICE OPERATION

The permissible power dissipation for any package is a measure of the capability of the device to pass heat from the power source, the junctions of the IC, to the ultimate heat sink, the ambient environment. Thus the power dissipation is dependent on the ambient temperature and the thermal resistance across the various interfaces between the die and ambient air.

As stated in [Operating Ratings](#), the allowable power dissipation for the device in a given package can be calculated using the equation:

$$P_{D\_SYS} = (T_{J(MAX)} - T_A) / \theta_{JA} \quad (6)$$

For the LM3687 there are two different main sources contributing to the systems power dissipation ( $P_{D\_SYS}$ ): the DC-DC converter ( $P_{D\_DCDC}$ ) and the linear regulator ( $P_{D\_LIN}$ ). Neglecting switching losses and quiescent currents these two main contributors can be estimated by the following equations:

$$P_{D\_LIN} = (V_{IN\_LIN} - V_{OUT\_LIN}) * I_{OUT\_LIN} \quad (7)$$

$$P_{D\_DCDC} = I_{OUT\_DCDC}^2 * [(R_{DS(on)(P)} * D) + (R_{DS(on)(N)} * (1-D))]$$

where

- duty cycle  $D = V_{OUT\_DCDC} / V_{BATT}$ . (8)

As an example, assuming the typical post regulation application, the conversion from  $V_{BATT} = 3.6V$  to  $V_{OUT\_DCDC} = 1.8V$  and further to  $V_{OUT\_LIN} = 1.5V$ , at maximum load currents, results in following power dissipations:

$$P_{D\_DCDC} = (0.75A)^2 * (0.38\Omega * 1.8V / 3.6V + 0.25\Omega * (1 - 1.8V / 3.6V)) = 177mW \text{ and}$$

$$P_{D\_LIN} = (1.8V - 1.5V) * 0.35A = 105mW.$$

$$P_{D\_SYS} = 282mW.$$

With a  $\theta_{JA} = 70^\circ C/W$  for the DSBGA 9 package this  $P_{D\_SYS}$  will cause a rise of the junction temperature  $T_J$  of:

$$\Delta T_J = P_{D\_SYS} * \theta_{JA} = 20K.$$

For the same conditions but the linear regulator biased from  $V_{BATT}$ , this results in a  $P_{D\_LIN}$  of 735mW,  $P_{D\_DCDC} = 50mW$  (because  $I_{OUT\_DCDC} = 400mA$ ) and therefore an increase of  $T_J$  of 55K.

As lower total power dissipation translates to higher efficiency this example highlights the advantage of the post regulation setup.

## NO-LOAD STABILITY

Both outputs of the LM3687 will remain stable and in regulation with no external load. This is an important consideration in some circuits, for example CMOS RAM keep-alive applications.

## ENABLE OPERATION

The outputs of LM3687 may be switched ON or OFF by a logic input at the Enable pins,  $V_{EN\_DCDC}$  and  $V_{EN\_LIN}$ . A logic high (related to  $V_{BATT}$ ) at these pins will turn the outputs on (for information on startup sequence please refer to [Operation Description](#)).

When both enable pins are low, the outputs are off (pins SW and  $V_{OUT\_LIN}$  are high impedance) and the device typically consumes 0.1 $\mu$ A.

If the application does not require the Enable switching feature, the enable pins should be tied to  $V_{BATT}$  to keep the outputs permanently on.

To ensure proper operation, the signal source used to drive the enable inputs must be able to swing above and below the specified turn-on/off voltage thresholds listed in [Electrical Characteristics: Enable Pins \(EN\\_DCDC, EN\\_LIN\)](#),  $V_{IL}$  and  $V_{IH}$ .

## FAST TURN ON

For  $V_{OUT\_LIN}$  fast turn-on is guaranteed by an optimized architecture allowing a fast ramp of the output voltage to reach the target voltage while the inrush current is controlled low at 120mA typical (for a  $C_{OUT}$  of 2.2 $\mu$ F; assuming  $V_{IN\_LIN}$  is settled before enable happens).

## SHORT-CIRCUIT PROTECTION

Both outputs of the LM3687 are short circuit protected and in the event of a peak over-current condition, the output current through the MOS transistors will be limited.

If the over-current condition exists for a longer time, the average power dissipation will increase depending on the input to output voltage differences until the thermal shutdown circuitry will turn off the MOS transistors.

Please refer to [POWER DISSIPATION AND DEVICE OPERATION](#) for calculations.

## THERMAL-OVERLOAD PROTECTION

Thermal-Overload Protection limits the total power dissipation in the LM3687. When the junction temperature exceeds  $T_J = 160^\circ\text{C}$  typ., the shutdown logic is triggered and the output MOS transistors are turned off, allowing the device to cool down. After the junction temperature dropped by  $20^\circ\text{C}$  (temperature hysteresis), the output MOS transistors are activated again. This results in a pulsed output voltage during continuous thermal-overload conditions.

As the DC-DC converter in PFM mode (low load current) does not contribute significantly to an increase of  $T_J$ , it is not turned off in case a thermal shutdown is initiated. If the DC-DC converter operates in PWM mode, the PMOS is turned off in case of a thermal shutdown.

The Thermal-Overload Protection is designed to protect the LM3687 in the event of a fault condition. For normal, continuous operation, do not exceed the absolute maximum junction temperature rating of  $T_J = +150^\circ\text{C}$  (see [Absolute Maximum Ratings](#)).

## REVERSE CURRENT PATH

There are two body diodes at the switch pin of the DC-DC converter. It is not allowed to pull the switch pin above  $V_{BATT}$  or below PGND by more than 200mV.

On the main linear regulator there is a bulk switching feature in place preventing the parasitic diode structures from conducting current. This feature is only active as long as any of the regulators is enabled.

For the startup LDO,  $V_{OUT\_LIN}$  must not exceed  $V_{BATT}$ .

## EVALUATION BOARDS

For availability of evaluation boards please refer to the Product Folder of LM3687 at [www.national.com](http://www.national.com). For information regarding evaluation boards, please refer to Application Note: AN-1647.

## DSBGA PACKAGE ASSEMBLY AND USE

Use of the DSBGA package requires specialized board layout, precision mounting and careful re-flow techniques, as detailed in Application Note 1112. Refer to the section "Surface Mount Assembly Considerations". For best results in assembly, alignment ordinals on the PC board should be used to facilitate placement of the device. The pad style used with DSBGA package must be the NSMD (non-solder mask defined) type. This means that the solder-mask opening is larger than the pad size. This prevents a lip that otherwise forms if the soldermask and pad overlap, from holding the device off the surface of the board and interfering with mounting. See Application Note 1112 for specific instructions how to do this. The 9-Bump package used for LM3687 has 300 micron solder balls and requires 275 micron pads for mounting on the circuit board. The trace to each pad should enter the pad with a 90° entry angle to prevent debris from being caught in deep corners. Initially, the trace to each pad should not exceed 183 micron, for a section approximately 183 micron long or longer, as a thermal relief. Then each trace should neck up or down to its optimal width. The important criteria is symmetry. This ensures the solder bumps on the LM3687 re-flow evenly and that the device solders level to the board. In particular, special attention must be paid to the pads for bumps A1, A2, C1 and B3, because PGND, SGND,  $V_{BATT}$  and  $V_{IN\_LIN}$  are typically connected to large copper planes, inadequate thermal relief can result in late or inadequate re-flow of these bumps. The DSBGA package is optimized for the smallest possible size in applications with red or infrared opaque cases. Because the DSBGA package lacks the plastic encapsulation characteristic of larger devices, it is vulnerable to light. Backside metallization and/or epoxy coating, along with frontside shading by the printed circuit board, reduce this sensitivity. However, the package has exposed die edges. In particular, DSBGA devices are sensitive to light, in the red and infrared range, shining on the package's exposed die edges.

## BOARD LAYOUT CONSIDERATIONS

PC board layout is an important part of DC-DC converter design. Poor board layout can disrupt the performance of a DC-DC converter and surrounding circuitry by contributing to EMI, ground bounce, and resistive voltage loss in the traces. These can send erroneous signals to the DC-DC converter IC, resulting in poor regulation or instability. Good layout for the LM3687 can be implemented by following a few simple design rules below. Refer to [Figure 28](#) for top layer board layout.

1. Place the LM3687, inductor and filter capacitor close together and make the traces short. The traces between these components carry relatively high switching currents and act as antennas. Following this rule reduces radiated noise. Special care must be given to place the input filter capacitor very close to the  $V_{BATT}$  and PGND pin. Place the output capacitor of the linear regulator close to the output pin.
2. Arrange the components so that the switching current loops curl in the same direction. During the first half of each cycle, current flows from the input filter capacitor through the LM3687 and inductor to the output filter capacitor and back through ground, forming a current loop. In the second half of each cycle, current is pulled up from ground through the LM3687 by the inductor to the output filter capacitor and then back through ground forming a second current loop. Routing these loops so the current curls in the same direction prevents magnetic field reversal between the two half-cycles and reduces radiated noise.
3. Connect the ground pins of the LM3687 and filter capacitors together using generous component-side copper fill as a pseudo-ground plane. Then, connect this to the ground-plane (if one is used) with several vias. This reduces ground-plane noise by preventing the switching currents from circulating through the ground plane. It also reduces ground bounce at the LM3687 by giving it a low impedance ground connection. Route SGND to the ground-plane by a separate trace.
4. Use wide traces between the power components and for power connections to the DC-DC converter circuit. This reduces voltage errors caused by resistive losses across the traces.
5. Route noise sensitive traces, such as the voltage feedback path (FB\_DCDC), away from noisy traces between the power components. The voltage feedback trace must remain close to the LM3687 circuit and should be direct but should be routed opposite to noisy components. This reduces EMI radiated onto the DC-DC converter's own voltage feedback trace. A good approach is to route the feedback trace on another layer and to have a ground plane between the top layer and layer on which the feedback trace is routed.
6. Place noise sensitive circuitry, such as radio IF blocks, away from the DC-DC converter, CMOS digital blocks and other noisy circuitry. Interference with noise sensitive circuitry in the system can be reduced through distance.

In mobile phones, for example, a common practice is to place the DC-DC converter on one corner of the board, arrange the CMOS digital circuitry around it (since this also generates noise), and then place sensitive preamplifiers and IF stages on the diagonally opposing corner. Often, the sensitive circuitry is shielded with a metal pan and power to it is postregulated to reduce conducted noise, a good field of application for the on-chip low-dropout linear regulator.

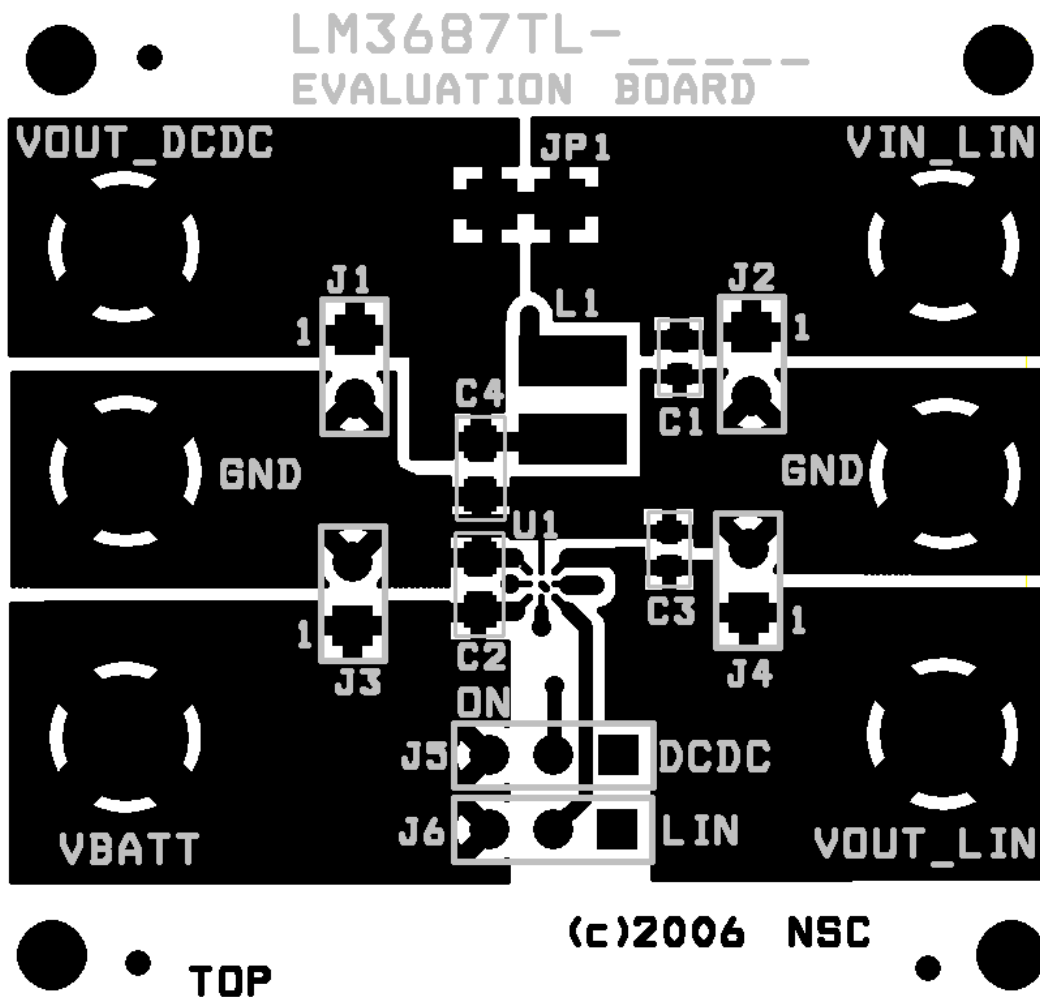



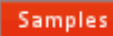


Figure 28. Top Layer Board Layout

**PACKAGING INFORMATION**

Orderable Device	Status (1)	Package Type	Package Drawing	Pins	Package Qty	Eco Plan (2)	Lead/Ball Finish	MSL Peak Temp (3)	Op Temp (°C)	Top-Side Markings (4)	Samples
LM3687TL-1812/NOPB	ACTIVE	DSBGA	YZR	9	250	Green (RoHS & no Sb/Br)	SNAGCU	Level-1-260C-UNLIM		SB	
LM3687TL-1815/NOPB	ACTIVE	DSBGA	YZR	9	250	Green (RoHS & no Sb/Br)	SNAGCU	Level-1-260C-UNLIM	-30 to 125	S9	
LM3687TLX-1812/NOPB	ACTIVE	DSBGA	YZR	9	3000	Green (RoHS & no Sb/Br)	SNAGCU	Level-1-260C-UNLIM		SB	
LM3687TLX-1815/NOPB	ACTIVE	DSBGA	YZR	9	3000	Green (RoHS & no Sb/Br)	SNAGCU	Level-1-260C-UNLIM	-30 to 125	S9	

(1) The marketing status values are defined as follows:

**ACTIVE:** Product device recommended for new designs.

**LIFEBUY:** TI has announced that the device will be discontinued, and a lifetime-buy period is in effect.

**NRND:** Not recommended for new designs. Device is in production to support existing customers, but TI does not recommend using this part in a new design.

**PREVIEW:** Device has been announced but is not in production. Samples may or may not be available.

**OBSOLETE:** TI has discontinued the production of the device.

(2) Eco Plan - The planned eco-friendly classification: Pb-Free (RoHS), Pb-Free (RoHS Exempt), or Green (RoHS & no Sb/Br) - please check <http://www.ti.com/productcontent> for the latest availability information and additional product content details.

**TBD:** The Pb-Free/Green conversion plan has not been defined.

**Pb-Free (RoHS):** TI's terms "Lead-Free" or "Pb-Free" mean semiconductor products that are compatible with the current RoHS requirements for all 6 substances, including the requirement that lead not exceed 0.1% by weight in homogeneous materials. Where designed to be soldered at high temperatures, TI Pb-Free products are suitable for use in specified lead-free processes.

**Pb-Free (RoHS Exempt):** This component has a RoHS exemption for either 1) lead-based flip-chip solder bumps used between the die and package, or 2) lead-based die adhesive used between the die and leadframe. The component is otherwise considered Pb-Free (RoHS compatible) as defined above.

**Green (RoHS & no Sb/Br):** TI defines "Green" to mean Pb-Free (RoHS compatible), and free of Bromine (Br) and Antimony (Sb) based flame retardants (Br or Sb do not exceed 0.1% by weight in homogeneous material)

(3) MSL, Peak Temp. -- The Moisture Sensitivity Level rating according to the JEDEC industry standard classifications, and peak solder temperature.

(4) Only one of markings shown within the brackets will appear on the physical device.

**Important Information and Disclaimer:** The information provided on this page represents TI's knowledge and belief as of the date that it is provided. TI bases its knowledge and belief on information provided by third parties, and makes no representation or warranty as to the accuracy of such information. Efforts are underway to better integrate information from third parties. TI has taken and continues to take reasonable steps to provide representative and accurate information but may not have conducted destructive testing or chemical analysis on incoming materials and chemicals. TI and TI suppliers consider certain information to be proprietary, and thus CAS numbers and other limited information may not be available for release.

In no event shall TI's liability arising out of such information exceed the total purchase price of the TI part(s) at issue in this document sold by TI to Customer on an annual basis.



**TAPE AND REEL INFORMATION**

**QUADRANT ASSIGNMENTS FOR PIN 1 ORIENTATION IN TAPE**


\*All dimensions are nominal

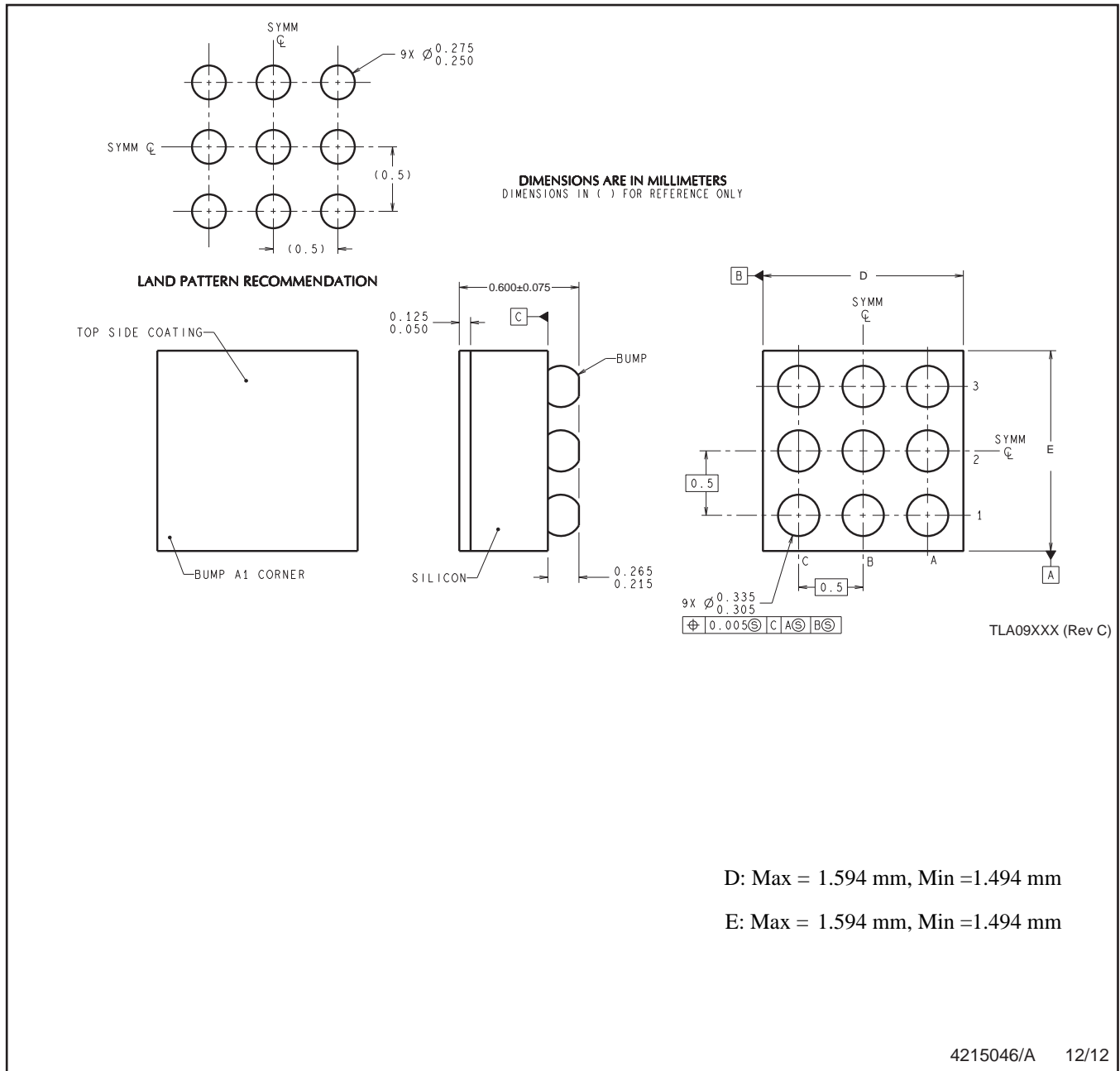
Device	Package Type	Package Drawing	Pins	SPQ	Reel Diameter (mm)	Reel Width W1 (mm)	A0 (mm)	B0 (mm)	K0 (mm)	P1 (mm)	W (mm)	Pin1 Quadrant
LM3687TL-1812/NOPB	DSBGA	YZR	9	250	178.0	8.4	1.7	1.7	0.76	4.0	8.0	Q1
LM3687TL-1815/NOPB	DSBGA	YZR	9	250	178.0	8.4	1.7	1.7	0.76	4.0	8.0	Q1
LM3687TLX-1812/NOPB	DSBGA	YZR	9	3000	178.0	8.4	1.7	1.7	0.76	4.0	8.0	Q1
LM3687TLX-1815/NOPB	DSBGA	YZR	9	3000	178.0	8.4	1.7	1.7	0.76	4.0	8.0	Q1

**TAPE AND REEL BOX DIMENSIONS**


\*All dimensions are nominal

Device	Package Type	Package Drawing	Pins	SPQ	Length (mm)	Width (mm)	Height (mm)
LM3687TL-1812/NOPB	DSBGA	YZR	9	250	203.0	190.0	41.0
LM3687TL-1815/NOPB	DSBGA	YZR	9	250	203.0	190.0	41.0
LM3687TLX-1812/NOPB	DSBGA	YZR	9	3000	206.0	191.0	90.0
LM3687TLX-1815/NOPB	DSBGA	YZR	9	3000	206.0	191.0	90.0

YZR0009



D: Max = 1.594 mm, Min =1.494 mm

E: Max = 1.594 mm, Min =1.494 mm

NOTES: A. All linear dimensions are in millimeters. Dimensioning and tolerancing per ASME Y14.5M-1994.  
B. This drawing is subject to change without notice.

## IMPORTANT NOTICE

Texas Instruments Incorporated and its subsidiaries (TI) reserve the right to make corrections, enhancements, improvements and other changes to its semiconductor products and services per JESD46, latest issue, and to discontinue any product or service per JESD48, latest issue. Buyers should obtain the latest relevant information before placing orders and should verify that such information is current and complete. All semiconductor products (also referred to herein as "components") are sold subject to TI's terms and conditions of sale supplied at the time of order acknowledgment.

TI warrants performance of its components to the specifications applicable at the time of sale, in accordance with the warranty in TI's terms and conditions of sale of semiconductor products. Testing and other quality control techniques are used to the extent TI deems necessary to support this warranty. Except where mandated by applicable law, testing of all parameters of each component is not necessarily performed.

TI assumes no liability for applications assistance or the design of Buyers' products. Buyers are responsible for their products and applications using TI components. To minimize the risks associated with Buyers' products and applications, Buyers should provide adequate design and operating safeguards.

TI does not warrant or represent that any license, either express or implied, is granted under any patent right, copyright, mask work right, or other intellectual property right relating to any combination, machine, or process in which TI components or services are used. Information published by TI regarding third-party products or services does not constitute a license to use such products or services or a warranty or endorsement thereof. Use of such information may require a license from a third party under the patents or other intellectual property of the third party, or a license from TI under the patents or other intellectual property of TI.

Reproduction of significant portions of TI information in TI data books or data sheets is permissible only if reproduction is without alteration and is accompanied by all associated warranties, conditions, limitations, and notices. TI is not responsible or liable for such altered documentation. Information of third parties may be subject to additional restrictions.

Resale of TI components or services with statements different from or beyond the parameters stated by TI for that component or service voids all express and any implied warranties for the associated TI component or service and is an unfair and deceptive business practice. TI is not responsible or liable for any such statements.

Buyer acknowledges and agrees that it is solely responsible for compliance with all legal, regulatory and safety-related requirements concerning its products, and any use of TI components in its applications, notwithstanding any applications-related information or support that may be provided by TI. Buyer represents and agrees that it has all the necessary expertise to create and implement safeguards which anticipate dangerous consequences of failures, monitor failures and their consequences, lessen the likelihood of failures that might cause harm and take appropriate remedial actions. Buyer will fully indemnify TI and its representatives against any damages arising out of the use of any TI components in safety-critical applications.

In some cases, TI components may be promoted specifically to facilitate safety-related applications. With such components, TI's goal is to help enable customers to design and create their own end-product solutions that meet applicable functional safety standards and requirements. Nonetheless, such components are subject to these terms.

No TI components are authorized for use in FDA Class III (or similar life-critical medical equipment) unless authorized officers of the parties have executed a special agreement specifically governing such use.

Only those TI components which TI has specifically designated as military grade or "enhanced plastic" are designed and intended for use in military/aerospace applications or environments. Buyer acknowledges and agrees that any military or aerospace use of TI components which have **not** been so designated is solely at the Buyer's risk, and that Buyer is solely responsible for compliance with all legal and regulatory requirements in connection with such use.

TI has specifically designated certain components as meeting ISO/TS16949 requirements, mainly for automotive use. In any case of use of non-designated products, TI will not be responsible for any failure to meet ISO/TS16949.

### Products

Audio	<a href="http://www.ti.com/audio">www.ti.com/audio</a>
Amplifiers	<a href="http://amplifier.ti.com">amplifier.ti.com</a>
Data Converters	<a href="http://dataconverter.ti.com">dataconverter.ti.com</a>
DLP® Products	<a href="http://www.dlp.com">www.dlp.com</a>
DSP	<a href="http://dsp.ti.com">dsp.ti.com</a>
Clocks and Timers	<a href="http://www.ti.com/clocks">www.ti.com/clocks</a>
Interface	<a href="http://interface.ti.com">interface.ti.com</a>
Logic	<a href="http://logic.ti.com">logic.ti.com</a>
Power Mgmt	<a href="http://power.ti.com">power.ti.com</a>
Microcontrollers	<a href="http://microcontroller.ti.com">microcontroller.ti.com</a>
RFID	<a href="http://www.ti-rfid.com">www.ti-rfid.com</a>
OMAP Applications Processors	<a href="http://www.ti.com/omap">www.ti.com/omap</a>
Wireless Connectivity	<a href="http://www.ti.com/wirelessconnectivity">www.ti.com/wirelessconnectivity</a>

### Applications

Automotive and Transportation	<a href="http://www.ti.com/automotive">www.ti.com/automotive</a>
Communications and Telecom	<a href="http://www.ti.com/communications">www.ti.com/communications</a>
Computers and Peripherals	<a href="http://www.ti.com/computers">www.ti.com/computers</a>
Consumer Electronics	<a href="http://www.ti.com/consumer-apps">www.ti.com/consumer-apps</a>
Energy and Lighting	<a href="http://www.ti.com/energy">www.ti.com/energy</a>
Industrial	<a href="http://www.ti.com/industrial">www.ti.com/industrial</a>
Medical	<a href="http://www.ti.com/medical">www.ti.com/medical</a>
Security	<a href="http://www.ti.com/security">www.ti.com/security</a>
Space, Avionics and Defense	<a href="http://www.ti.com/space-avionics-defense">www.ti.com/space-avionics-defense</a>
Video and Imaging	<a href="http://www.ti.com/video">www.ti.com/video</a>

### TI E2E Community

[e2e.ti.com](http://e2e.ti.com)