

HIGH SPEED DUAL COMPARATORS

- TWO INDEPENDENT COMPARATORS
- OPERATES FROM A SINGLE +5V SUPPLY
- TYPICALLY 80ns RESPONSE TIME AT $\pm 15V$
- MINIMUM FAN-OUT OF 2 EACH SIDE
- MAXIMUM INPUT CURRENT OF $1\mu A$ OVER OPERATING TEMPERATURE RANGE
- INPUTS AND OUTPUTS CAN BE ISOLATED FROM SYSTEM GROUND
- HIGH COMMON-MODE SLEW RATE

DESCRIPTION

These products are precision high speed dual comparators designed to operate over a wide range of supply voltages down to a single 5V logic supply and ground and have low input currents and high gains.

The open collector of the output stage makes compatible with TTL as well as capable of driving lamps and relays at currents up to 25mA.

Although designed primarily for applications requiring operation from digital logic supplies, are fully specified for power supplies up to $\pm 15V$.

They feature faster response than the LM111 at the expense of higher power dissipation. However, the high speed, wide operating voltage range and low package count make the much more versatile.

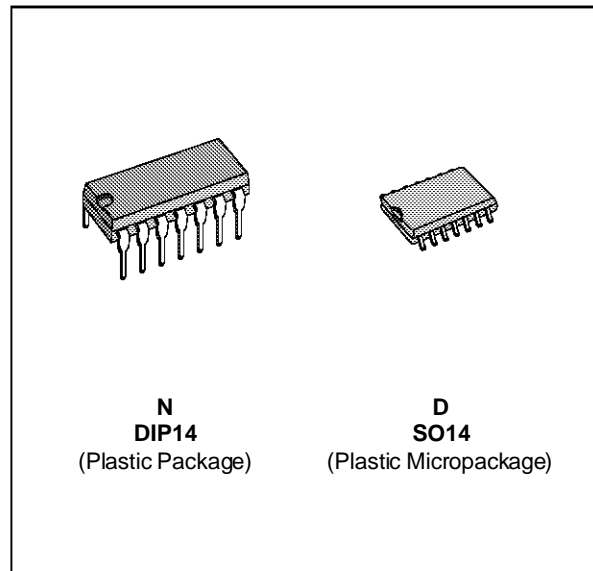

ORDER CODES

Part Number	Temperature Range	Package	
		N	D
LM119	-55, +125°C	•	•
LM219	-40, +105°C	•	•
LM319	0, +70°C	•	•

Example : LM219N

119-01.TBL

PIN CONNECTIONS (top view)

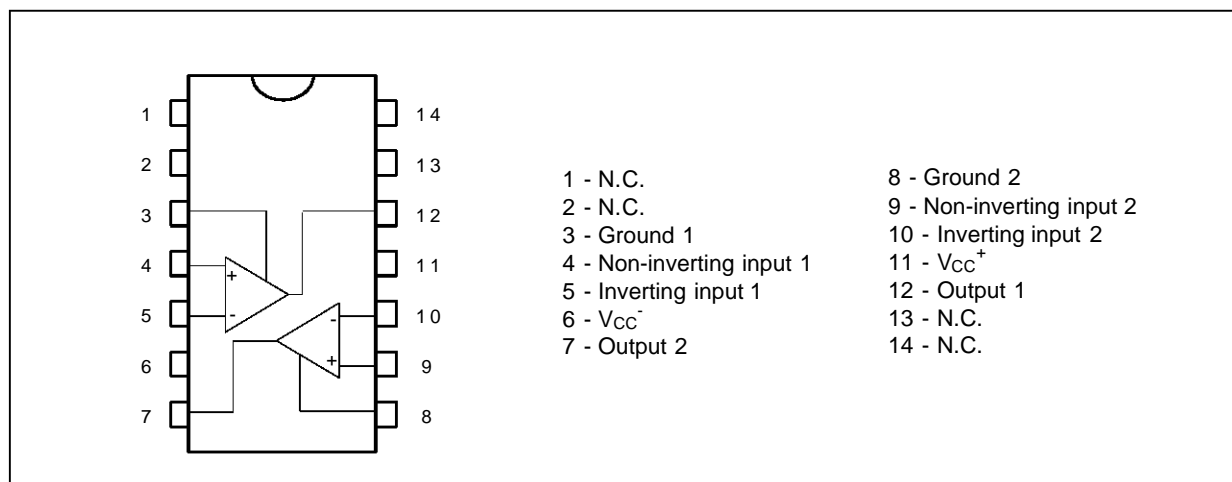

LM119 - LM219 - LM319

SCHEMATIC DIAGRAM

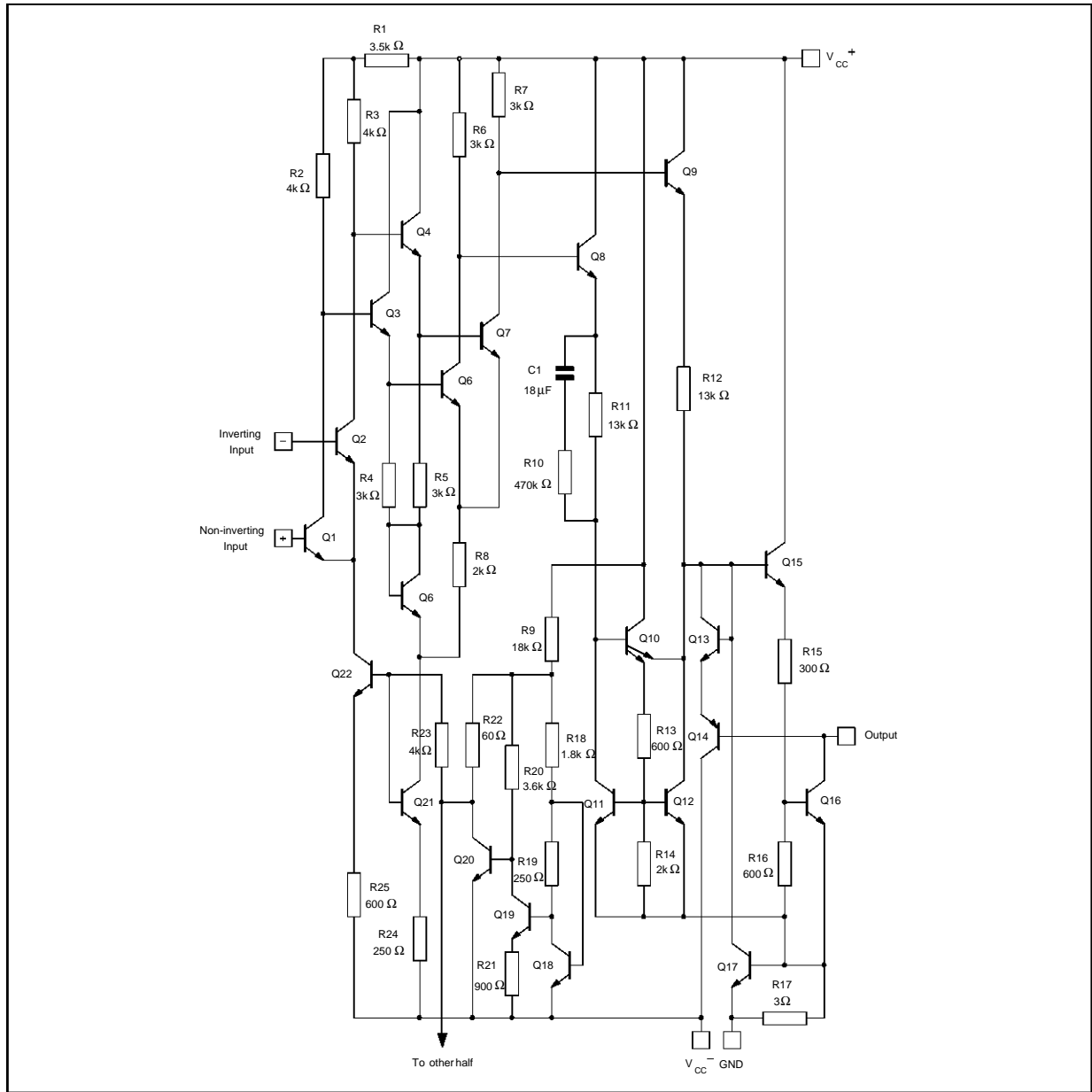

ABSOLUTE MAXIMUM RATINGS

Symbol	Parameter	LM119	LM219	LM319	Unit
$V_O - V_{CC}^-$	Output to Negative Supply Voltage	36	36	36	V
V_{CC}^-	Negative Supply Voltage	25	25	25	V
V_{CC}^+	Positive Supply Voltage	18	18	18	V
V_{id}	Differential Input Voltage	± 5	± 5	± 5	V
V_i	Input Voltage – (note 1)	± 15	± 15	± 15	V
P_{tot}	Power Dissipation	500	500	500	mW
T_{oper}	Operating Free-air Temperature Range	-55 to +125	-40 to +105	0 to +70	°C
T_{stg}	Storage Temperature Range	-65 to +150	-65 to +150	-65 to +150	°C

ELECTRICAL CHARACTERISTICS

$V_{CC} = \pm 15V$, $T_{amb} = 25^{\circ}C$ (unless otherwise specified)

Symbol	Parameter	LM119 - LM219			LM319			Unit
		Min.	Typ.	Max.	Min.	Typ.	Max.	
V_{io}	Input Offset Voltage ($R_s \leq 5k\Omega$) – (note 2) $T_{amb} = +25^{\circ}C$ $T_{min.} \leq T_{amb} \leq T_{max.}$		0.7	4 7		2	8 10	mV
I_{io}	Input Offset Current – (note 2) $T_{amb} = +25^{\circ}C$ $T_{min.} \leq T_{amb} \leq T_{max.}$		30	75 100		80	200 300	nA
I_{ib}	Input Bias Current – (note 2) $T_{amb} = +25^{\circ}C$ $T_{min.} \leq T_{amb} \leq T_{max.}$		150	500 1000		250	1000 1200	nA
A_{vd}	Large Signal Voltage Gain	10	40		8	40		V/mV
I_{CC}^{+}	Positive Supply Current $V_{CC} = \pm 15V$ $V_{CC}^{+} = +5V, V_{CC}^{-} = 0V$		8 4.3	11.5		8 4.3	12.5	mA
I_{CC}^{-}	Negative Supply Current		3	4.5		3	5	mA
V_{icm}	Input Common Mode Voltage Range $V_{CC} = \pm 15V$ $V_{CC}^{+} = +5V, V_{CC}^{-} = 0V$	± 12 1	± 13	3	± 12 1	± 13	3	V
V_{id}	Differential Input Voltage			± 5			± 5	V
V_{OL}	Low Level Output Voltage $T_{amb} = +25^{\circ}C, I_O = 25mA$ $V_i \leq -5mV$ $V_i \leq -10mV$ $T_{min.} \leq T_{amb} \leq T_{max.}$ $V_{CC}^{+} \geq +4.5V, V_{CC}^{-} = 0V, I_{O(sink)} < 3.2mA$ $V_i \leq -6mV$ $V_i \leq -10mV$		0.75 0.23	1.5 0.4		0.75 0.3	1.5 0.4	V
I_{OH}	High Level Output Current ($V_O = +35V$) $T_{amb} = +25^{\circ}C$ $V_i \geq 5mV$ $V_i \geq 10mV$ $T_{min.} \leq T_{amb} \leq T_{max.}$ $V_i \geq 5mV$		0.2 1	2 10		0.2	10	μA
t_{re}	Response Time – (note 3)		80			80		ns

119-03.TBL

- Notes :**
- For supply voltages less than $\pm 15V$ the absolute maximum input voltage is equal to the supply voltage.
 - These specifications apply for $V_{CC} = \pm 15V$, unless otherwise stated. The offset voltage, offset current and bias current specifications apply for any supply voltage from a single +5V supply up to $\pm 15V$ supplies. The offset voltages and offset current given are the maximum values required to drive the output down to 1V or up to +14V with a 1mA load current. Thus, these parameters define an error band and take into account the worst case effects of voltage gain and input impedance.
 - The response time specified is for a 100mV input step with 5mV overdrive.

LM119-LM219

INPUT BIAS CURRENTS

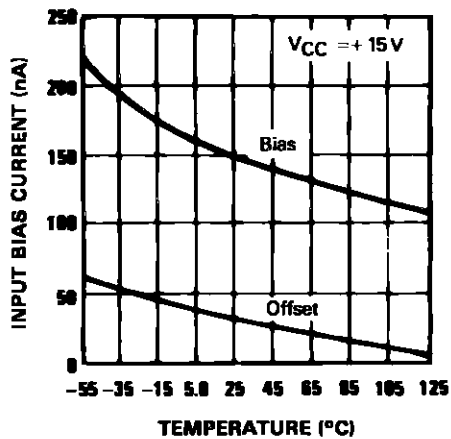

COMMON MODE LIMITS

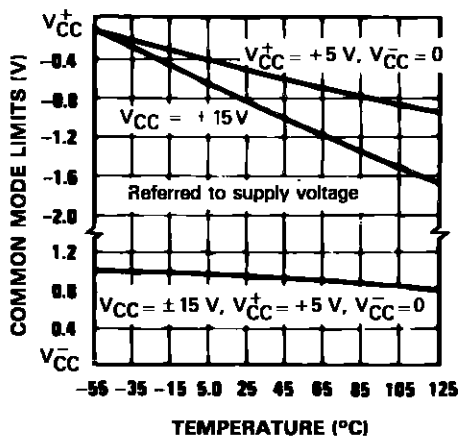

OUTPUT SATURATION VOLTAGE

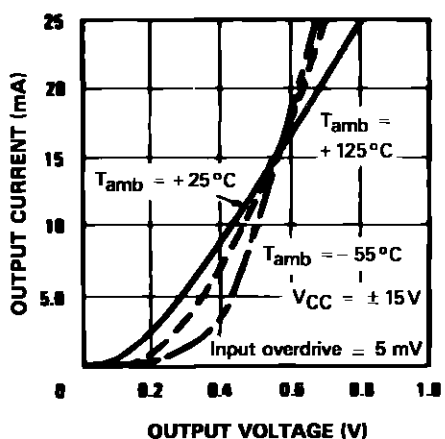

SUPPLY CURRENT

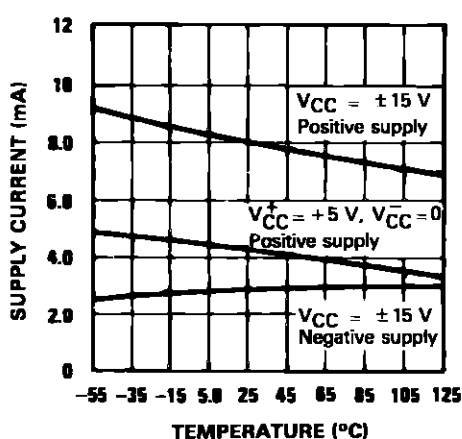

SUPPLY CURRENT

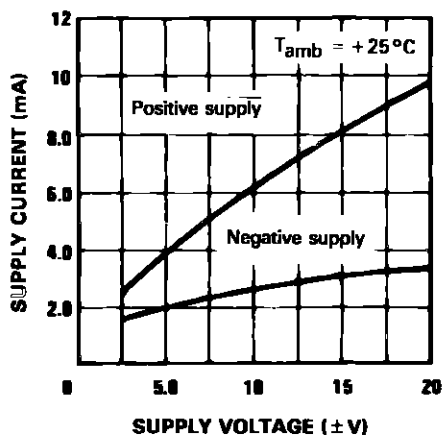

OUTPUT LIMITING CHARACTERISTICS

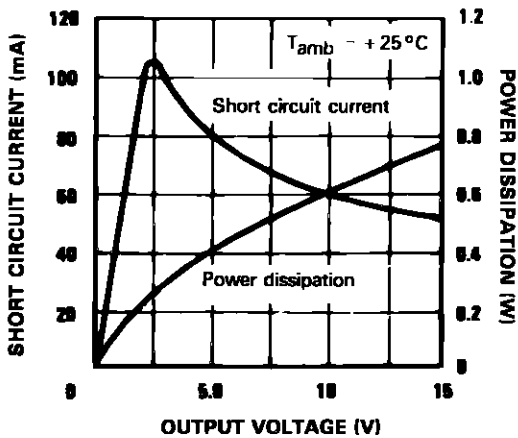

LM319

INPUT BIAS CURRENTS

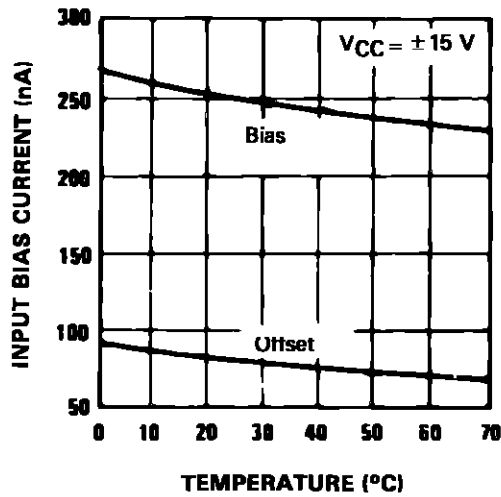

COMMON MODE LIMITS

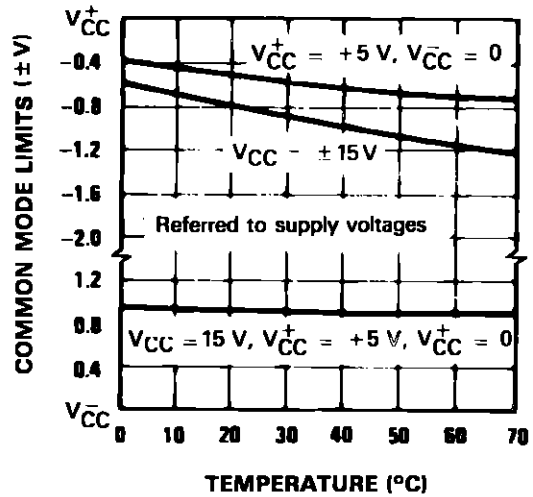

OUTPUT SATURATION VOLTAGE

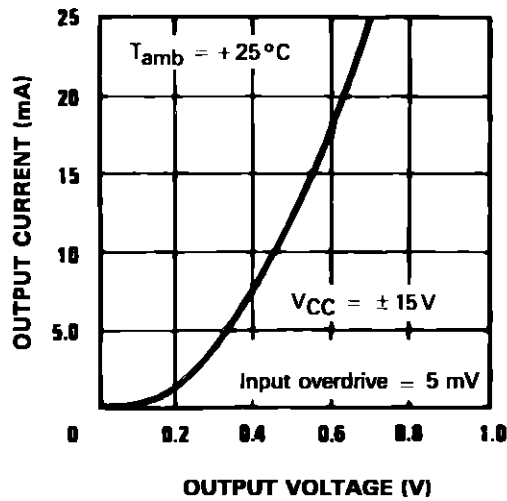

SUPPLY CURRENT

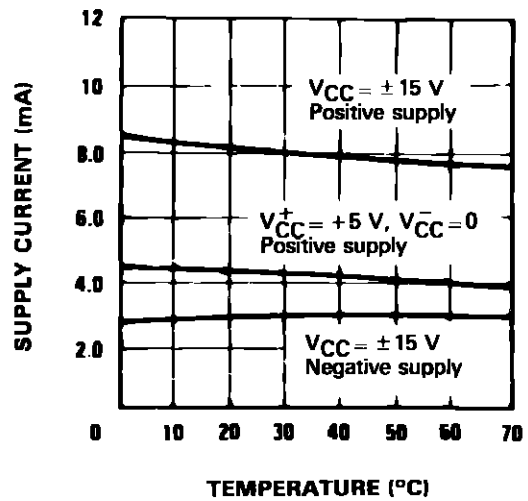

119-05.EPS

TRANSFER FUNCTION

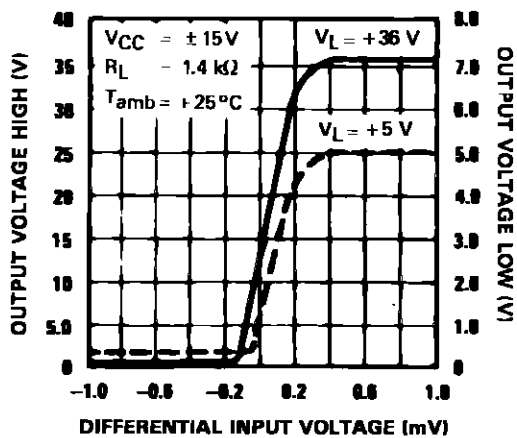

INPUT CHARACTERISTICS

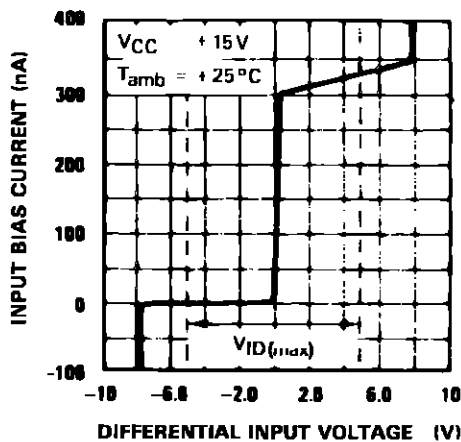

RESPONSE TIME FOR VARIOUS INPUT OVERDRIVES

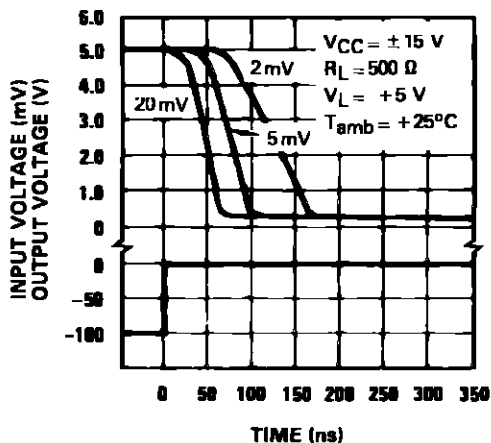

RESPONSE TIME FOR VARIOUS INPUT OVERDRIVES

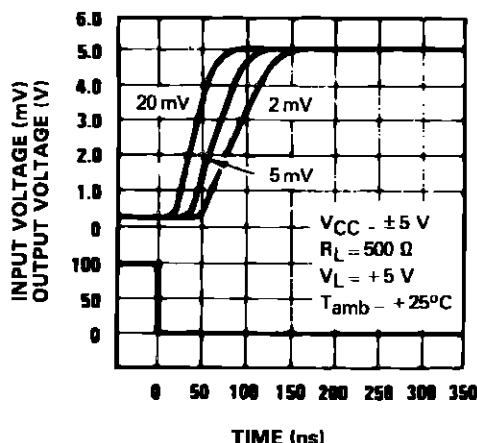

RESPONSE TIME FOR VARIOUS INPUT OVERDRIVES

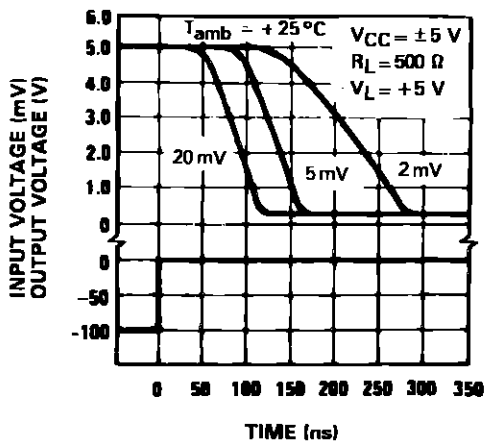

RESPONSE TIME FOR VARIOUS INPUT OVERDRIVES

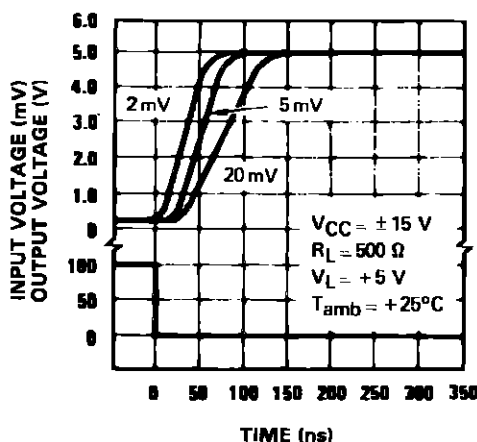

TYPICAL APPLICATION DIAGRAMS

RELAY DRIVER

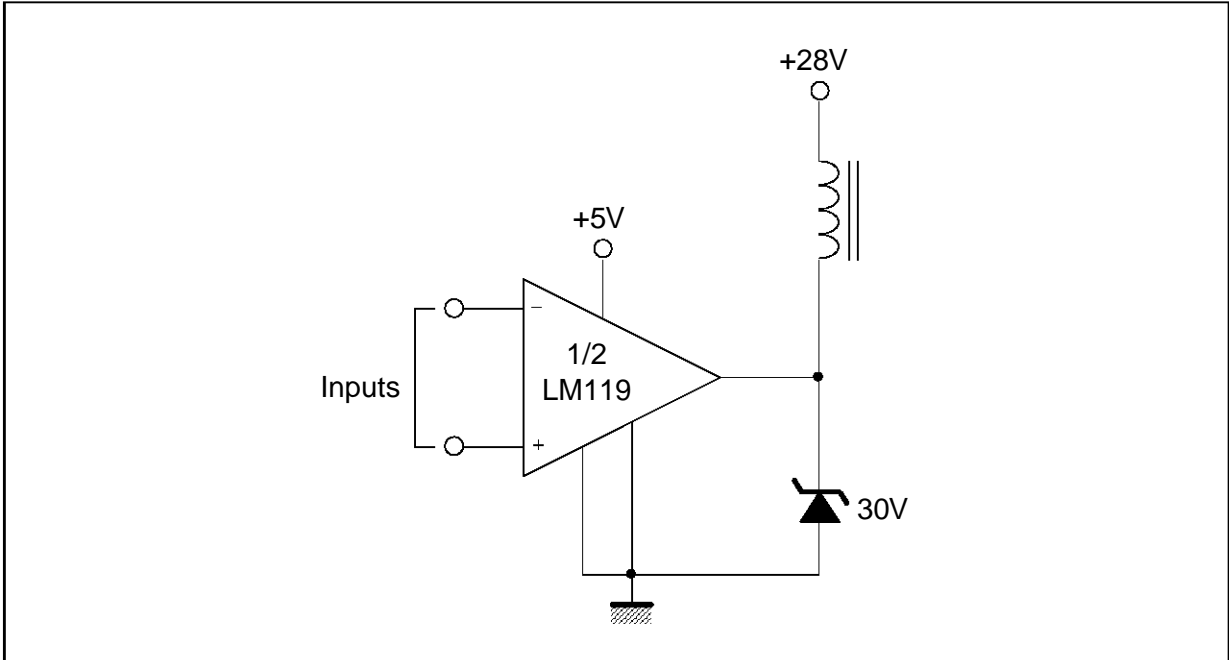

119-07.EPS

WINDOW DETECTOR

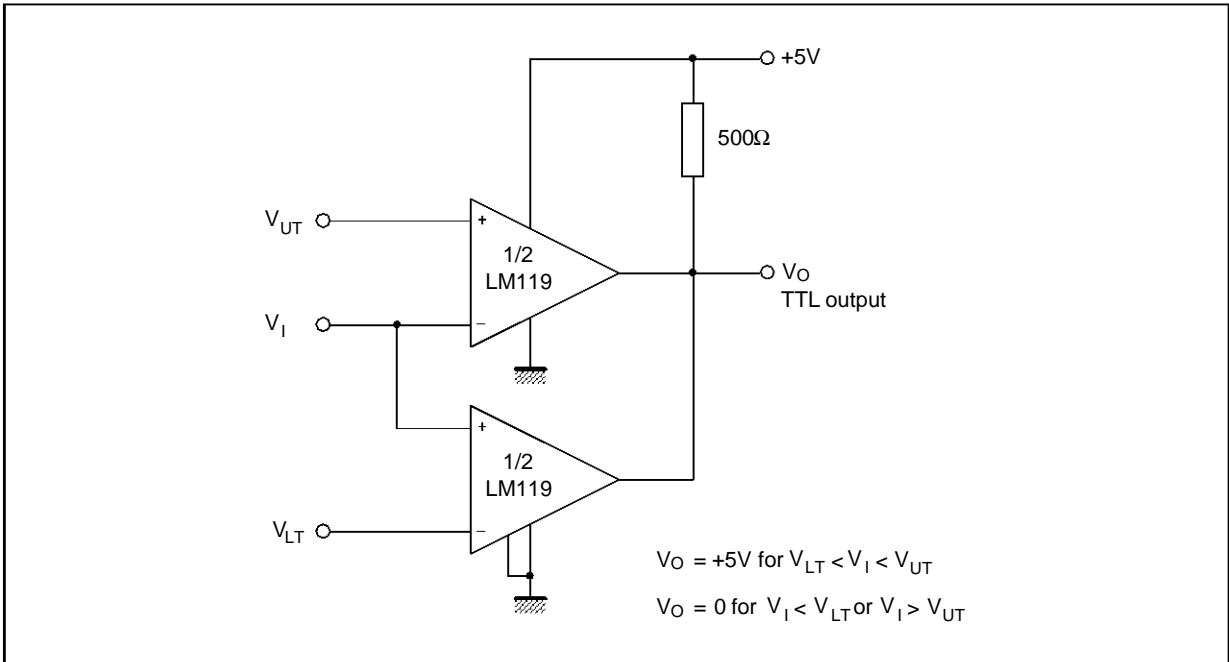

119-08.EPS

LM119 - LM219 - LM319

PACKAGE MECHANICAL DATA
14 PINS – PLASTIC DIP OR CERDIP

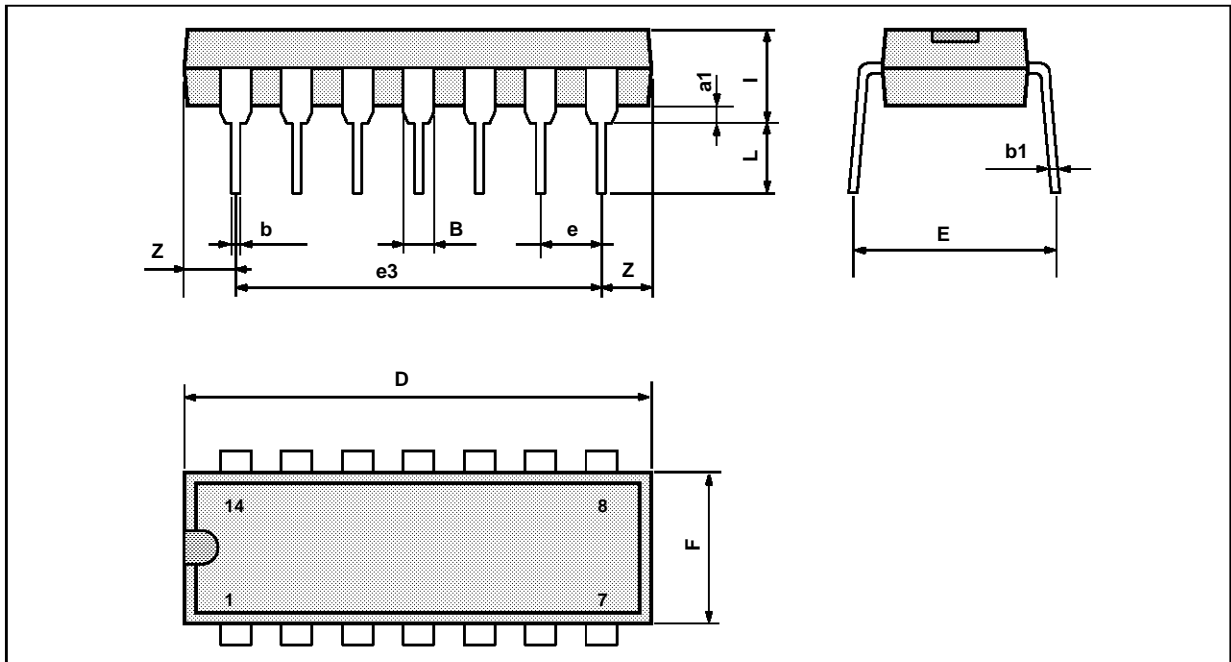

PM-DIP14.EPS

Dimensions	Millimeters			Inches		
	Min.	Typ.	Max.	Min.	Typ.	Max.
a1	0.51			0.020		
B	1.39		1.65	0.055		0.065
b		0.5			0.020	
b1		0.25			0.010	
D			20			0.787
E		8.5			0.335	
e		2.54			0.100	
e3		15.24			0.600	
F			7.1			0.280
i			5.1			0.201
L		3.3			0.130	
Z	1.27		2.54	0.050		0.100

DIP14.TBL

PACKAGE MECHANICAL DATA
14 PINS – PLASTIC MICROPACKAGE (SO)

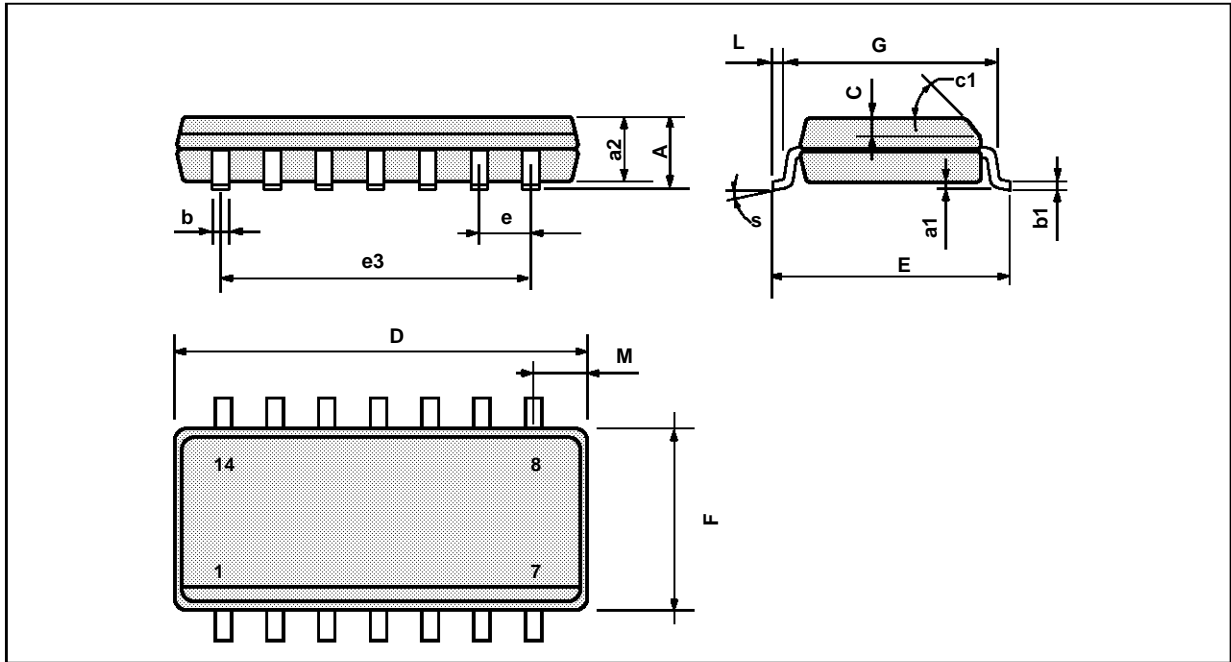

PM-SO14.EPS

Dimensions	Millimeters			Inches		
	Min.	Typ.	Max.	Min.	Typ.	Max.
A			1.75			0.069
a1	0.1		0.2	0.004		0.008
a2			1.6			0.063
b	0.35		0.46	0.014		0.018
b1	0.19		0.25	0.007		0.010
C		0.5			0.020	
c1	45° (typ.)					
D	8.55		8.75	0.336		0.334
E	5.8		6.2	0.228		0.244
e		1.27			0.050	
e3		7.62			0.300	
F	3.8		4.0	0.150		0.157
G	4.6		5.3	0.181		0.208
L	0.5		1.27	0.020		0.050
M			0.68			0.027
S	8° (max.)					

SO14.TBL

Information furnished is believed to be accurate and reliable. However, SGS-THOMSON Microelectronics assumes no responsibility for the consequences of use of such information nor for any infringement of patents or other rights of third parties which may result from its use. No licence is granted by implication or otherwise under any patent or patent rights of SGS-THOMSON Microelectronics. Specifications mentioned in this publication are subject to change without notice. This publication supersedes and replaces all information previously supplied. SGS-THOMSON Microelectronics products are not authorized for use as critical components in life support devices or systems without express written approval of SGS-THOMSON Microelectronics.

© 1994 SGS-THOMSON Microelectronics - All Rights Reserved

SGS-THOMSON Microelectronics GROUP OF COMPANIES

Australia - Brazil - France - Germany - Hong Kong - Italy - Japan - Korea - Malaysia - Malta - Morocco - The Netherlands
Singapore - Spain - Sweden - Switzerland - Taiwan - Thailand - United Kingdom - U.S.A.

ORDER CODE :