



LM2935 Low Dropout Dual Regulator

General Description

The LM2935 dual 5V regulator provides a 750 mA output as well as a 10 mA standby output. It features a low quiescent current of 3 mA or less when supplying 10 mA loads from the 5V standby regulator output. This unique characteristic and the extremely low input-output differential required for proper regulation (0.55V for output currents of 10 mA) make the LM2935 the ideal regulator for power systems that include standby memory. Applications include microprocessor power supplies demanding as much as 750 mA of output current.

Designed for automotive applications, the LM2935 and all regulated circuitry are protected from reverse battery installations or 2 battery jumps. During line transients, such as a load dump (60V) when the input voltage to the regulator can momentarily exceed the specified maximum operating voltage, the 0.75A regulator will automatically shut down to protect both internal circuits and the load while the standby regulator will continue to power any standby load. The LM2935 cannot be harmed by temporary mirror-image insertion. Familiar regulator features such as short circuit and thermal overload protection are also provided.

Features

- Two 5V regulated outputs
- Output current in excess of 750 mA
- Low quiescent current standby regulator
- Input-output differential less than 0.6V at 0.5A
- Reverse battery protection
- 60V load dump protection
- -50V reverse transient protection
- Short circuit protection
- Internal thermal overload protection
- Available in 5-lead TO-220
- ON/OFF switch controls high current output
- Reset error flag
- P+ Product Enhancement tested

Typical Application Circuit

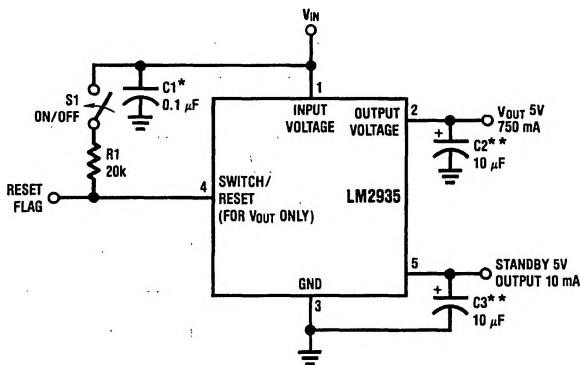

*Required if regulator is located far from power supply filter.

**C_{OUT} must be at least 10 μF to maintain stability. May be increased without bound to maintain regulation during transients. Locate as close as possible to the regulator. This capacitor must be rated over the same operating temperature range as the regulator. The equivalent series resistance (ESR) of this capacitor is critical; see curve.

TL/H/5232-1

FIGURE 1. Test and Application Circuit

Connection Diagram

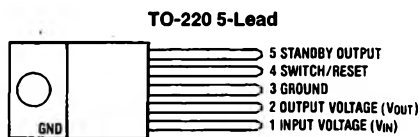

Front View

TL/H/5232-8

Order Number LM2935T
See NS Package Number T05A

Absolute Maximum Ratings

If Military/Aerospace specified devices are required, please contact the National Semiconductor Sales Office/Distributors for availability and specifications.

Input Voltage

Operating Range	26V
Overvoltage Protection	60V

Internal Power Dissipation (Note 1)

Operating Temperature Range

Maximum Junction Temperature

Storage Temperature Range

Lead Temp. (Soldering, 10 seconds)

Internally Limited

-40°C to +125°C

150°C

-65°C to +150°C

230°C

Electrical Characteristics for V_{OUT}

V_{IN} = 14V, I_O = 500 mA, T_J = 25°C (Note 4), C₂ = 10 μF (unless otherwise specified)

Parameter	Conditions	Typ	Tested Limit (Note 3)	Units Limit
Output Voltage	6V ≤ V _{IN} ≤ 26V, 5 mA ≤ I _O ≤ 500 mA, -40°C ≤ T _J ≤ 125°C (Note 2)	5.00	5.25 4.75	V _{MAX} V _{MIN}
Line Regulation	9V ≤ V _{IN} ≤ 16V, I _O = 5 mA 6V ≤ V _{IN} ≤ 26V, I _O = 5 mA	4 10	25 50	mV _{MAX} mV _{MAX}
Load Regulation	5 mA ≤ I _O ≤ 500 mA	10	50	mV _{MAX}
Output Impedance	500 mA _{DC} and 10 mA _{rms} , 100 Hz–10 kHz	200		mΩ
Quiescent Current	I _O ≤ 10 mA, No Load on Standby I _O = 500 mA, No Load on Standby I _O = 750 mA, No Load on Standby	3 40 90	100	mA mA _{MAX} mA
Output Noise Voltage	10 Hz–100 kHz	100		μV _{rms}
Long Term Stability		20		mV/1000 hr
Ripple Rejection	f _O = 120 Hz	66		dB
Dropout Voltage	I _O = 500 mA I _O = 750 mA	0.45 0.82	0.6	V _{MAX}
Current Limit		1.2	0.75	A _{MIN}
Maximum Operational Input Voltage		31	26	V _{MIN}
Maximum Line Transient	V _O ≤ 5.5V	70	60	V
Reverse Polarity Input Voltage, DC		-30	-15	V
Reverse Polarity Input Voltage, Transient	1% Duty Cycle, τ ≤ 100 ms, 10Ω Load	-80	-50	V
Reset Output Voltage				
Low	R1 = 20k, V _{IN} = 4.0V	0.9	1.2	V _{MAX}
High	R1 = 20k, V _{IN} = 14V	5.0	6.0 4.5	V _{MAX} V _{MIN}
Reset Output Current	Reset = 1.2V	5		mA
ON/OFF Resistor	R1 (± 10% Tolerance)		20	kΩ _{MAX}

Note 1: Thermal resistance without a heat sink for junction to case temperature is 3°C/W (TO-220). Thermal resistance for TO-220 case to ambient temperature is 50° C/W.

Note 2: The temperature extremes are guaranteed but not 100% production tested. This parameter is not used to calculate outgoing AQL.

Note 3: Tested Limits are guaranteed and 100% tested in production.

Note 4: To ensure constant junction temperature, low duty cycle pulse testing is used.

Electrical Characteristics for Standby Output

$I_O = 10 \text{ mA}$, $V_{IN} = 14 \text{ V}$, S1 open, $C_{OUT} = 10 \text{ } \mu\text{F}$, $T_J = 25^\circ\text{C}$ (Note 4), (unless otherwise specified)

Parameter	Standby Output Conditions	Typ	Tested Limit	Units Limit
Output Voltage	$I_O \leq 10 \text{ mA}$, $6 \text{ V} \leq V_{IN} \leq 26 \text{ V}$, $-40^\circ\text{C} \leq T_J \leq 125^\circ\text{C}$	5.00	5.25 4.75	V_{MAX} V_{MIN}
Tracking	V_{OUT} —Standby Output Voltage	50	200	mV_{MAX}
Line Regulation	$6 \text{ V} \leq V_{IN} \leq 26 \text{ V}$	4	50	mV_{MAX}
Load Regulation	$1 \text{ mA} \leq I_O \leq 10 \text{ mA}$	10	50	mV_{MAX}
Output Impedance	10 mA_{DC} and 1 mA_{RMS} , 100 Hz–10 kHz	1		Ω
Quiescent Current	$I_O \leq 10 \text{ mA}$, V_{OUT} OFF (Note 2)	2	3	mA_{MAX}
Output Noise Voltage	10 Hz–100 kHz	300		μV
Long Term Stability		20		$\text{mV}/1000 \text{ hr}$
Ripple Rejection	$f_O = 120 \text{ Hz}$	66		dB
Dropout Voltage	$I_O \leq 10 \text{ mA}$	0.55	0.7	V_{MAX}
Current Limit		70	25	mA_{MIN}
Maximum Operational Input Voltage	$V_O \leq 6 \text{ V}$	70	60	V_{MIN}
Reverse Polarity Input Voltage, DC	$V_O \geq -0.3 \text{ V}$, 510Ω Load	-30	-15	V_{MIN}
Reverse Polarity Input Voltage, Transient	1% Duty Cycle $T \leq 100 \text{ ms}$ 500Ω Load	-80	-50	V_{MIN}

Typical Circuit Waveforms

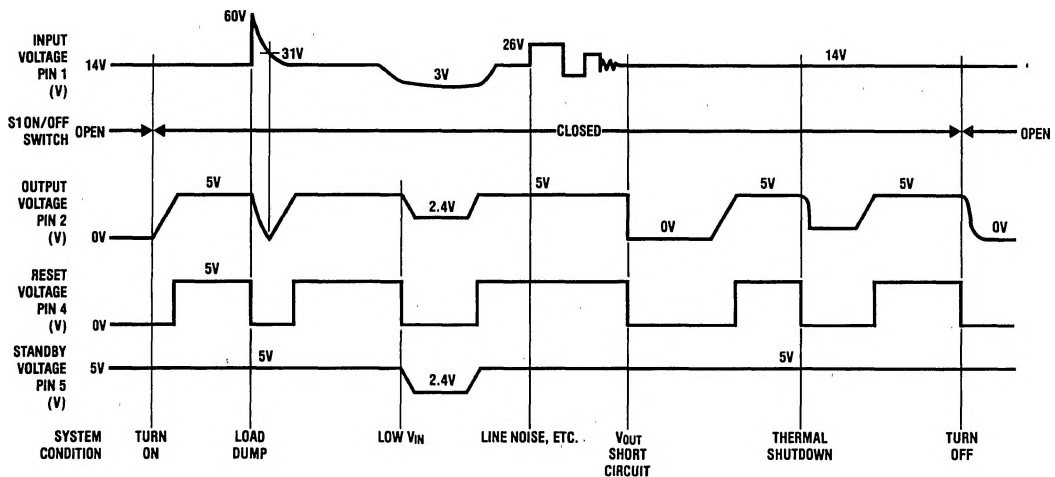
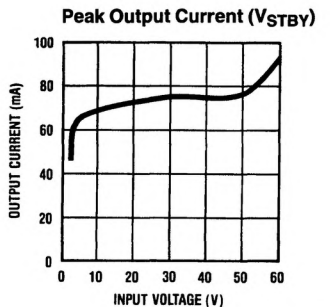
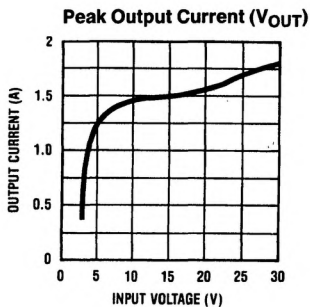
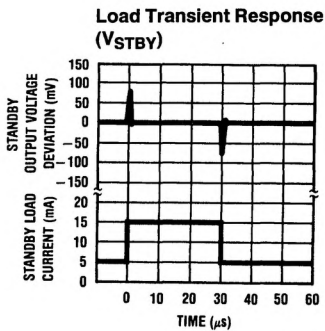
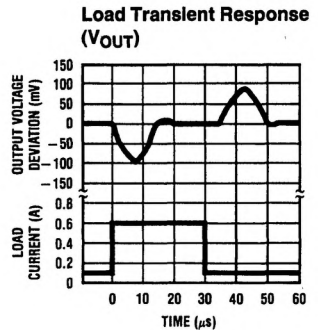
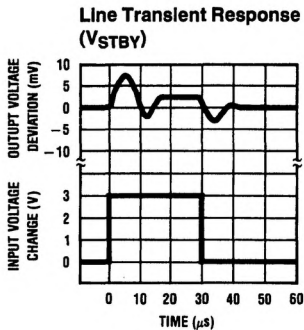
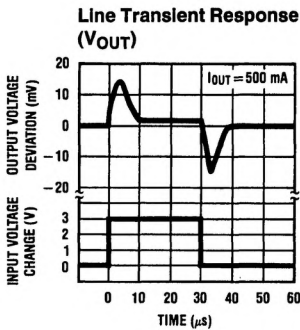
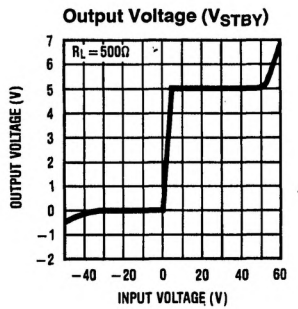
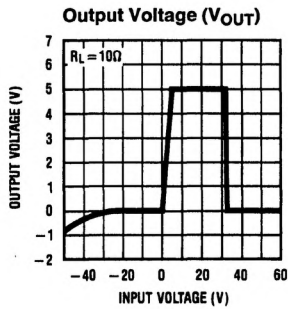
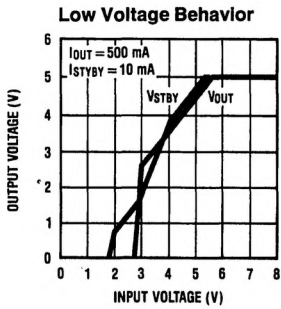
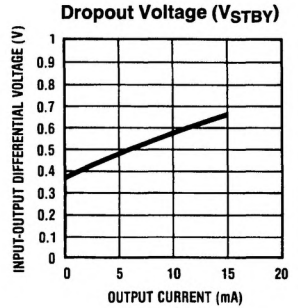
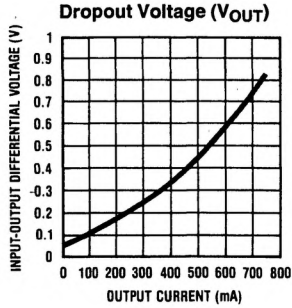
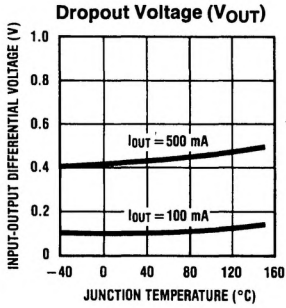

FIGURE 2

TL/H/5232-2

Typical Performance Characteristics



Typical Performance Characteristics (Continued)

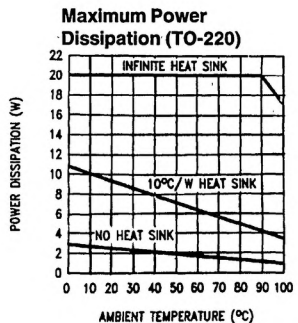
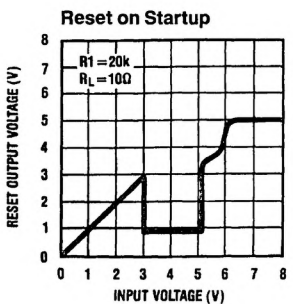
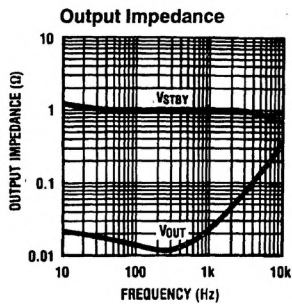
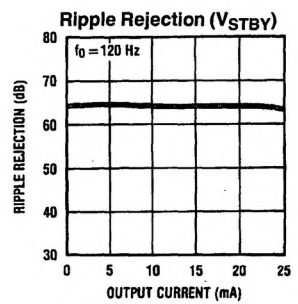
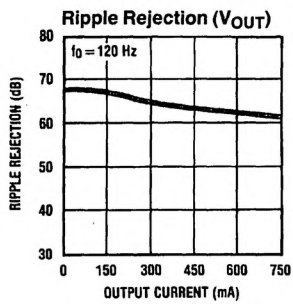
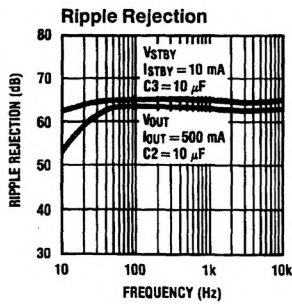
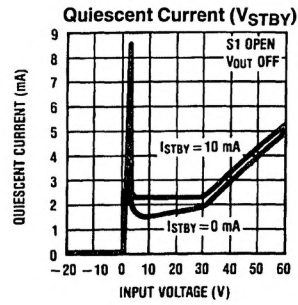
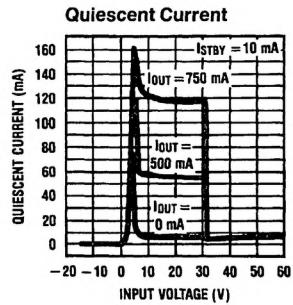
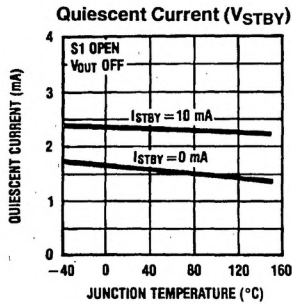
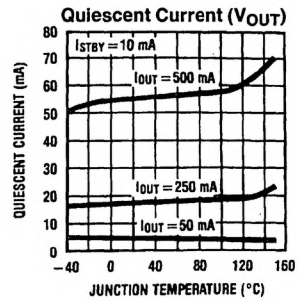
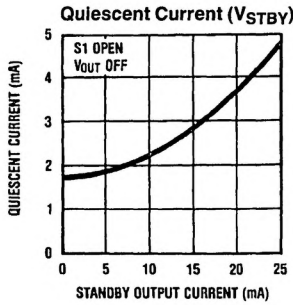
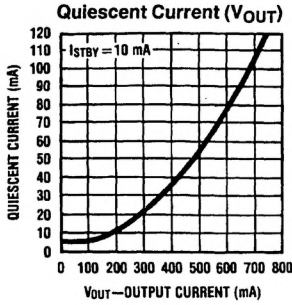

Typical Performance Characteristics (Continued)

Output Capacitor ESR (Standby Output, Pin 5)

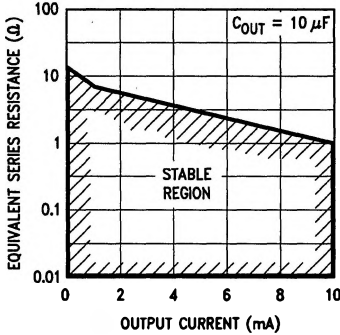

TL/H/5232-9

Output Capacitor ESR (Main Output, Pin 2)

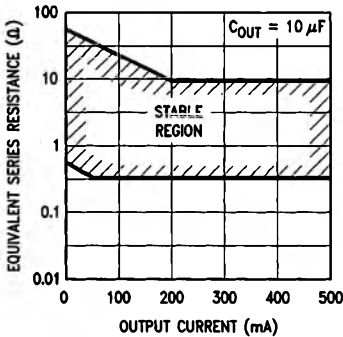

TL/H/5232-10

Definition of Terms

Dropout Voltage: The input-output voltage differential at which the circuit ceases to regulate against further reduction in input voltage. Measured when the output voltage has dropped 100 mV from the nominal value obtained at 14V input, dropout voltage is dependent upon load current and junction temperature.

Input Voltage: The DC voltage applied to the input terminals with respect to ground.

Input-Output Differential: The voltage difference between the unregulated input voltage and the regulated output voltage for which the regulator will operate.

Line Regulation: The change in output voltage for a change in the input voltage. The measurement is made under conditions of low dissipation or by using pulse techniques such that the average chip temperature is not significantly affected.

Load Regulation: The change in output voltage for a change in load current at constant chip temperature.

Long Term Stability: Output voltage stability under accelerated life-test conditions after 1000 hours with maximum rated voltage and junction temperature.

Output Noise Voltage: The rms AC voltage at the output, with constant load and no input ripple, measured over a specified frequency range.

Quiescent Current: The part of the positive input current that does not contribute to the positive load current. The regulator ground lead current.

Ripple Rejection: The ratio of the peak-to-peak input ripple voltage to the peak-to-peak output ripple voltage.

Temperature Stability of V_O : The percentage change in output voltage for a thermal variation from room temperature to either temperature extreme.

Application Hints

EXTERNAL CAPACITORS

The LM2935 output capacitors are required for stability. Without them, the regulator outputs will oscillate, sometimes by many volts. Though the $10\mu\text{F}$ shown are the minimum recommended values, actual size and type may vary depending upon the application load and temperature range. Capacitor effective series resistance (ESR) also factors in the IC stability. Since ESR varies from one brand to the next, some bench work may be required to determine the minimum capacitor value to use in production. Worst-case is usually determined at the minimum ambient temperature and maximum load expected.

Output capacitors can be increased in size to any desired value above the minimum. One possible purpose of this would be to maintain the output voltage during brief conditions of negative input transients that might be characteristic of a particular system.

Capacitors must also be rated at all ambient temperatures expected in the system. Many aluminum type electrolytics will freeze at temperatures less than -30°C , reducing their effective capacitance to zero. To maintain regulator stability down to -40°C , capacitors rated at that temperature (such as tantalums) must be used.

No capacitor must be attached to the ON/OFF and ERROR FLAG pin. Due to the internal circuits of the IC, oscillation on this pin could result.

STANDBY OUTPUT

The LM2935 differs from most fixed voltage regulators in that it is equipped with two regulator outputs instead of one. The additional output is intended for use in systems requiring standby memory circuits. While the high current regulator output can be controlled with the ON/OFF pin described below, the standby output remains on under all conditions as long as sufficient input voltage is applied to the IC. Thus, memory and other circuits powered by this output remain unaffected by positive line transients, thermal shutdown, etc.

The standby regulator circuit is designed so that the quiescent current to the IC is very low ($<3\text{ mA}$) when the other regulator output is off.

Application Hints (Continued)

In applications where the standby output is not needed, it may be disabled by connecting a resistor from the standby output to the supply voltage. This eliminates the need for a more expensive capacitor on the output to prevent unwanted oscillations. The value of the resistor depends upon the minimum input voltage expected for a given system. Since the standby output is shunted with an internal 5.7V zener (Figure 3), the current through the external resistor should be sufficient to bias R2 and R3 up to this point. Approximately 60 μA will suffice, resulting in a 10k external resistor for most applications (Figure 4).

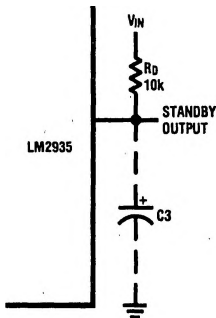

TL/H/5232-6

FIGURE 4. Disabling Standby Output to Eliminate C3

HIGH CURRENT OUTPUT

Unlike the standby regulated output, which must remain on whenever possible, the high current regulated output is fault protected against overvoltage and also incorporates thermal shutdown. If the input voltage rises above approximately 30V (e.g., load dump), this output will automatically shut-down. This protects the internal circuitry and enables the IC to survive higher voltage transients than would otherwise be expected. Thermal shutdown is effective against die overheating since the high current output is the dominant source of power dissipation in the IC.

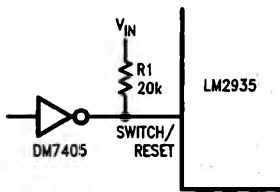

TL/H/5232-7

FIGURE 5. Controlling ON/OFF Terminal with a Typical Open Collector Logic Gate

ON/OFF AND ERROR FLAG PIN

This pin has the ability to serve a dual purpose if desired. When controlled in the manner shown in Figure 1 (common in automotive systems where S1 is the ignition switch), the pin also serves as an output flag that is active low whenever a fault condition is detected with the high current regulated output. In other words, under normal operating conditions, the output voltage of this pin is high (5V). This is set by an internal clamp. If the high current output becomes unregulated for any reason (line transients, short circuit, thermal shutdown, low input voltage, etc.) the pin switches to the active low state, and is capable of sinking several milliamps. This output signal can be used to initiate any reset or start-up procedure that may be required of the system.

The ON/OFF pin can also be driven directly from open collector logic circuits. The only requirement is that the 20k pull-up resistor remain in place (Figure 5). This will not affect the logic gate since the voltage on this pin is limited by the internal clamp in the LM2935 to 5V.

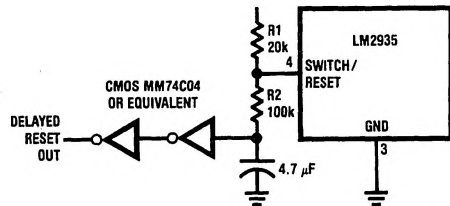

TL/H/5232-11

FIGURE 6. Reset Pulse on Power-Up (with approximately 300 ms delay)

Circuit Schematic

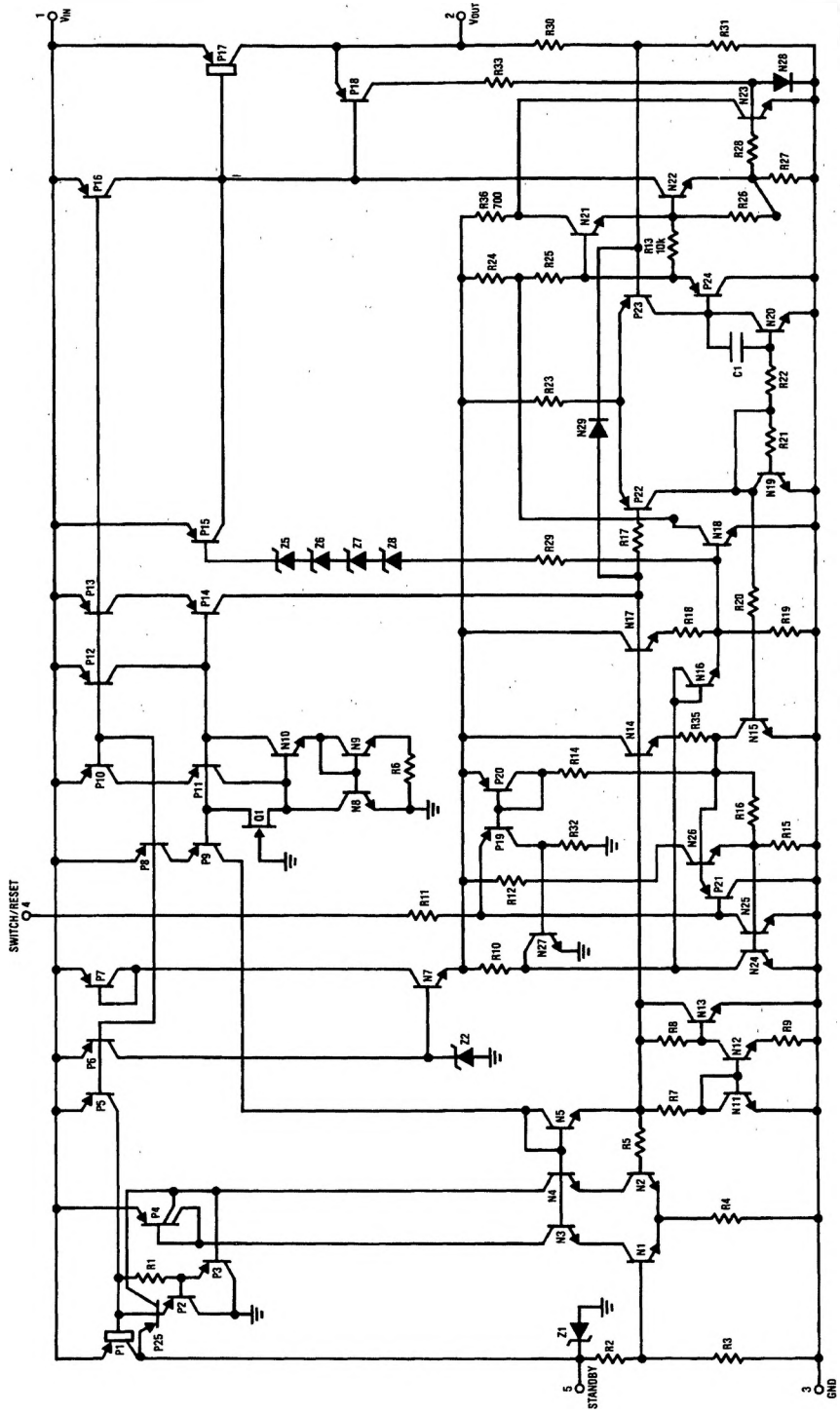

TL/H/5202-5

FIGURE 3