

LM2751 Regulated 2X, 1.5X Switched Capacitor White LED Driver

Check for Samples: [LM2751](#)

FEATURES

- Regulated Output Options: 4.5V, 5.0V
- Output Voltage Regulated Within 3%
- Peak Efficiency Over 90%
- 150mA (4.5V) or 80mA (5.0V) Output Current Capability
- Input Voltage Range: 2.8V to 5.5V
- Low Input and Output Voltage Ripple
- <math><1\mu\text{A}</math> Typical Shutdown Current
- Small Solution Size - NO INDUCTOR

- Programmable 725kHz, 300kHz, 37kHz, or 9.5kHz Switching Frequencies
- 10-pin SON No-Pullback Package: 3mm x 3mm x 0.8mm

APPLICATIONS

- White LED Display Backlights
- White LED Keypad Backlights
- General Purpose 2x, 1.5x Regulated Charge Pump

DESCRIPTION

The LM2751 is a constant frequency switched capacitor charge pump with regulated output voltage options of 4.5V, and 5.0V. Over the input voltage range of 2.8V to 5.5V the LM2751 provides up to 150mA of output current and requires only four low-cost ceramic capacitors.

The LM2751 provides excellent efficiency without the use of an inductor by operating the charge pump in a gain of 3/2 or 2. The proper gain for maintaining regulation is chosen so that efficiency is maximized over the input voltage range.

LM2751 uses constant frequency pre-regulation to minimize conducted noise on the input and provide a predictable switching frequency. The switching frequency is programmable to 725kHz, 300kHz, 37kHz, or 9.5kHz.

LM2751 is available in a 10-pin SON No-Pullback Package.

Typical Application Circuit

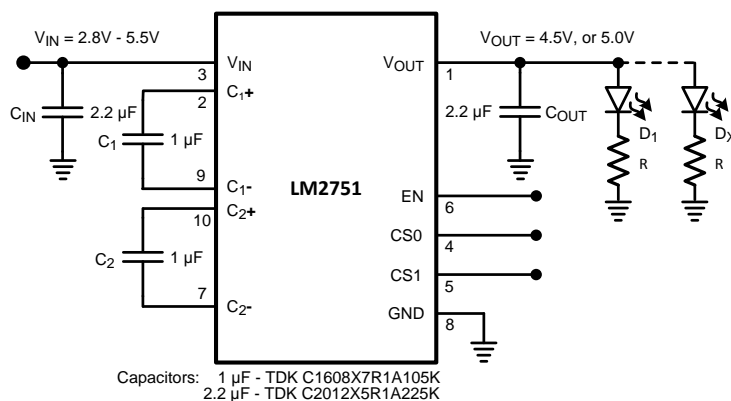

Please be aware that an important notice concerning availability, standard warranty, and use in critical applications of Texas Instruments semiconductor products and disclaimers thereto appears at the end of this data sheet.

All trademarks are the property of their respective owners.

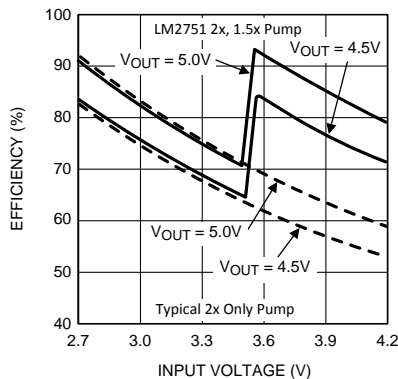

Figure 1. LM2751 2x/1.5x Efficiency vs. 2x Charge Pump Efficiency

Connection Diagram

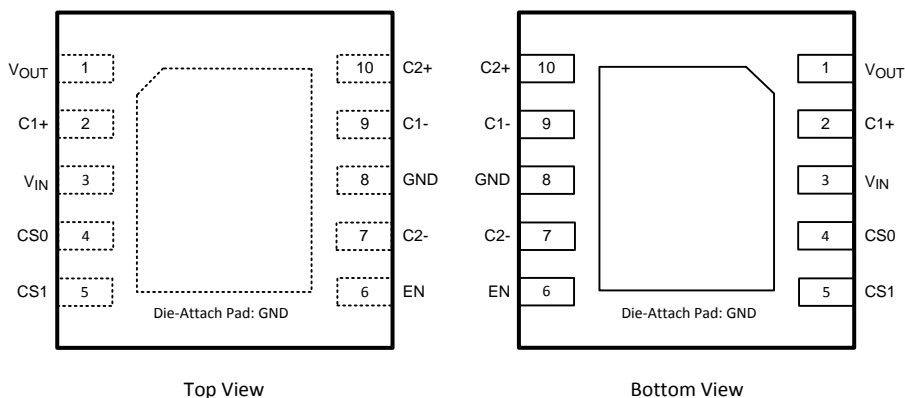

Figure 2. 10-pin SON No Pullback Package (3mm x 3mm x 0.8mm) See Package Number DSC0010A

PIN DESCRIPTIONS

Pin #	Name	Description
1	V _{OUT}	Pre-Regulated Output.
2	C ₁₊	Flying Capacitor C1 Connection.
3	V _{IN}	Input Supply Range: 2.8V to 5.5V.
4	CS0	Frequency Select Input 0.
5	CS1	Frequency Select Input 1.
6	EN	Enable Pin Logic Input.
7	C ₂₋	Flying Capacitor C2 Connection.
8	GND	Ground.
9	C ₁₋	Flying Capacitor C1 Connection.
10	C ₂₊	Flying Capacitor C2 Connection.



These devices have limited built-in ESD protection. The leads should be shorted together or the device placed in conductive foam during storage or handling to prevent electrostatic damage to the MOS gates.

Absolute Maximum Ratings^{(1) (2)(3)}

V_{IN} Pin		-0.3V to 6.0V
EN, CS0, CS1 Pins		-0.3V to ($V_{IN}+0.3$) w/ 6.0V max
Continuous Power Dissipation ⁽⁴⁾		Internally Limited
Junction Temperature ($T_{J-MAX-ABS}$)		150°C
Storage Temperature Range		-65°C to 150°C
Maximum Lead Temperature	(Soldering, 10sec.)	265°C
ESD Rating ⁽⁵⁾	Human-body model	2kV
	Machine model	200V

- (1) Absolute Maximum Ratings indicate limits beyond which damage to the component may occur. Operating Ratings are conditions under which operation of the device is guaranteed. Operating Ratings do not imply guaranteed performance limits. For guaranteed performance limits and associated test conditions, see the Electrical Characteristics tables.
- (2) All voltages are with respect to the potential at the GND pin.
- (3) If Military/Aerospace specified devices are required, please contact the Texas Instruments Sales Office/ Distributors for availability and specifications.
- (4) Internal thermal shutdown circuitry protects the device from permanent damage. Thermal shutdown engages at $T_J=150^\circ\text{C}$ (typ.) and disengages at $T_J=140^\circ\text{C}$ (typ.).
- (5) The Human body model is a 100 pF capacitor discharged through a 1.5k Ω resistor into each pin. The machine model is a 200pF capacitor discharged directly into each pin (MIL-STD-883 3015.7).

Operating Ratings^{(1) (2)}

Input Voltage Range		2.8V to 5.5V
EN, CS0, CS1 Input Voltage Range		0V to V_{IN}
Junction Temperature (T_J) Range		-40°C to 115°C
Ambient Temperature (T_A) Range ⁽³⁾		-40°C to 85°C
Recommended Maximum Load Current		
Version B	Freq. = 725kHz	150mA
	Freq. = 300kHz	120mA
	Freq. = 37kHz	40mA
	Freq. = 9.5kHz	10mA
Version A	Freq. = 725kHz	80mA
	Freq. = 300kHz	60mA
	Freq. = 37kHz	16mA
	Freq. = 9.5kHz	4mA

- (1) Absolute Maximum Ratings indicate limits beyond which damage to the component may occur. Operating Ratings are conditions under which operation of the device is guaranteed. Operating Ratings do not imply guaranteed performance limits. For guaranteed performance limits and associated test conditions, see the Electrical Characteristics tables.
- (2) All voltages are with respect to the potential at the GND pin.
- (3) In applications where high power dissipation and/or poor package thermal resistance is present, the maximum ambient temperature may have to be derated. Maximum ambient temperature (T_{A-MAX}) is dependent on the maximum operation junction temperature ($T_{J-MAX-OP} = 115^\circ\text{C}$), the maximum power dissipation of the device in the application (P_{D-MAX}), and the junction-to ambient thermal resistance of the part/package in the application (θ_{JA}), as given by the following equation:

$$T_{A-MAX} = T_{J-MAX-OP} - (\theta_{JA} \times P_{D-MAX})$$

Thermal Properties

Junction-to-Ambient Thermal Resistance, 10-pin SON	Package (θ_{JA}) ⁽¹⁾	55°C/W
--	--	--------

- (1) Junction-to-ambient thermal resistance (θ_{JA}) is taken from a thermal modeling result, performed under the conditions and guidelines set forth in the JEDEC standard JESD51-7. The test board is a 4 layer FR-4 board measuring 102mm x 76mm x 1.6mm with a 2 x 1 array of thermal vias. The ground plane on the board is 50mm x 50mm. Thickness of copper layers are 36 $\mu\text{m}/18\mu\text{m}$ /18 $\mu\text{m}/36\mu\text{m}$ (1.5oz/1oz/1oz/1.5oz). Ambient temperature in simulation is 22°C, still air. Power dissipation is 1W. The value of θ_{JA} of the LM2751 in 10-pin SON could fall in a range as wide as 50°C/W to 150°C/W (if not wider), depending on PWB material, layout, and environmental conditions. In applications where high maximum power dissipation exists (high V_{IN} , high I_{OUT}), special care must be paid to thermal dissipation issues. For more information on these topics, see the TI AN-1187 Application Report (SNOA401) and the [Power Efficiency](#) and [Power Dissipation](#) section of this datasheet.

Electrical Characteristics^{(1) (2)}

Limits in standard typeface are for $T_A = 25^\circ\text{C}$. Limits in **boldface** type apply over the full operating ambient temperature range ($-40^\circ\text{C} \leq T_A \leq +85^\circ\text{C}$). Unless otherwise noted, specifications apply to the LM2751 Typical Application Circuit (pg. 1) with: $V_{IN} = 3.6\text{V}$, $V(\text{EN}) = V_{IN}$, $\text{CS0} = \text{CS1} = V_{IN}$, $C_1 = C_2 = 1.0\mu\text{F}$, $C_{IN} = C_{OUT} = 2.2\mu\text{F}$ ⁽³⁾.

Symbol	Parameter	Conditions	Min	Typ	Max	Units
V_{OUT}	Output Voltage	Version A, $2.8\text{V} \leq V_{IN} \leq 5.5\text{V}$, Freq. = 300kHz, 725kHz, $T_A = 25^\circ\text{C}$ $I_{OUT} = 0$ to 60mA	4.850 (-3%)	5.0	5.150 (+3%)	V
		Version A, $2.8\text{V} \leq V_{IN} \leq 5.5\text{V}$, Freq. = 300kHz, $I_{OUT} = 0$ to 60mA Freq. = 725kHz, $I_{OUT} = 0$ to 80mA	4.775 (-4.5%)		5.225 (+4.5%)	
		Version B, $2.8\text{V} \leq V_{IN} \leq 5.5\text{V}$, Freq. = 300kHz, 725kHz, $T_A = 25^\circ\text{C}$ $I_{OUT} = 0$ to 120mA	4.343 (-3.5%)	4.5	4.658 (+3.5%)	
		Version B, $2.8\text{V} \leq V_{IN} \leq 5.5\text{V}$, Freq. = 300kHz, $I_{OUT} = 0$ to 120mA Freq. = 725kHz, $I_{OUT} = 0$ to 150mA	4.275 (-5%)		4.725 (+5%)	
V_R	Output Ripple	$2.8\text{V} \leq V_{IN} \leq 5.5\text{V}$ $I_{OUT} = 60\text{mA}$		8		mV
I_Q	Quiescent Current	Freq. = 9.5kHz, $I_{OUT} = 0\text{mA}$, $V_{IN} = 3.7\text{V}$		425	600	μA
		Freq. = 37kHz, $I_{OUT} = 0\text{mA}$, $V_{IN} = 3.7\text{V}$		450	640	
		Freq. = 300kHz, $I_{OUT} = 0\text{mA}$, $V_{IN} = 3.7\text{V}$		700	900	
		Freq. = 725kHz, $I_{OUT} = 0\text{mA}$, $V_{IN} = 3.7\text{V}$		1000	1500	
I_{SD}	Shutdown Supply Current	$V(\text{EN}) = 0\text{V}$		0.77	1.3	μA
		$V(\text{EN}) = 0\text{V}$, $T_A = 85^\circ\text{C}$		1.0		
E	Efficiency	$I_{OUT} = 80\text{mA}$ (Version A, 5.0V) Freq. = 300kHz, 725kHz		92		%
		$I_{OUT} = 150\text{mA}$ (Version B, 4.5V) Freq. = 300kHz, 725kHz		83		
f_{sw}	Switching Frequency	CS0 = High, CS1 = Low $2.8\text{V} \leq V_{IN} \leq 5.5\text{V}$	6.7 (-30%)	9.5	12.3 (+30%)	kHz
		CS0 = Low, CS1 = Low $2.8\text{V} \leq V_{IN} \leq 5.5\text{V}$	26 (-30%)	37	48 (+30%)	
		CS0 = Low, CS1 = High $2.8\text{V} \leq V_{IN} \leq 5.5\text{V}$	210 (-30%)	300	390 (+30%)	
		CS0 = High, CS1 = High $2.8\text{V} \leq V_{IN} \leq 5.5\text{V}$	508 (-30%)	725	942 (+30%)	
V_{IH}	Logic Input High	Input Pins: EN, CS0, CS1 $2.8\text{V} \leq V_{IN} \leq 5.5\text{V}$	1.00		V_{IN}	V
V_{IL}	Logic Input Low	Input Pins: EN, CS0, CS1 $2.8\text{V} \leq V_{IN} \leq 5.5\text{V}$	0		.30	V
I_{IH}	Logic Input High Current	Input Pins: CS0, CS1 $V(\text{CSx}) = 1.8\text{V}$		10		nA
		Input Pin: EN $V(\text{EN}) = 1.8\text{V}$ ⁽⁴⁾		2		μA
I_{IL}	Logic Input Low Current	Input Pins: EN, CS0, CS1 $V(\text{EN}, \text{CSx}) = 0\text{V}$		10		nA
V_G	Gain Transition Voltage (Version A, B)	1.5X to 2X		3.50		V
		2X to 1.5X		3.58		
		Hysteresis	40	80	150	mV
I_{SC}	Short Circuit Output Current	$V_{OUT} = 0\text{V}$		250		mA

(1) All voltages are with respect to the potential at the GND pin.

(2) Min and Max limits are guaranteed by design, test, or statistical analysis. Typical numbers are not guaranteed, but represent the most likely norm.

(3) C_{IN} , C_{OUT} , C_1 , and C_2 : Low-ESR Surface-Mount Ceramic Capacitors (MLCCs) used in setting electrical characteristics.

(4) EN Logic Input High Current (I_{IH}) is due to a $1\text{M}\Omega$ (typ.) pull-down resistor connected internally between the EN pin and GND.

Electrical Characteristics^{(1) (2) (continued)}

Limits in standard typeface are for $T_A = 25^\circ\text{C}$. Limits in **boldface** type apply over the full operating ambient temperature range ($-40^\circ\text{C} \leq T_A \leq +85^\circ\text{C}$). Unless otherwise noted, specifications apply to the LM2751 Typical Application Circuit (pg. 1) with: $V_{IN} = 3.6\text{V}$, $V(\text{EN}) = V_{IN}$, $\text{CS0} = \text{CS1} = V_{IN}$, $C_1 = C_2 = 1.0\mu\text{F}$, $C_{IN} = C_{OUT} = 2.2\mu\text{F}$ ⁽³⁾.

Symbol	Parameter	Conditions	Min	Typ	Max	Units
t_{ON}	V_{OUT} Turn-On Time ⁽⁵⁾			300		μs

(5) Turn-on time is measured from when the EN signal is pulled high until the output voltage on V_{OUT} crosses 90% of its final value.

BLOCK DIAGRAM

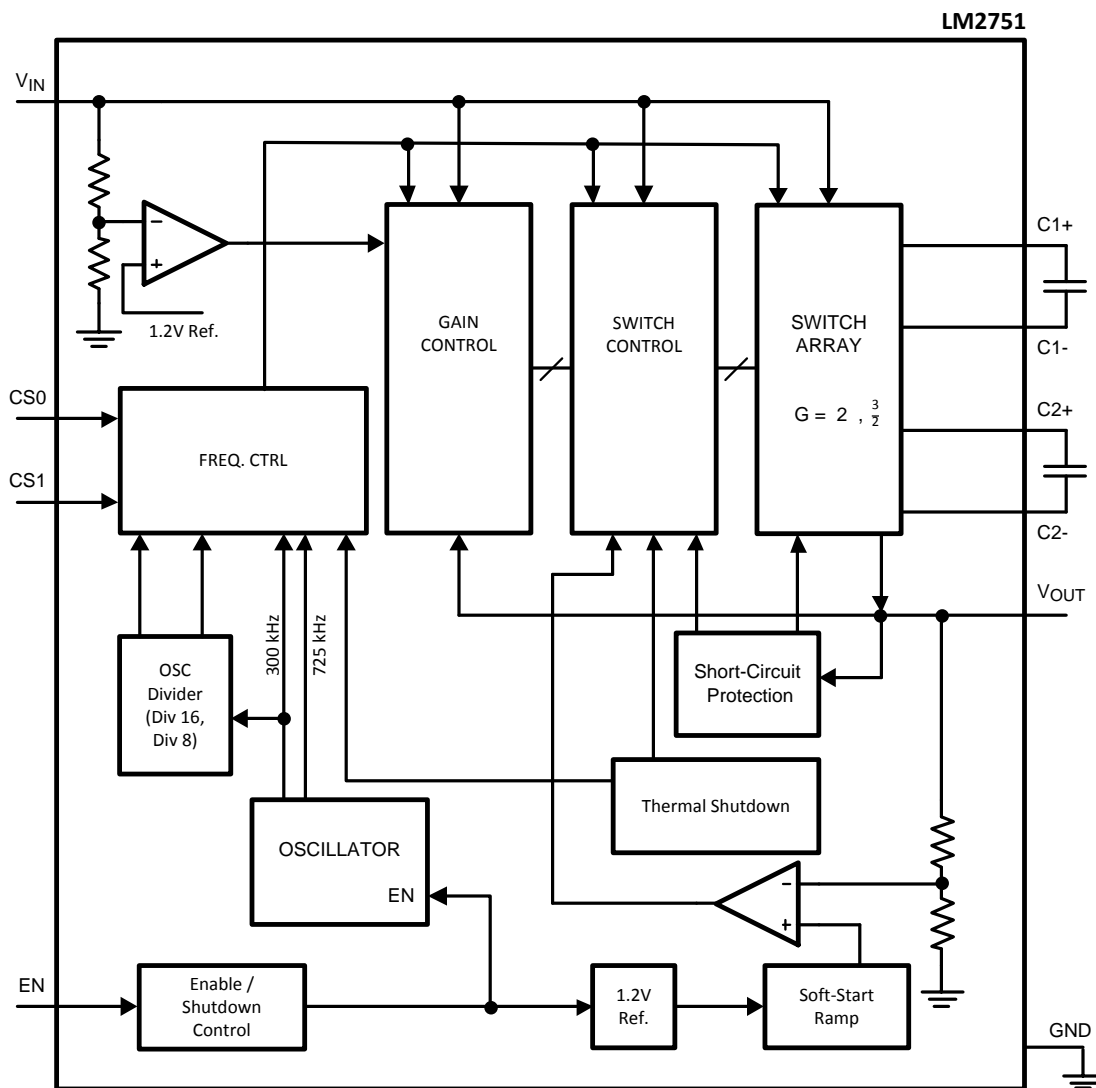

Typical Performance Characteristics

Unless otherwise specified: $T_A = 25^\circ\text{C}$, $V_{IN} = 3.6\text{V}$, $CS0 = CS1 = V_{IN}$, $V(EN) = V_{IN}$, $C_{IN} = C_{OUT} = 2.2\mu\text{F}$, $C_1 = C_2 = 1\mu\text{F}$.

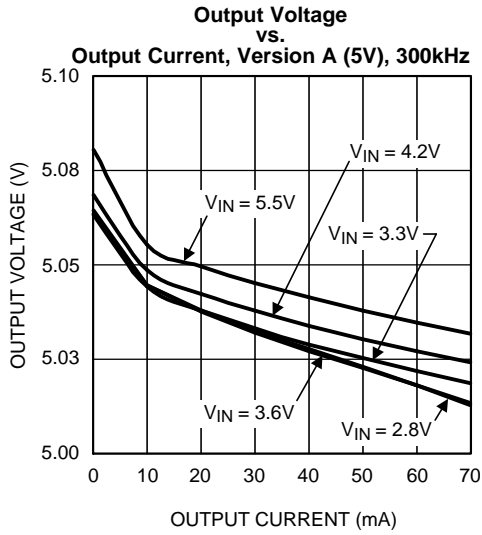

Figure 3.

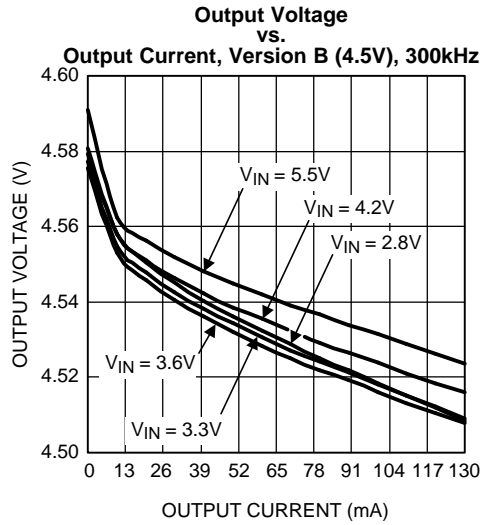

Figure 4.

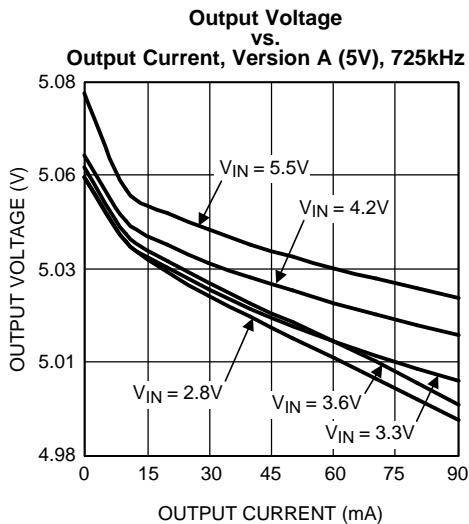

Figure 5.

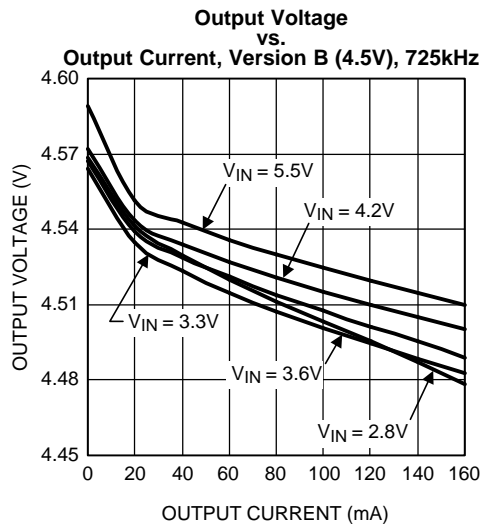
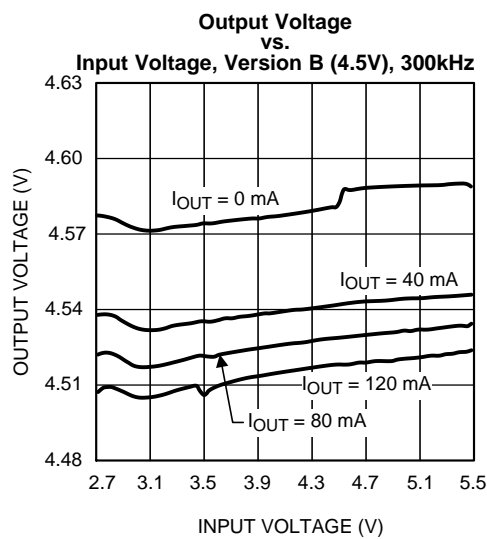
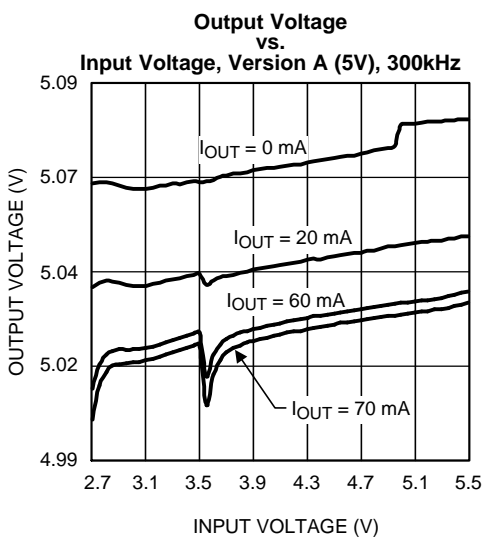
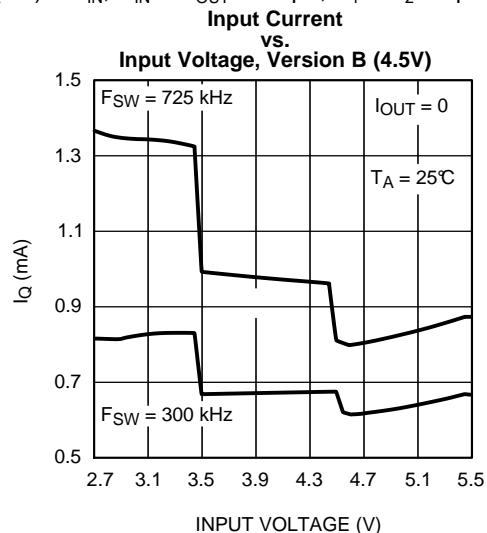
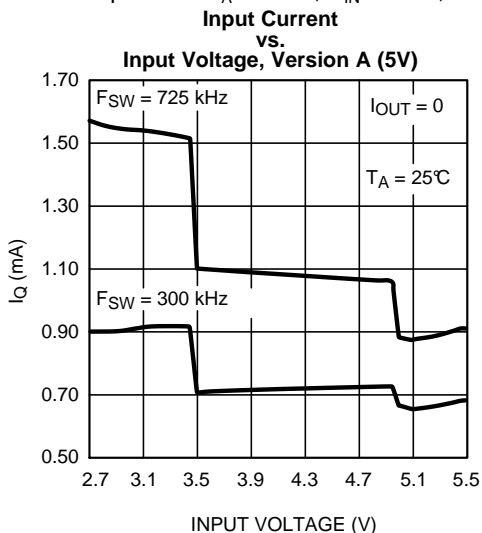

Figure 6.

Typical Performance Characteristics (continued)

Unless otherwise specified: $T_A = 25^\circ\text{C}$, $V_{IN} = 3.6\text{V}$, $CS_0 = CS_1 = V_{IN}$, $V(EN) = V_{IN}$, $C_{IN} = C_{OUT} = 2.2\mu\text{F}$, $C_1 = C_2 = 1\mu\text{F}$.



Typical Performance Characteristics (continued)

Unless otherwise specified: $T_A = 25^\circ\text{C}$, $V_{IN} = 3.6\text{V}$, $CS_0 = CS_1 = V_{IN}$, $V(EN) = V_{IN}$, $C_{IN} = C_{OUT} = 2.2\mu\text{F}$, $C_1 = C_2 = 1\mu\text{F}$.

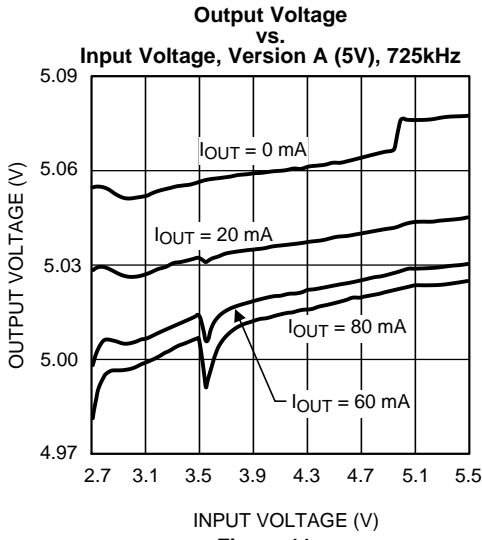

Figure 11.

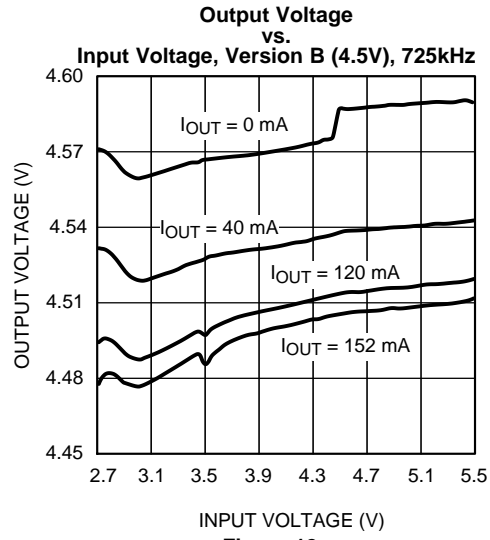

Figure 12.

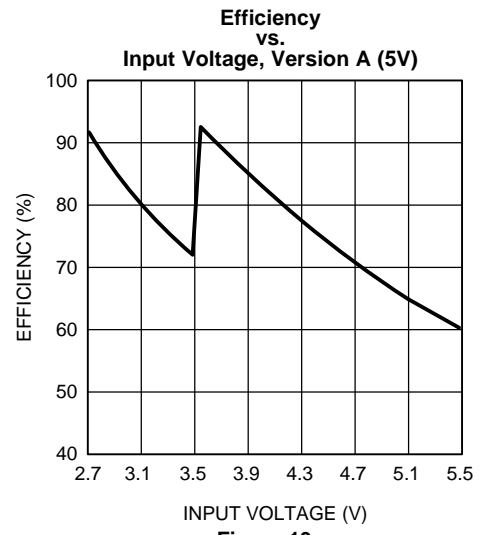

Figure 13.

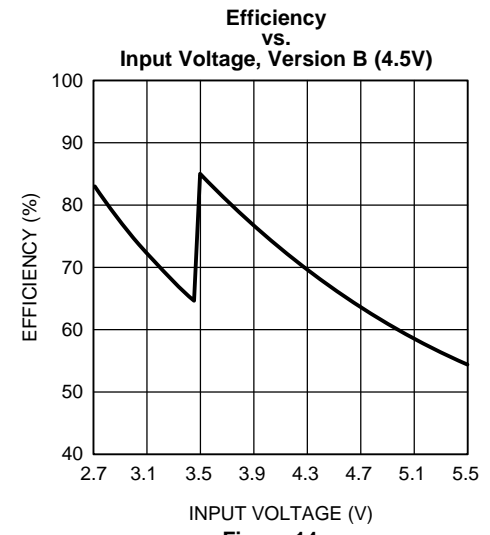

Figure 14.

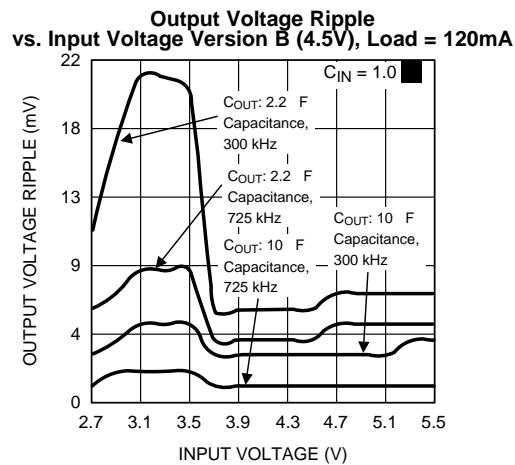
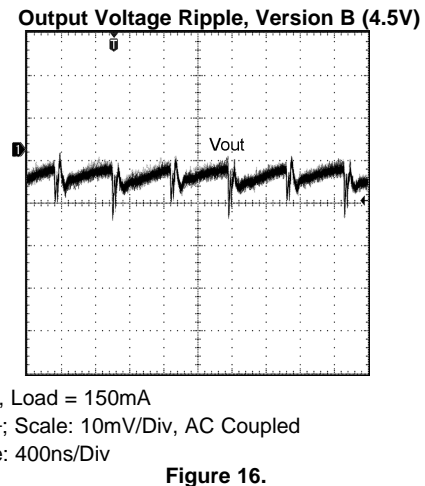

Figure 15.



$V_{IN} = 3.6\text{V}$, Load = 150mA
 CH1: V_{OUT} ; Scale: 10mV/Div, AC Coupled
 Time scale: 400ns/Div

Figure 16.

Typical Performance Characteristics (continued)

Unless otherwise specified: $T_A = 25^\circ\text{C}$, $V_{IN} = 3.6\text{V}$, $CS0 = CS1 = V_{IN}$, $V(\text{EN}) = V_{IN}$, $C_{IN} = C_{OUT} = 2.2\mu\text{F}$, $C_1 = C_2 = 1\mu\text{F}$.

Line Step Response, Version B (4.5V)

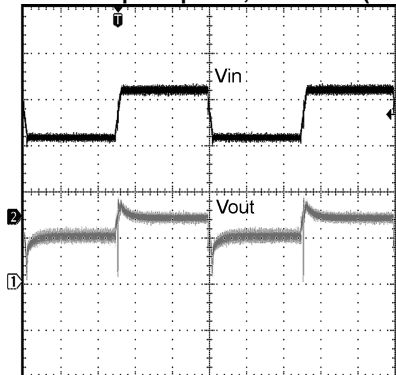

$V_{IN} = 3.2\text{V} - 4.2\text{V}$ Step, Load = 150mA
 CH1 (top): V_{IN} ; Scale: 1V/Div, DC Coupled
 CH2: V_{OUT} ; Scale: 50mV/Div, AC Coupled
 Time scale: 200 μs /Div

Figure 17.

Load Step Response, Version B (4.5V)

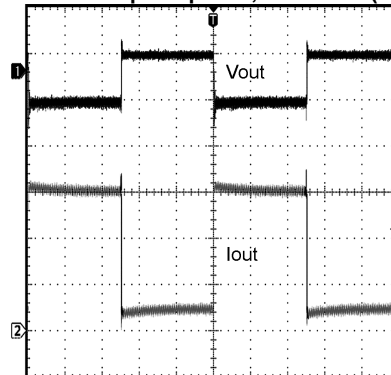

$V_{IN} = 3.6\text{V}$, Load = 20mA - 150mA Step
 CH1 (top): V_{OUT} ; Scale: 50mV/Div, AC Coupled
 CH2: Output Current; Scale: 50mA/Div
 Time scale: 200 μs /Div

Figure 18.

Start-up Behavior, Version A (5V), Load = 80mA

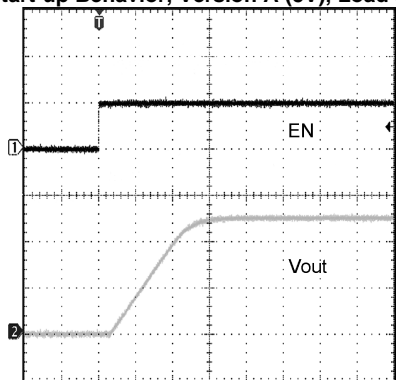

CH1: EN pin; Scale: 2V/Div
 CH2: V_{OUT} ; Scale: 2V/Div
 Time scale: 100 μs /Div

Figure 19.

Start-up Behavior, Version B (4.5V), Load = 150mA

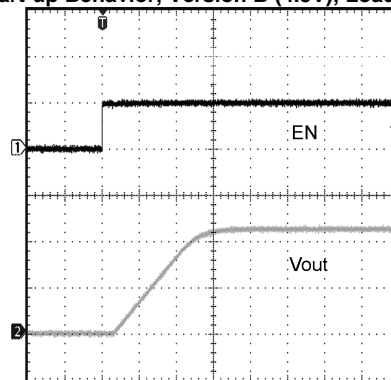

CH1: EN pin; Scale: 2V/Div
 CH2: V_{OUT} ; Scale: 2V/Div
 Time scale: 100 μs /Div

Figure 20.

APPLICATION INFORMATION

CIRCUIT DESCRIPTION

The LM2751 is a Switched Capacitor Converter with gains of 2x and 1.5x. It is capable of continuously supplying up to 150mA at 4.5V or up to 80mA at 5V depending on the output voltage option. The LM2751's fixed frequency pre-regulation maintains the output voltage to within 3% (typ.), making it well suited for driving White LEDs. There are also four user programmable switching frequencies to reduce the quiescent current consumption at light loads.

Aside from powering LEDs, the LM2751 is suitable for driving other devices with power requirements up to 150mA. The LM2751 operates over the extended Li-Ion battery range from 2.8V to 5.5V. The LM2751 limits output current to 250mA (typ.) during an output short circuit condition. LED brightness is controlled by applying a PWM (Pulse Width Modulation) signal to the Enable pin (EN). See [PWM BRIGHTNESS CONTROL](#).

SOFT START

Soft Start is engaged when the device is taken out of Shutdown mode (EN = logic HIGH) or when voltage is supplied simultaneously to the V_{IN} and EN pins. During Soft Start, the voltage on V_{OUT} will ramp up in proportion to the rate that the reference voltage is being ramped up. The output voltage is programmed to rise from 0V to the regulated output voltage level (4.5V or 5V) in 300 μ s (typ.).

ENABLE MODE

The Enable logic pin (EN) disables the part and reduces the quiescent current to 0.77 μ A (typ.). The LM2751 has an active-high enable pin (LOW = shut down, HIGH = operating) which can be driven with a low-voltage CMOS logic signal (1.5V logic, 1.8V logic, etc). There is an internal 1M Ω pull-down resistor between the EN and GND pins of the LM2751.

FREQUENCY MODE SELECT

The LM2751 switching frequency is user programmable via two logic input pins, CS0 and CS1. Both logic input pins have active-high logic (LOW = un-selected, HIGH = selected) and can be driven with a low-voltage CMOS logic signal (1.5V logic, 1.8V logic, etc). There are no internal pull-down or pull-up resistors between the CSx and GND pins of the LM2751. The CS0 and CS1 can be controlled independently or with the same logic signal.

The selectable switching frequencies are 9.5kHz, 37kHz, 300kHz, 725kHz. The switching frequency is programmed according to [Table 1](#).

Table 1. Frequency Modes

CS0	CS1	Frequency
0	0	37kHz
0	1	300kHz
1	0	9.5kHz
1	1	725kHz

V_{OUT} REGULATION

The LM2751 uses pre-regulation to regulate the output voltage to 4.5V or 5.0V depending on the voltage option. Pre-regulation uses the voltage present at V_{OUT} to limit the gate drive of the switched capacitor charge pump. This regulation is done before the voltage is gained up by the charge pump, giving rise to the term "pre-regulation". Pre-regulation helps to reduce input current noise and large input current spikes normally associated with switched capacitor charge pumps.

The LM2751 switched capacitor charge pump has gains of 2x and 1.5x. When the input voltage to the device is greater than 3.58V (typ.), the LM2751 operates in a gain of 1.5x. When the input voltage falls below 3.5V (typ.), the device switches to a gain of 2x.

OUTPUT VOLTAGE RIPPLE

The primary contributor in keeping the output voltage ripple of the LM2751 low is its switching topology. The output capacitance, input voltage, switching frequency and output current also play a significant part in determining the output voltage ripple. Due to the complexity of the LM2751 operation, providing equations or models to approximate the magnitude of the ripple cannot be easily accomplished. However, the following general statements can be made.

The LM2751 has very low output ripple when compared to typical boost regulators due to its double-pump topology, where charge is continually supplied to the output during both 2x and 1.5x modes. Combined with fixed frequency operation modes, double-pumping allows for the use of a very small, low value ceramic capacitor on the output node while still achieving minimal output ripple. Increasing the capacitance by adding a higher value capacitor or placing multiple capacitors in parallel can further reduce the ripple magnitude.

CAPACITOR SELECTION

The LM2751 requires 4 external capacitors for proper operation. Surface-mount multi-layer ceramic capacitors are recommended. These capacitors are small, inexpensive and have very low equivalent series resistance (ESR, $\leq 15\text{m}\Omega$ typ.). Tantalum capacitors, OS-CON capacitors, and aluminum electrolytic capacitors are generally not recommended for use with the LM2751 due to their high ESR, as compared to ceramic capacitors.

For most applications, ceramic capacitors with X7R or X5R temperature characteristic are preferred for use with the LM2751. These capacitors have tight capacitance tolerance (as good as $\pm 10\%$), hold their value over temperature (X7R: $\pm 15\%$ over -55°C to 125°C ; X5R: $\pm 15\%$ over -55°C to 85°C), and typically have little voltage coefficient when compared to other types of capacitors. However selecting a capacitor with a voltage rating much higher than the voltage it will be subjected to, will ensure that the capacitance will stay closer to the capacitor's nominal value. Capacitors with Y5V or Z5U temperature characteristic are generally not recommended for use with the LM2751. Capacitors with these temperature characteristics typically have wide capacitance tolerance ($+80\%$, -20%), vary significantly over temperature (Y5V: $+22\%$, -82% over -30°C to $+85^\circ\text{C}$ range; Z5U: $+22\%$, -56% over $+10^\circ\text{C}$ to $+85^\circ\text{C}$ range), and have poor voltage coefficients. Under some conditions, a nominal $1\mu\text{F}$ Y5V or Z5U capacitor could have a capacitance of only $0.1\mu\text{F}$. Such detrimental deviation is likely to cause Y5V and Z5U capacitors to fail to meet the minimum capacitance requirements of the LM2751.

The voltage rating of the output capacitor should be 10V or more. All other capacitors should have a voltage rating at or above the maximum input voltage of the application.

DRIVING WHITE LEDs

The desired LED current is set by placing a resistor (R) in series with each LED, and is determined by the equation:

$$I_{\text{LED}} = (V_{\text{OUT}} - V_{\text{LED}}) \div R \quad (1)$$

In the equation above, I_{LED} is the current that flows through a particular LED, and V_{LED} is the forward voltage of the LED at the given current. The output voltage (V_{OUT}) of the LM2751 is tightly regulated to 4.5V or 5V depending on the output voltage option. However, LED forward voltage varies from LED to LED, and LED current will vary accordingly. Mismatch of LED currents will result in brightness mismatch from one LED to the next. Therefore it is suggested that LED groups with tightly controlled I-V characteristics ("Binned" LEDs) be used. LEDs with looser tolerance can be used in applications where brightness matching is not critical, such as in keypad or general backlighting. The typical and maximum diode forward voltage depends highly on the manufacturer and their technology.

PWM BRIGHTNESS CONTROL

Perceived LED brightness can be adjusted using a PWM control signal on the Enable pin of the LM2751, to turn the voltage output ON and OFF at a rate faster than perceptible by the eye. When this is done, the total brightness perceived is proportional to the duty cycle (D) of the PWM signal (D = the percentage of time that the LED is on in every PWM cycle). A simple example: if the LEDs are driven at 15mA each with a PWM signal that has a 50% duty cycle, perceived LED brightness will be about half as bright as compared to when the LEDs are driven continuously with 15mA.

For linear brightness control over the full duty cycle adjustment range, the PWM frequency (f) should be limited to accommodate the turn-on time (typ. $T_{ON} = 300\mu s$) of the device.

$$D \times (1/f) > T_{ON} \quad (2)$$

$$f_{MAX} = D_{MIN} \div T_{ON} \quad (3)$$

The minimum recommended PWM frequency is 100Hz. Frequencies below this may be visibly noticeable as flicker or blinking. The maximum recommended PWM frequency is 1kHz. Frequencies above this may cause noise in the audible range.

THERMAL PROTECTION

When the junction temperature exceeds 150°C (typ.), internal thermal protection circuitry disables the device. This feature protects the LM2751 from damage due to excessive power dissipation. The device will recover and operate normally when the junction temperature falls below 140°C (typ.). It is important to have good thermal conduction with a proper layout to reduce thermal resistance.

POWER EFFICIENCY

Charge-Pump efficiency is derived in the following two ideal equations (supply current and other losses are neglected for simplicity):

$$I_{IN} = G \times I_{OUT} \quad (4)$$

$$E = (V_{OUT} \times I_{OUT}) \div (V_{IN} \times I_{IN}) = V_{OUT} \div (G \times V_{IN}) \quad (5)$$

In the equations, G represents the charge pump gain. Efficiency is at its highest as $G \times V_{IN}$ approaches V_{OUT} . Refer to the efficiency graph in the [Typical Performance Characteristics](#) for the detailed efficiency data.

POWER DISSIPATION

The power dissipation ($P_{DISSIPATION}$) and junction temperature (T_J) can be approximated with the equations below. P_{IN} is the product of the input current and input voltage, P_{OUT} is the power consumed by the load connected to the output, T_A is the ambient temperature, and θ_{JA} is the junction-to-ambient thermal resistance for the 10-pin SON package. V_{IN} is the input voltage to the LM2751, V_{VOUT} is the voltage at the output of the device, and I_{OUT} is the total current supplied to the load connected to V_{OUT} .

$$P_{DISSIPATION} = P_{IN} - P_{OUT} \quad (6)$$

$$= (V_{IN} \times I_{IN}) - (V_{VOUT} \times I_{OUT}) \quad (7)$$

$$T_J = T_A + (P_{DISSIPATION} \times \theta_{JA}) \quad (8)$$

The junction temperature rating takes precedence over the ambient temperature rating. The LM2751 may be operated outside the ambient temperature rating, so long as the junction temperature of the device does not exceed the maximum operating rating of 115°C. The maximum ambient temperature rating must be derated in applications where high power dissipation and/or poor thermal resistance causes the junction temperature to exceed 115°C.

PACKAGING INFORMATION

Orderable Device	Status (1)	Package Type	Package Drawing	Pins	Package Qty	Eco Plan (2)	Lead/Ball Finish	MSL Peak Temp (3)	Op Temp (°C)	Top-Side Markings (4)	Samples
LM2751SD-A	ACTIVE	WSON	DSC	10	1000	TBD	Call TI	Call TI	-40 to 85	L145B	Samples
LM2751SD-A/NOPB	ACTIVE	WSON	DSC	10	1000	Green (RoHS & no Sb/Br)	CU SN	Level-1-260C-UNLIM	-40 to 85	L145B	Samples
LM2751SD-B	ACTIVE	WSON	DSC	10	1000	TBD	Call TI	Call TI	-40 to 85	L146B	Samples
LM2751SD-B/NOPB	ACTIVE	WSON	DSC	10	1000	Green (RoHS & no Sb/Br)	CU SN	Level-1-260C-UNLIM	-40 to 85	L146B	Samples
LM2751SDX-A	ACTIVE	WSON	DSC	10	4500	TBD	Call TI	Call TI	-40 to 85	L145B	Samples
LM2751SDX-A/NOPB	ACTIVE	WSON	DSC	10	4500	Green (RoHS & no Sb/Br)	CU SN	Level-1-260C-UNLIM	-40 to 85	L145B	Samples
LM2751SDX-B	ACTIVE	WSON	DSC	10	4500	TBD	Call TI	Call TI	-40 to 85	L146B	Samples
LM2751SDX-B/NOPB	ACTIVE	WSON	DSC	10	4500	Green (RoHS & no Sb/Br)	CU SN	Level-1-260C-UNLIM	-40 to 85	L146B	Samples

(1) The marketing status values are defined as follows:

ACTIVE: Product device recommended for new designs.

LIFEBUY: TI has announced that the device will be discontinued, and a lifetime-buy period is in effect.

NRND: Not recommended for new designs. Device is in production to support existing customers, but TI does not recommend using this part in a new design.

PREVIEW: Device has been announced but is not in production. Samples may or may not be available.

OBSOLETE: TI has discontinued the production of the device.

(2) Eco Plan - The planned eco-friendly classification: Pb-Free (RoHS), Pb-Free (RoHS Exempt), or Green (RoHS & no Sb/Br) - please check <http://www.ti.com/productcontent> for the latest availability information and additional product content details.

TBD: The Pb-Free/Green conversion plan has not been defined.

Pb-Free (RoHS): TI's terms "Lead-Free" or "Pb-Free" mean semiconductor products that are compatible with the current RoHS requirements for all 6 substances, including the requirement that lead not exceed 0.1% by weight in homogeneous materials. Where designed to be soldered at high temperatures, TI Pb-Free products are suitable for use in specified lead-free processes.

Pb-Free (RoHS Exempt): This component has a RoHS exemption for either 1) lead-based flip-chip solder bumps used between the die and package, or 2) lead-based die adhesive used between the die and leadframe. The component is otherwise considered Pb-Free (RoHS compatible) as defined above.

Green (RoHS & no Sb/Br): TI defines "Green" to mean Pb-Free (RoHS compatible), and free of Bromine (Br) and Antimony (Sb) based flame retardants (Br or Sb do not exceed 0.1% by weight in homogeneous material)

(3) MSL, Peak Temp. -- The Moisture Sensitivity Level rating according to the JEDEC industry standard classifications, and peak solder temperature.

(4) Only one of markings shown within the brackets will appear on the physical device.

Important Information and Disclaimer: The information provided on this page represents TI's knowledge and belief as of the date that it is provided. TI bases its knowledge and belief on information provided by third parties, and makes no representation or warranty as to the accuracy of such information. Efforts are underway to better integrate information from third parties. TI has taken and continues to take reasonable steps to provide representative and accurate information but may not have conducted destructive testing or chemical analysis on incoming materials and chemicals. TI and TI suppliers consider certain information to be proprietary, and thus CAS numbers and other limited information may not be available for release.

In no event shall TI's liability arising out of such information exceed the total purchase price of the TI part(s) at issue in this document sold by TI to Customer on an annual basis.

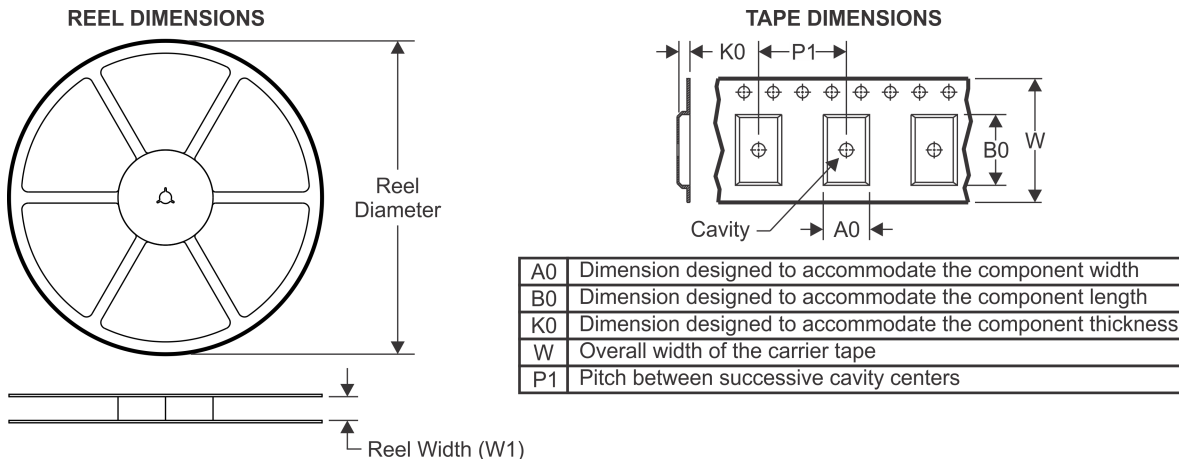
TAPE AND REEL INFORMATION

QUADRANT ASSIGNMENTS FOR PIN 1 ORIENTATION IN TAPE

*All dimensions are nominal

Device	Package Type	Package Drawing	Pins	SPQ	Reel Diameter (mm)	Reel Width W1 (mm)	A0 (mm)	B0 (mm)	K0 (mm)	P1 (mm)	W (mm)	Pin1 Quadrant
LM2751SD-A	SON	DSC	10	1000	178.0	12.4	3.3	3.3	1.0	8.0	12.0	Q1
LM2751SD-A/NOPB	SON	DSC	10	1000	178.0	12.4	3.3	3.3	1.0	8.0	12.0	Q1
LM2751SD-B	SON	DSC	10	1000	178.0	12.4	3.3	3.3	1.0	8.0	12.0	Q1
LM2751SD-B/NOPB	SON	DSC	10	1000	178.0	12.4	3.3	3.3	1.0	8.0	12.0	Q1
LM2751SDX-A	SON	DSC	10	4500	330.0	12.4	3.3	3.3	1.0	8.0	12.0	Q1
LM2751SDX-A/NOPB	SON	DSC	10	4500	330.0	12.4	3.3	3.3	1.0	8.0	12.0	Q1
LM2751SDX-B	SON	DSC	10	4500	330.0	12.4	3.3	3.3	1.0	8.0	12.0	Q1
LM2751SDX-B/NOPB	SON	DSC	10	4500	330.0	12.4	3.3	3.3	1.0	8.0	12.0	Q1

TAPE AND REEL BOX DIMENSIONS



*All dimensions are nominal

Device	Package Type	Package Drawing	Pins	SPQ	Length (mm)	Width (mm)	Height (mm)
LM2751SD-A	SON	DSC	10	1000	203.0	190.0	41.0
LM2751SD-A/NOPB	SON	DSC	10	1000	203.0	190.0	41.0
LM2751SD-B	SON	DSC	10	1000	203.0	190.0	41.0
LM2751SD-B/NOPB	SON	DSC	10	1000	203.0	190.0	41.0
LM2751SDX-A	SON	DSC	10	4500	349.0	337.0	45.0
LM2751SDX-A/NOPB	SON	DSC	10	4500	349.0	337.0	45.0
LM2751SDX-B	SON	DSC	10	4500	349.0	337.0	45.0
LM2751SDX-B/NOPB	SON	DSC	10	4500	349.0	337.0	45.0

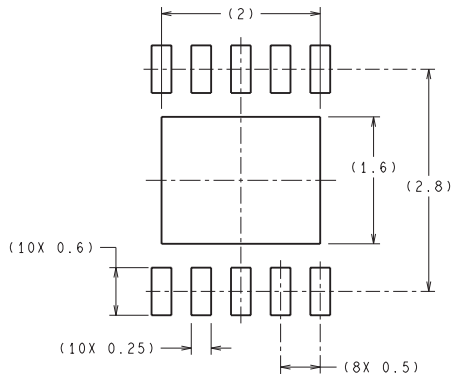
DSC0010A

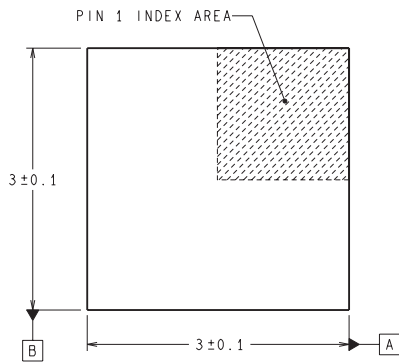

RECOMMENDED LAND PATTERN



DIMENSIONS ARE IN MILLIMETERS
DIMENSIONS IN () FOR REFERENCE ONLY

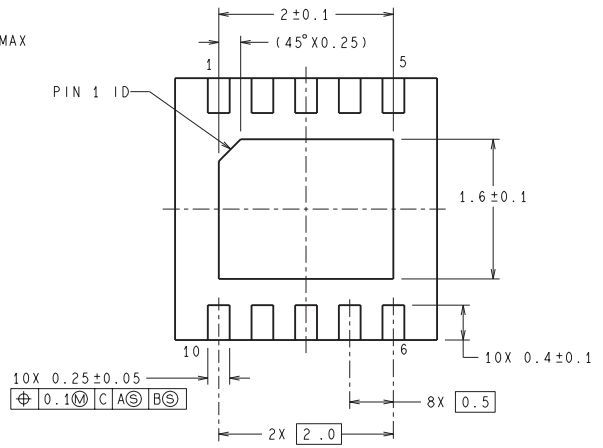
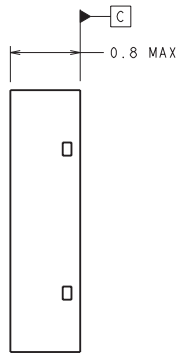
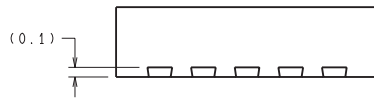

SDA10A (Rev A)

IMPORTANT NOTICE

Texas Instruments Incorporated and its subsidiaries (TI) reserve the right to make corrections, enhancements, improvements and other changes to its semiconductor products and services per JESD46, latest issue, and to discontinue any product or service per JESD48, latest issue. Buyers should obtain the latest relevant information before placing orders and should verify that such information is current and complete. All semiconductor products (also referred to herein as "components") are sold subject to TI's terms and conditions of sale supplied at the time of order acknowledgment.

TI warrants performance of its components to the specifications applicable at the time of sale, in accordance with the warranty in TI's terms and conditions of sale of semiconductor products. Testing and other quality control techniques are used to the extent TI deems necessary to support this warranty. Except where mandated by applicable law, testing of all parameters of each component is not necessarily performed.

TI assumes no liability for applications assistance or the design of Buyers' products. Buyers are responsible for their products and applications using TI components. To minimize the risks associated with Buyers' products and applications, Buyers should provide adequate design and operating safeguards.

TI does not warrant or represent that any license, either express or implied, is granted under any patent right, copyright, mask work right, or other intellectual property right relating to any combination, machine, or process in which TI components or services are used. Information published by TI regarding third-party products or services does not constitute a license to use such products or services or a warranty or endorsement thereof. Use of such information may require a license from a third party under the patents or other intellectual property of the third party, or a license from TI under the patents or other intellectual property of TI.

Reproduction of significant portions of TI information in TI data books or data sheets is permissible only if reproduction is without alteration and is accompanied by all associated warranties, conditions, limitations, and notices. TI is not responsible or liable for such altered documentation. Information of third parties may be subject to additional restrictions.

Resale of TI components or services with statements different from or beyond the parameters stated by TI for that component or service voids all express and any implied warranties for the associated TI component or service and is an unfair and deceptive business practice. TI is not responsible or liable for any such statements.

Buyer acknowledges and agrees that it is solely responsible for compliance with all legal, regulatory and safety-related requirements concerning its products, and any use of TI components in its applications, notwithstanding any applications-related information or support that may be provided by TI. Buyer represents and agrees that it has all the necessary expertise to create and implement safeguards which anticipate dangerous consequences of failures, monitor failures and their consequences, lessen the likelihood of failures that might cause harm and take appropriate remedial actions. Buyer will fully indemnify TI and its representatives against any damages arising out of the use of any TI components in safety-critical applications.

In some cases, TI components may be promoted specifically to facilitate safety-related applications. With such components, TI's goal is to help enable customers to design and create their own end-product solutions that meet applicable functional safety standards and requirements. Nonetheless, such components are subject to these terms.

No TI components are authorized for use in FDA Class III (or similar life-critical medical equipment) unless authorized officers of the parties have executed a special agreement specifically governing such use.

Only those TI components which TI has specifically designated as military grade or "enhanced plastic" are designed and intended for use in military/aerospace applications or environments. Buyer acknowledges and agrees that any military or aerospace use of TI components which have **not** been so designated is solely at the Buyer's risk, and that Buyer is solely responsible for compliance with all legal and regulatory requirements in connection with such use.

TI has specifically designated certain components as meeting ISO/TS16949 requirements, mainly for automotive use. In any case of use of non-designated products, TI will not be responsible for any failure to meet ISO/TS16949.

Products

Audio	www.ti.com/audio
Amplifiers	amplifier.ti.com
Data Converters	dataconverter.ti.com
DLP® Products	www.dlp.com
DSP	dsp.ti.com
Clocks and Timers	www.ti.com/clocks
Interface	interface.ti.com
Logic	logic.ti.com
Power Mgmt	power.ti.com
Microcontrollers	microcontroller.ti.com
RFID	www.ti-rfid.com
OMAP Applications Processors	www.ti.com/omap
Wireless Connectivity	www.ti.com/wirelessconnectivity

Applications

Automotive and Transportation	www.ti.com/automotive
Communications and Telecom	www.ti.com/communications
Computers and Peripherals	www.ti.com/computers
Consumer Electronics	www.ti.com/consumer-apps
Energy and Lighting	www.ti.com/energy
Industrial	www.ti.com/industrial
Medical	www.ti.com/medical
Security	www.ti.com/security
Space, Avionics and Defense	www.ti.com/space-avionics-defense
Video and Imaging	www.ti.com/video

TI E2E Community

e2e.ti.com