

## LM26484 Power Management Unit

Check for Samples: [LM26484](#)

### FEATURES

- **STEP-DOWN DC/DC CONVERTER (BUCK)**
    - 3.0–5.5V Input Range
    - Externally Adjustable  $V_{OUT}$ :
    - Bucks 1 & 2: 0.8V–3.5V @ 2A
    - 180° Phase Shift Between Bucks Clocks
    - 2 MHz PWM Switching Frequency
    - $\pm 1\%$  feedback Voltage Accuracy
    - Automatic Soft Start
    - Current Overload Protection
    - PWM/PFM efficiency Modes Available
  - **LINEAR REGULATOR (LDO) CONTROLLER**
    - 3.0V–5.5V Input Range
    - Externally Adjustable  $V_{OUT}$
    - $\pm 1.5\%$  Feedback Voltage Accuracy
- Regulated to Low  $V_{IN}$  - Low  $V_{OUT}$  LI-LO (Low Input Low Output) NFET Operation
  - Input to the LI-LO Configuration, Can Be Post Regulated When Supply is Regulated by Buck2
  - Up to 1000 mA Output Current by Selection of External FET

### APPLICATIONS

- Digital Cores and I/Os (FPGAs, ASICs, DSPs)
- Automotive Infotainment
- Set-Top-Box
- Cordless Phone Base Station
- Networking Router
- Printers

### DESCRIPTION

The LM26484 is a multi-function, configurable Power Management Unit. This device integrates two highly efficient 2.0A Step-Down DC/DC converters, one LDO Controller, a POR (Power On Reset) circuit, and thermal overload protection circuitry. All regulator output voltages are externally adjustable. The LDO controller is a low-voltage NMOS voltage regulator. The LM26484 is offered in a 5 x 4 x 0.8 mm WQFN-24 pin package.



Please be aware that an important notice concerning availability, standard warranty, and use in critical applications of Texas Instruments semiconductor products and disclaimers thereto appears at the end of this data sheet.

All trademarks are the property of their respective owners.

### Typical Application Circuit

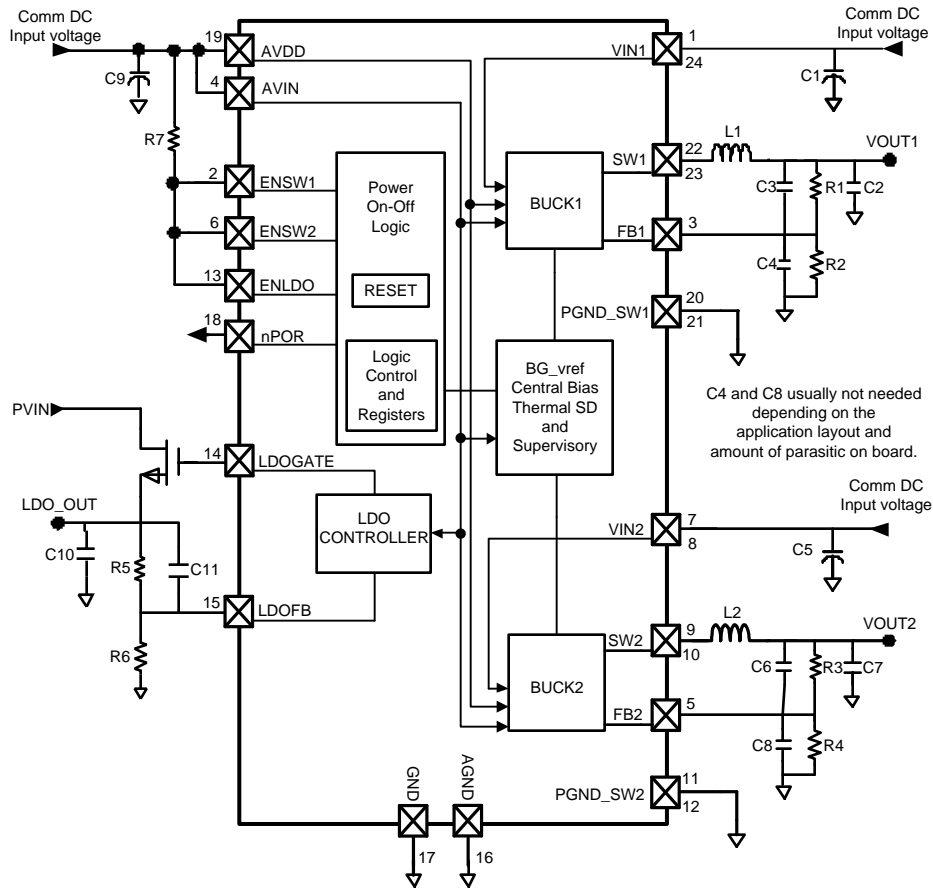

### Connection Diagram

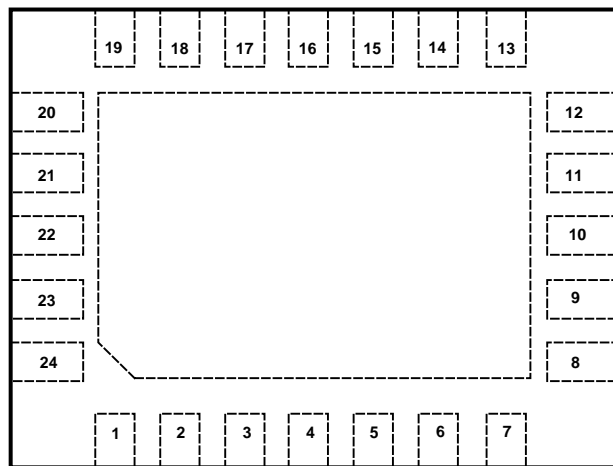

Figure 1. 24-Lead WQFN Package (top view)  
Package NHZ0024B

**PIN DESCRIPTIONS**

Pins	Name	I/O	Type <sup>(1)</sup>	Description
1	VIN1	I	PWR	Power in DC source Buck1 PMOS
2	ENSW1	I	D	Enable for Buck1 switcher, a logic HIGH enables Buck1
3	FB1	I	A	Buck1 input feedback terminal
4	AVIN	I	PWR	Analog power for internal circuits
5	FB2	I	A	Buck2 input feedback terminal
6	ENSW2	I	D	Enable for Buck2 switcher, a logic HIGH enables Buck2
7	VIN2	I	PWR	Power in DC source Buck2 PMOS
8	VIN2	I	PWR	Power in DC source Buck2 PMOS
9	SW2	O	A	Buck2 switcher output
10	SW2	O	A	Buck2 switcher output
11	PGND_SW2	G	G	Buck2 NMOS Power Ground
12	PGND_SW2	G	G	Buck2 NMOS Power Ground
13	ENLDO	I	D	Enable for LDO, a logic HIGH enables LDO
14	LDOGATE	O	A	LDO Controller output to NMOS power transistor Gate
15	LDOFB	I	A	LDO Controller input to feedback terminal
16	AGND	G	G	Analog GND
17	GND	G	G	Ground
18	nPOR	O	D	nPOR Active low Reset output. nPOR remains LOW while the input supply is below threshold, and goes HIGH after the threshold is reached and timed delay
19	AVDD	I	PWR	Analog Power Pin
20	PGND_SW1	G	G	Buck1 NMOS Power Ground
21	PGND_SW1	G	G	Buck1 NMOS Power Ground
22	SW1	O	A	Buck1 switcher output
23	SW1	O	A	Buck1 switcher output
24	VIN1	I	PWR	Power in DC source Buck1 PMOS
DAP	DAP	GND	GND	Connection isn't necessary for electrical performance, but it is recommended for better thermal dissipation.

(1) **A:** Analog Pin    **D:** Digital Pin    **G:** Ground Pin    **PWR:** Power Pin



These devices have limited built-in ESD protection. The leads should be shorted together or the device placed in conductive foam during storage or handling to prevent electrostatic damage to the MOS gates.

**Absolute Maximum Ratings**<sup>(1)(2)(3)</sup>

VIN1, VIN2, AVDD, AVIN	-0.3V to +6V
nPOR, ENSW1, FB1, ENSW2, FB2, ENLDO, LDO_FB	-0.3 to VIN + 0.3V
GND to GND SLUG	±0.3V
Junction Temperature (T <sub>J-MAX</sub> )	150°C
Storage Temperature Range	-65°C to +150°C
Maximum Lead Temperature (Soldering)	260°C
<b>ESD Ratings</b>	
Human Body Model <sup>(4)</sup>	2 kV
Machine Model: VIN1,2; SW1,2 PGND1,2 All other pins	150V 200V

- (1) Absolute Maximum Ratings indicate limits beyond which damage to the component may occur. Operating Ratings are conditions under which operation of the device is guaranteed. Operating Ratings do not imply guaranteed performance limits. For guaranteed performance limits and associated test conditions, see the Electrical Characteristics tables.
- (2) All voltages are with respect to the potential at the GND pin.
- (3) If Military/Aerospace specified devices are required, please contact the TI Sales Office/Distributors for availability and specifications.
- (4) The Human body model is a 100 pF capacitor discharged through a 1.5 kΩ resistor into each pin. The machine model is a 200 pF capacitor discharged directly into each pin. (MILSTD - 883 3015.7)

**Operating Ratings**

VIN1, VIN2, AVDD, AVIN	3.0V to 5.5V
nPOR, ENSW1, ENSW2, ENLDO, LDO_GATE, SW1, SW2	0V to V <sub>IN</sub> + 0.3V
FB1, FB2	0v to VBuck1 and VBuck2 respectively
LDOFB	0v to V <sub>LDO</sub>
Power Dissipation (P <sub>D-MAX</sub> ) T <sub>A</sub> = 85°C, T <sub>MAX</sub> = 125°C	1.2W
Junction Temperature (T <sub>J</sub> ) Range <sup>(1)</sup>	-40°C to +125°C

- (1) Internal thermal shutdown circuitry protects the device from permanent damage. Thermal shutdown engages at T<sub>J</sub> = 160°C (typ.) and disengages at T<sub>J</sub> = 130°C (typ.)

**Thermal Properties**<sup>(1) (2)</sup>

Junction-to-Ambient Thermal Resistance (θ <sub>JA</sub> )	33.1°C/W based on a 4-layer 1 oz. PCB
Junction-to-Case Thermal Resistance (θ <sub>JC</sub> )	4.3°C/W

- (1) In applications where high power dissipation and/or poor package thermal resistance is present, the maximum ambient temperature may have to be derated. Maximum ambient temperature (T<sub>A-MAX</sub>) is dependent on the maximum operating junction temperature, the maximum power dissipation of the device in the application (P<sub>D-MAX</sub>), and the junction-to-ambient thermal resistance of the package in the application (θ<sub>JA</sub>), as given by the following equation: T<sub>A-MAX</sub> = T<sub>J-MAX</sub> - (θ<sub>JA</sub> × P<sub>D-MAX</sub>). Refer to dissipation rating table for P<sub>D-MAX</sub> values at different ambient temperatures.
- (2) Junction-to-ambient thermal resistance is highly application and board-layout dependent. In applications where high maximum power dissipation exists, special care must be paid to thermal dissipation issues in board design. More information is available in National Semiconductor Application Note AN1187.

## General Electrical Characteristics<sup>(1)</sup>

Typical values and limits appearing in normal type apply for  $T_J = 25^\circ\text{C}$ . Limits appearing in **boldface type** apply over the entire junction temperature range for operation,  $-40^\circ\text{C}$  to  $+125^\circ\text{C}$ .<sup>(2) (3)</sup>

Symbol	Parameter	Conditions	Min	Typ	Max	Units
$V_{IN}$	Operational Voltage Range	AVDD, AVIN	<b>3.0</b>	3.3	<b>5.5</b>	V
$T_{SD}$	Thermal Shutdown	<sup>(4)</sup>		160		$^\circ\text{C}$
$C_{IN}$	Input Capacitor	C9 (Typ App Circuit)		10		$\mu\text{F}$
$I_q$	Quiescent Current "Off"	$V_{IN} = 3.3\text{V}$ , ENSW1, ENSW2, ENLDO = 0		0.03	1	$\mu\text{A}$

(1) This specification is guaranteed by design.

(2) All voltages are with respect to the potential at the GND pin.

(3) Min and Max limits are guaranteed by design, test, or statistical analysis. Typical numbers are not guaranteed, but do represent the most likely norm.

(4) Internal thermal shutdown circuitry protects the device from permanent damage. Thermal shutdown engages at  $T_J = 160^\circ\text{C}$  (typ.) and disengages at  $T_J = 130^\circ\text{C}$  (typ.)

## LDO Controller

Unless otherwise noted, AVDD = AVIN 3.3V, PVIN = 1.8V. Typical values and limits appearing in normal type apply for  $T_A = 25^\circ\text{C}$ . Limits appearing in **boldface type** apply over the entire junction temperature range for operation,  $-40^\circ\text{C}$  to  $+125^\circ\text{C}$ .<sup>(1)</sup>

Symbol	Parameter	Conditions	Min	Typ	Max	Units
$V_{IN}$	Operational Voltage Range	AVIN LDO internal circuits	<b>3.0</b>	3.3	<b>5.5</b>	V
$V_{OUT}$	NMOS configuration	Externally configured	<b>0.8</b>		<b>1.5</b>	V
$V_{FB}$	Feedback Voltage Accuracy			0.5		V
			-1.5		1.5	%
			<b>-2</b>		<b>2</b>	
PSRR	Power Supply Ripple Rejection	$F = 10\text{ kHz}$ , Load Current = $I_{MAX}$		-30		dB
$T_{ON}$	Turn On Time	Start up from shut-down		500		$\mu\text{sec}$
$C_{FB}$	Feedback Capacitor	C11 (Typ. App. Circuit)		12		pF
$C_{OUT}$	Output Capacitor C10, <sup>(3)</sup>	Capacitance for stability: $-40^\circ\text{C} \leq T_J \leq 125^\circ\text{C}$	<b>10</b>	<b>22</b>		$\mu\text{F}$
		ESR (Equivalent Series Resistance)		0.5		$\Omega$

(1) All voltages are with respect to the potential at the GND pin.

(2) Min and Max limits are guaranteed by design, test, or statistical analysis. Typical numbers are not guaranteed, but do represent the most likely norm.

(3) Absolute Maximum Ratings indicate limits beyond which damage to the component may occur. Operating Ratings are conditions under which operation of the device is guaranteed. Operating Ratings do not imply guaranteed performance limits. For guaranteed performance limits and associated test conditions, see the Electrical Characteristics tables.

## Buck Converters SW1, SW2

Unless otherwise noted, AVDD=AVIN=VIN1=VIN2 = 3.3V,  $C_{IN} = 10\ \mu\text{F}$ ,  $C_{OUT} = 22\ \mu\text{F}$ ,  $L_{OUT} = 0.5\ \mu\text{H}$ . Buck1 is configured to 1.8V. Buck2 is configured to 1.0V. Typical values and limits appearing in normal type apply for  $T_A = 25^\circ\text{C}$ . Limits appearing in **boldface type** apply over the entire junction temperature range for operation,  $-40^\circ\text{C}$  to  $+125^\circ\text{C}$ .<sup>(1) (2)</sup>

Symbol	Parameter	Conditions	Min	Typ	Max	Units
$V_{IN}$	VIN Range	AVDD=VIN1=VIN2	<b>3.0</b>	3.3	<b>5.5</b>	V
$V_{FB}$	Feedback Voltage Accuracy			0.5		%
			-1.0		+1.0	
			<b>-1.5</b>		<b>+1.5</b>	
$\Delta V_{OUT}$	DC Line Regulation	$3.0 < V_{IN} < 3.6$ $I_O = 1000\text{ mA}$		0.174		%/V
	DC Load Regulation	$100\text{ mA} < I_O < I_{MAX}$		0.75		%/A

(1) All voltages are with respect to the potential at the GND pin.

(2) Min and Max limits are guaranteed by design, test, or statistical analysis. Typical numbers are not guaranteed, but do represent the most likely norm.

## Buck Converters SW1, SW2 (continued)

Unless otherwise noted,  $AVDD=AVIN=VIN1=VIN2 = 3.3V$ ,  $C_{IN} = 10 \mu F$ ,  $C_{OUT} = 22 \mu F$ ,  $L_{OUT} = 0.5 \mu H$ . Buck1 is configured to 1.8V. Buck2 is configured to 1.0V. Typical values and limits appearing in normal type apply for  $T_A = 25^\circ C$ . Limits appearing in **boldface type** apply over the entire junction temperature range for operation,  $-40^\circ C$  to  $+125^\circ C$ .<sup>(1) (2)</sup>

Symbol	Parameter	Conditions	Min	Typ	Max	Units
$f_{OSC}$	Oscillator Frequency		1.8	2.0		MHz
$I_{PEAK}$	Peak Switching Current Limit			3.2		A
$R_{DSON} (P)$	Pin-Pin Resistance PFET			70	100	m $\Omega$
$R_{DSON} (N)$	Pin-Pin Resistance NFET			80	100	m $\Omega$
$T_{ON}$	Turn On Time	Start up from shut-down		500		$\mu$ sec
$C_{IN}$	Input Capacitor	Capacitance for stability	10			$\mu$ F
$C_O$	Output Capacitor	Capacitance for stability	10	22		$\mu$ F

## I/O Electrical Characteristics

Unless otherwise noted:  $AVDD=AVIN=VIN1=VIN2 = 3.3V$ . Typical values and limits appearing in normal type apply for  $T_J = 25^\circ C$ . Limits appearing in boldface type apply over the entire junction temperature range for operation,  $T_J = -40$  to  $+125^\circ C$ .<sup>(1) (2)</sup>

Symbol	Parameter	Min	Typ	Max	Units
$V_{IL}$	Input Low Level, ENSW1, ENSW2, ENLDO			<b>0.4</b>	V
$V_{IH}$	Input High Level, ENSW1, ENSW2, ENLDO	<b>0.8*<math>V_{IN}</math></b>			V
$I_{OH}$	nPOR		0.01	<b>2</b>	$\mu$ A
$V_{OL}$	nPOR		0.125	<b>0.25</b>	V
$T_{nPOR}$	nPOR Delay	60	200	475	msec

(1) All voltages are with respect to the potential at the GND pin.

(2) Min and Max limits are guaranteed by design, test, or statistical analysis. Typical numbers are not guaranteed, but do represent the most likely norm.

**Typical Performance Characteristics — LDO**

$T_A = 25^\circ\text{C}$  unless otherwise noted.

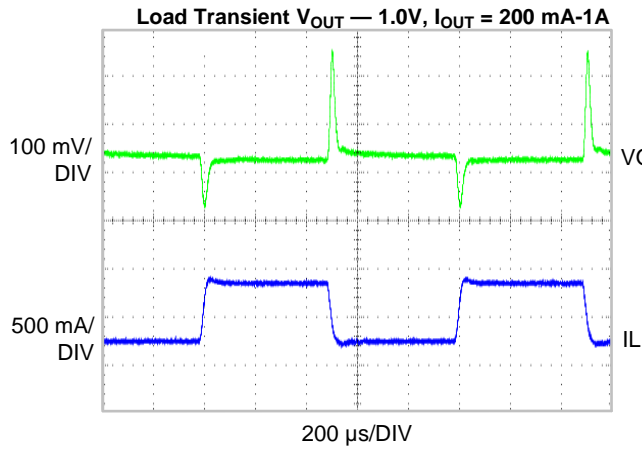

**Figure 2.**

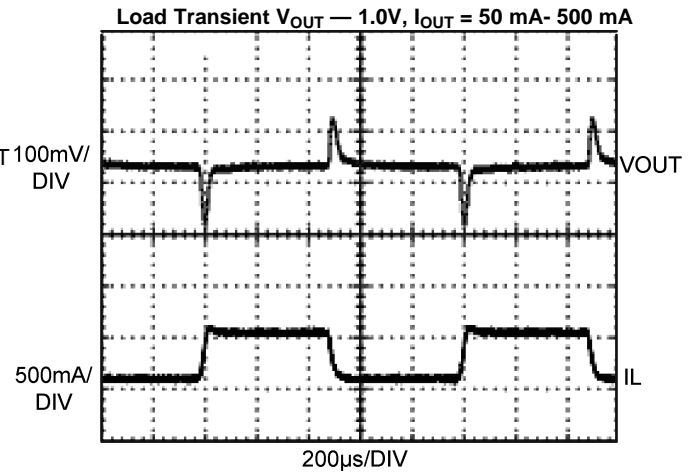

**Figure 3.**

### Typical Performance Characteristics — Buck

$T_A = 25^\circ\text{C}$  unless otherwise noted.

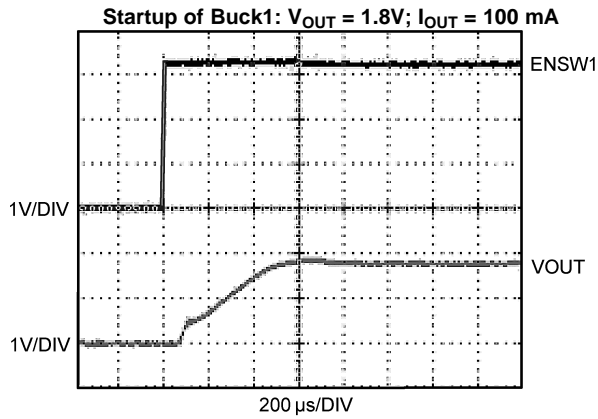

Figure 4.

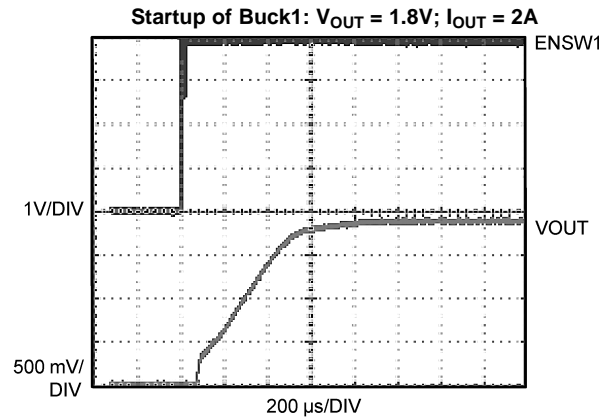

Figure 5.

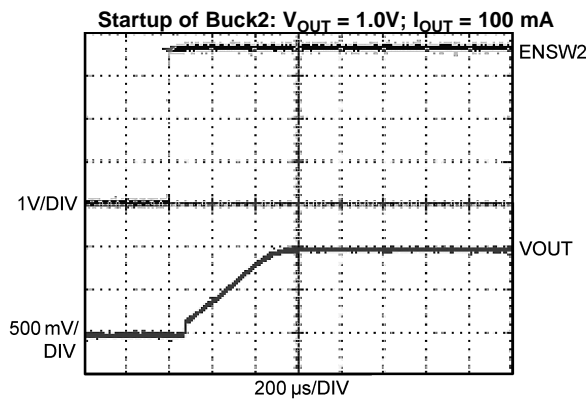

Figure 6.

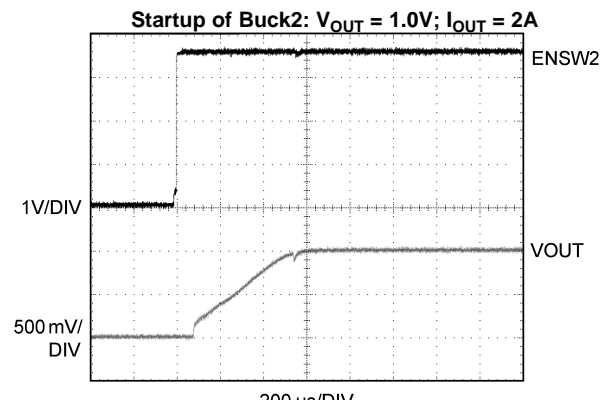

Figure 7.

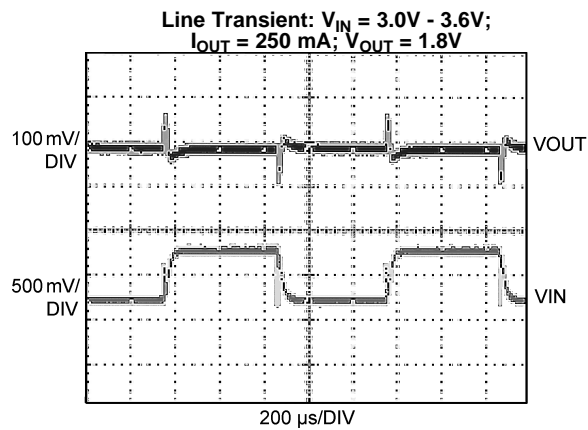

Figure 8.

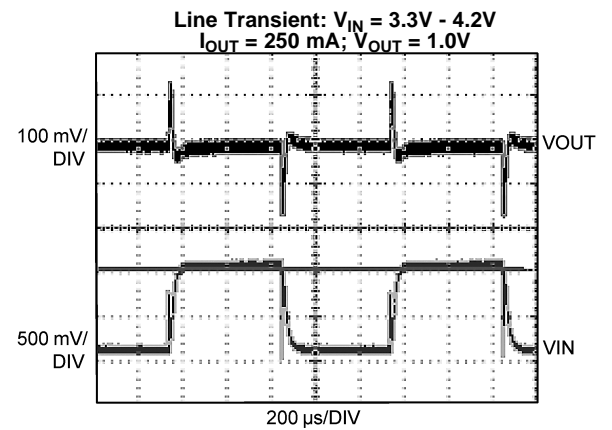

Figure 9.

Typical Performance Characteristics — Buck (continued)

T<sub>A</sub> = 25°C unless otherwise noted.

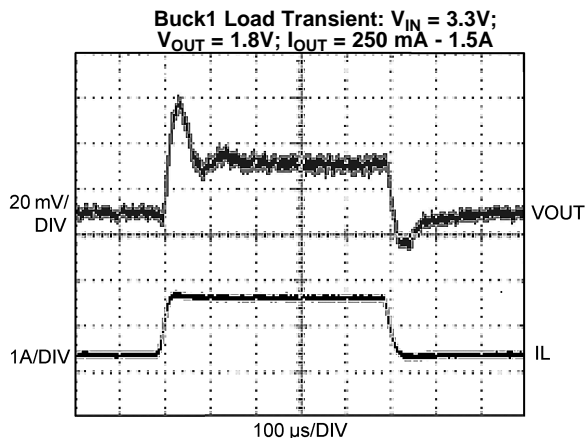

Figure 10.

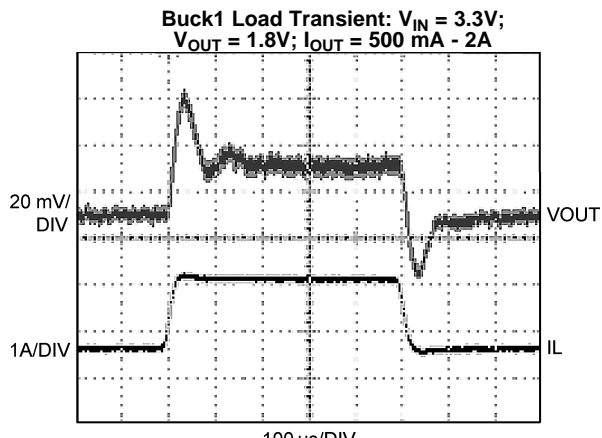

Figure 11.

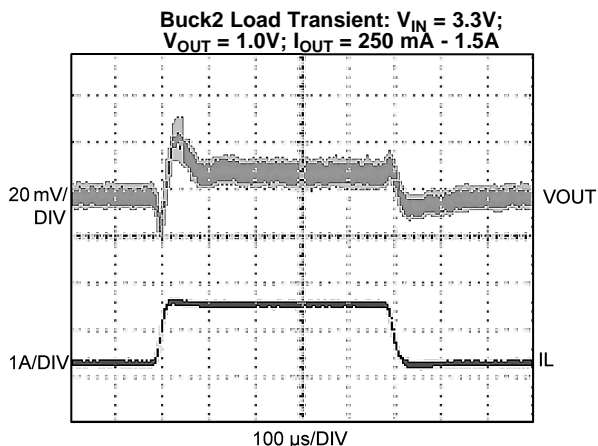

Figure 12.

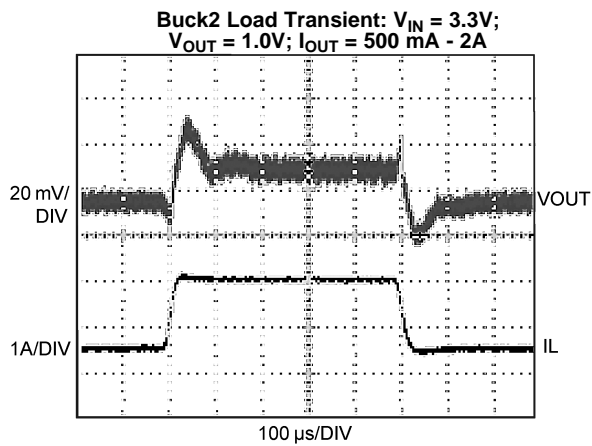

Figure 13.

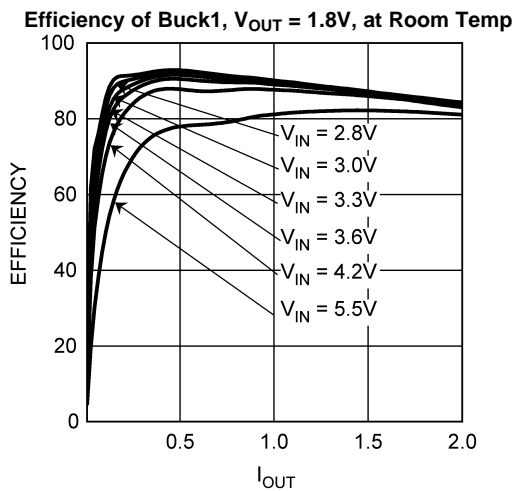

Figure 14.

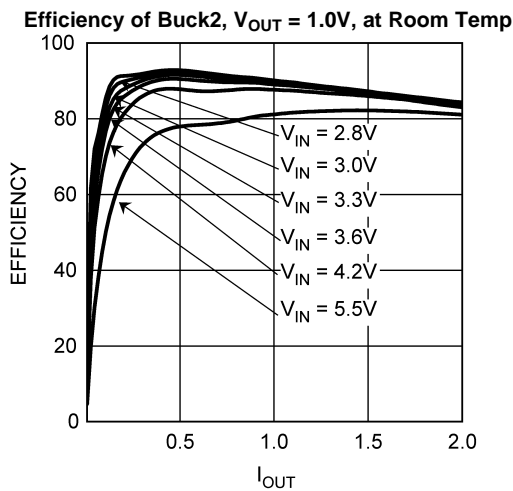

Figure 15.

**Typical Performance Characteristics — Buck (continued)** $T_A = 25^\circ\text{C}$  unless otherwise noted.

Figure 16.

## FLEXIBLE POWER SEQUENCING OF MULTIPLE POWER SUPPLIES

The two bucks and the LDO in the LM26484 can be individually controlled with ENSW1, ENSW2, and ENLDO, respectively. All the enable inputs need to be either grounded or tied to  $V_{IH}$ .

### Power-On Reset

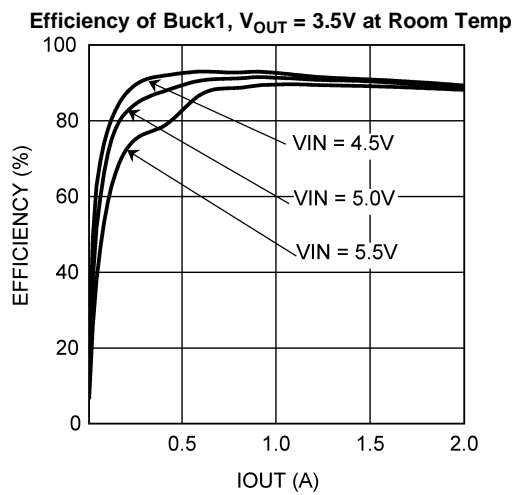
The LM26484 provides an active low reset output nPOR. Typical waveform is as shown in [Figure 17](#) below:

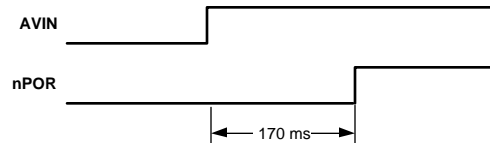

**Figure 17. Power-On Reset Waveform**

### LDO Functional Description

The LDO is a linear regulator which targets analog loads characterized by low noise requirements. The LDO is enabled through the ENLDO pin. The output voltage is determined by the configuration of the external feedback resistors, as seen in [Typical Application Circuit](#), R5 and R6.

### NO-LOAD STABILITY

The LDO will remain stable and in regulation with no external load. This is an important consideration in some circuits, for example CMOS RAM keep-alive applications.

**Table 1. LDO Configuration and Component Selection Guide**

Target $V_{OUT}(V)$	Ideal Resistor Values		Common R Values		Actual $V_{OUT}$ with Com R (V)	Feedback Capacitor
	R5 (K $\Omega$ )	R6 (K $\Omega$ )	R5 (K $\Omega$ )	R6 (K $\Omega$ )		C11 (pF)
0.8	120	200	120	200	0.8	15
0.9	160	200	162	200	0.905	15
1	200	200	200	200	1	15
1.1	240	200	240	200	1.1	15
1.2	280	200	280	200	1.2	12
1.3	320	200	324	200	1.31	12
1.4	360	200	357	200	1.393	10
1.5	400	200	402	200	1.505	10

### RESISTOR SELECTION FOR LDO

The output voltage of the LDO on the LM26484 is established by the feedback resistor divider R5 and R6 shown on the typical application circuit (page 1). The equation for determining  $V_{OUT}$  is:  $V_{OUT} = V_{FB} * (R5+R6)/R6$ , where  $V_{FB}$  is the voltage on the LDO\_FB pin.

The LDO control loop will force the voltage on  $V_{FB}$  to be 0.50V.

[Table 1](#) shows ideal resistor values to establish LDO voltages from 0.8V to 1.5V along with common resistor values to establish these voltages. Common resistors do not always produce the target value. The resulting output voltage using common resistors is also found in [Table 1](#). To keep the power consumed by the feedback network low it is recommended that R6 be established as about 200 k $\Omega$ . Lesser values of R6 are OK and can be used at the user's discretion.

## NFET SELECTION

There are a few major concerns when selecting an NFET for the LM26484 controller. The most important factor to consider is the maximum power rating. It is important for the NFET to have a maximum power rating larger than the application will need. The LM26484 has the ability to drive the gate voltage very close to VIN and down to approximately 1.5V. Selecting an NFET where the guaranteed operation of the  $V_{GS}$  is  $\geq 1.5V$  is important.

**Table 2. Recommended NFET**

Part Number	Vendor	$V_{GS}$	$P_{DISSIPATION}$
Si1450DH	Vishay	1.5V	2.78W

## EXTERNAL CAPACITORS

The LDO on the LM26484 requires external capacitors for regulator stability. These are specifically designed for portable applications requiring minimum board space and smallest components. These capacitors must be correctly selected for good performance. The tolerance and temperature coefficient must be considered when selecting the capacitor to ensure that the capacitance will remain close to ideal over the entire operating temperature range.

## FEEDBACK CAPACITOR

A Feedback capacitor is required for stability; recommended values can be seen in [Table 1](#). This capacitor must be located a distance of not more than 1 cm from the LDO\_FB pin and LDO\_OUT. Any good quality ceramic or film capacitor should be used.

## OUTPUT CAPACITOR

The LDO on the LM26484 is designed specifically to work with very small ceramic output capacitors. A 10.0  $\mu F$  ceramic capacitor, marked as C10 in the Typical Application Circuit on page 1, temperature types Z5U, Y5V or X7R with ESR between 5 m $\Omega$  to 500 m $\Omega$ , is suitable for proper operation.

It is also possible to use tantalum or film capacitors, but these are not as attractive for reasons of size and cost. The output capacitor must meet the requirement for the minimum value of capacitance and also have an ESR value that is within the range 50 m $\Omega$  to 500 m $\Omega$  for stability.

## CAPACITOR CHARACTERISTICS

The LDO is designed to work with ceramic capacitors on the output to take advantage of the benefits they offer. For capacitance values in the range of 0.47  $\mu F$  to 44  $\mu F$ , ceramic capacitors are the smallest, least expensive and have the lowest ESR values, thus making them best for eliminating high frequency noise. The ESR of a typical 10  $\mu F$  ceramic capacitor is in the range of 20 m $\Omega$  to 40 m $\Omega$ , which easily meets the ESR requirement for stability for the LDO.

For both input and output capacitors, careful interpretation of the capacitor specification is required to ensure correct device operation. The capacitor value can change greatly, depending on the operating conditions and capacitor type.

In particular, the output capacitor selection should take account of all the capacitor parameters, to ensure that the specification is met within the application. The capacitance can vary with DC bias conditions as well as temperature and frequency of operation. Capacitor values will also show some decrease over time due to aging. The capacitor parameters are also dependent on the particular case size, with smaller sizes giving poorer performance figures in general.

## Buck Regulator Functional Description

The LM26484 incorporates two high efficiency synchronous switching buck regulators which are 180° out of phase, SW1 and SW2 that deliver voltages from a single DC input voltage. Using a voltage mode architecture with synchronous rectification, both bucks have the ability to deliver up to 2A depending on the input voltage and output voltage (voltage head room), and the inductor chosen (maximum current capability).

There are three modes of operation depending on the current required - PWM, PFM, and shutdown. PWM mode handles current loads of approximately 70 mA or higher, delivering voltage precision with high efficiency. Lighter output current loads cause the device to automatically switch into PFM for reduced current consumption ( $I_q = 15 \mu\text{A}$  typ.) and a longer battery life. The Standby operating mode turns off the device, offering the lowest current consumption. Forced PWM is factory programmed. For Auto PFM-PWM please contact National Semiconductor Sales.

Both SW1 and SW2 can operate up to a 100% duty cycle (PMOS switch always on) for low drop out control of the output voltage. In this way the output voltage will be controlled down to the lowest possible input voltage.

Additional features include soft-start, under-voltage lockout, current overload protection, and thermal overload protection.

## PWM OPERATION

During PWM operation the converter operates as a voltage-mode controller with input voltage feed forward. This allows the converter to achieve excellent load and line regulation. The DC gain of the power stage is proportional to the input voltage. To eliminate this dependence, feed forward voltage inversely proportional to the input voltage is introduced.

## INTERNAL SYNCHRONOUS RECTIFICATION

While in PWM mode, the buck uses an internal NFET as a synchronous rectifier to reduce rectifier forward voltage drop and associated power loss. Synchronous rectification provides a significant improvement in efficiency whenever the output voltage is relatively low compared to the voltage drop across an ordinary rectifier diode.

## CURRENT LIMITING

A current limit feature allows the converter to protect the LM26484 and any external components during overload conditions. An internal comparator senses the voltage across an internal sense resistor and will turn on the NFET when the output current is sensed at 2.5A (min.) with 0.5  $\mu\text{H}$  inductors. If the output is shorted to ground the device enters a timed current limit mode where the NFET is turned on for a longer duration until the inductor current falls below a low threshold, ensuring inductor current has more time to decay, thereby preventing runaway.

## PFM OPERATION

At very light loads, the converter enters PFM mode and operates with reduced switching frequency and supply current to maintain high efficiency. For the PFM mode to be enabled, please contact National Semiconductor Sales.

The part will automatically transition into PFM mode when either of two conditions occurs for a duration of 32 or more clock cycles:

- A. The inductor current becomes discontinuous

or

- B. The peak PMOS switch current drops below the  $I_{\text{MODE}}$  level

$$\left( \text{Typically } I_{\text{MODE}} < 66 \text{ mA} + \frac{V_{\text{IN}}}{100\Omega} \right) \quad (1)$$

During PFM operation, the converter positions the output voltage slightly higher than the nominal output voltage during PWM operation, allowing additional headroom for voltage drop during a load transient from light to heavy load. The PFM comparators sense the output voltage via the feedback pin and control the switching of the output FETs such that the output voltage ramps between 0.8% and 1.6% (typ.) above the nominal PWM output voltage. If the output voltage is below the 'high' PFM comparator threshold, the PMOS power switch is turned on. It remains on until the output voltage exceeds the 'high' PFM threshold or the peak current exceeds the  $I_{\text{PFM}}$  level set for PFM mode. The typical peak current in PFM mode is:

$$I_{\text{PFM}} = 66 \text{ mA} + \frac{V_{\text{IN}}}{80\Omega} \quad (2)$$

Once the PMOS power switch is turned off, the NMOS power switch is turned on until the inductor current ramps to zero. When the NMOS zero-current condition is detected, the NMOS power switch is turned off. If the output voltage is below the 'high' PFM comparator threshold (see Figure 18), the PMOS switch is again turned on and the cycle is repeated until the output reaches the desired level. Once the output reaches the 'high' PFM threshold, the NMOS switch is turned on briefly to ramp the inductor current to zero and then both output switches are turned off and the part enters an extremely low power mode. Quiescent supply current during this 'sleep' mode is less than 30  $\mu\text{A}$ , which allows the part to achieve high efficiencies under extremely light load conditions. When the output drops below the 'low' PFM threshold, the cycle repeats to restore the output voltage to  $\sim 1.6\%$  above the nominal PWM output voltage.

If the load current should increase during PFM mode (see Figure 18) causing the output voltage to fall below the 'low2' PFM threshold, the part will automatically transition into fixed-frequency PWM mode.

During shutdown the PFET switch, reference, control and bias circuitry of the converters are turned off. The NFET switch will be on in shutdown to discharge the output. When the converter is enabled, soft start is activated. It is recommended to disable the converter during the system power up and under voltage conditions when the supply is less than 3.0V.

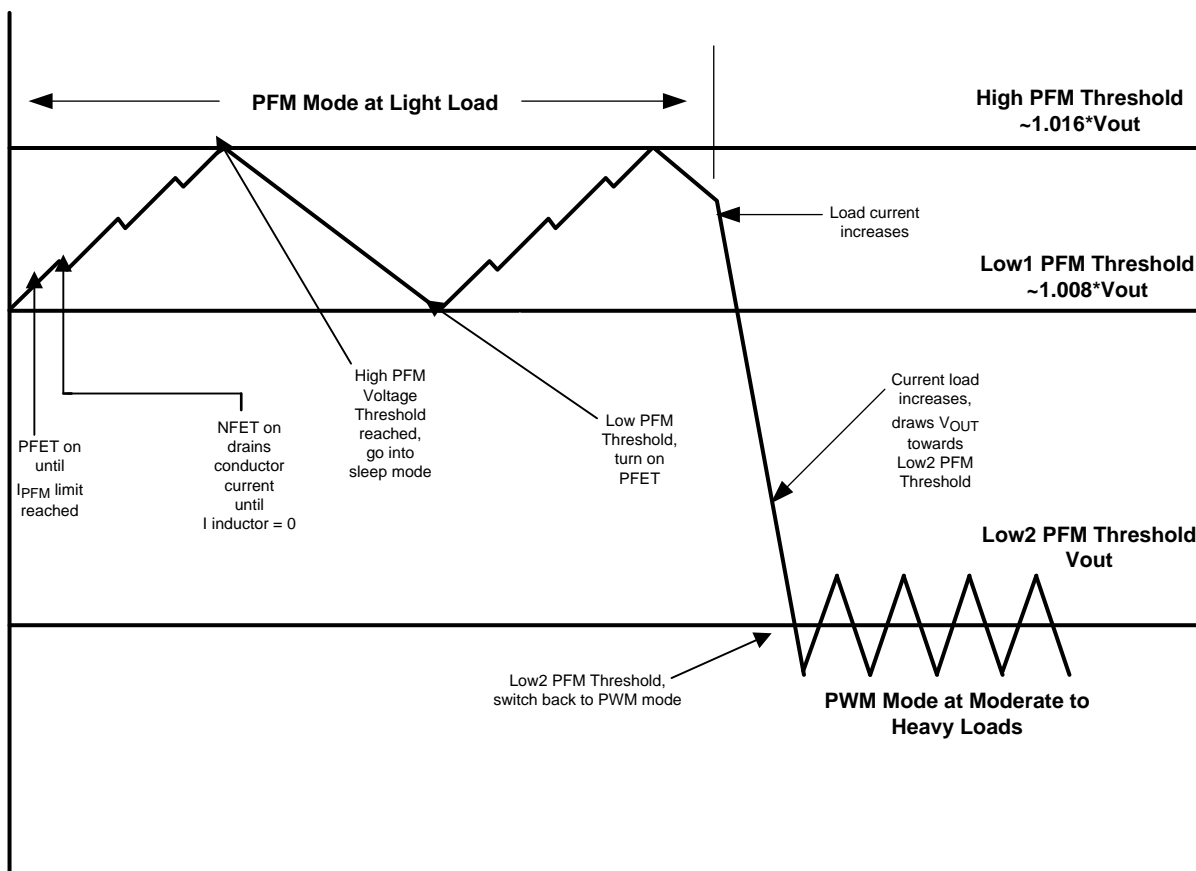

-18

Figure 18. PFM vs PWM

## SOFT START

The soft-start feature allows the power converter to gradually reach the initial steady state operating point, thus reducing start-up stresses and surges. The two LM26484 buck converters have a soft-start circuit that limits in-rush current during start-up or the one which ramps up output voltage linearly over about 500  $\mu\text{s}$ . During start-up the switch current limit is ramped up (100  $\mu\text{s}$ , typ.), depending on the kind of soft-start. Soft start is activated only if EN goes from logic low to logic high after  $V_{IN}$  reaches 2.8V.

## LOW DROPOUT OPERATION

The LM26484 can operate at 100% duty cycle (no switching; PMOS switch completely on) for low dropout support of the output voltage. In this way the output voltage will be controlled down to the lowest possible input voltage. When the device operates near 100% duty cycle, output voltage ripple is approximately 25 mV. The minimum input voltage needed to support the output voltage is

$$V_{IN, MIN} = I_{LOAD} * (R_{DSON, PFET} + R_{INDUCTOR}) + V_{OUT} \quad (3)$$

$I_{LOAD}$	Load current
$R_{DSON, PFET}$	Drain to source resistance of PFET switch in the triode region
$R_{INDUCTOR}$	Inductor resistance

## Component Selection

### SW1, SW2 OPERATION

**Table 3. Buck1/2 Configuration and Component Selection Guide**

Target $V_{OUT}$ (V)	Ideal Resistor Values		Common R Values		Actual $V_{OUT}$ with Com/R (V)	Actual $V_{OUT}$ Delta from Target (V)	Feedback Capacitors	
	R1/3 (K $\Omega$ )	R2/4 (K $\Omega$ )	R1/3 (K $\Omega$ )	R2/4 (K $\Omega$ )			C3/6 (pF)	C4/8 (pF)
0.8	120	200	121	200	0.803	0.002	15	none
0.9	160	200	162	200	0.905	0.005	15	none
1	200	200	200	200	1	0	15	none
1.1	240	200	240	200	1.1	0	15	none
1.2	280	200	280	200	1.2	0	12	none
1.3	320	200	324	200	1.31	0.01	12	none
1.4	360	200	357	200	1.393	-0.008	10	none
1.5	400	200	402	200	1.505	0.005	10	none
1.6	440	200	442	200	1.605	0.005	8.2	none
1.7	427	178	432	178	1.713	0.013	8.2	none
1.8	463	178	464	178	1.803	0.003	8.2	none
1.9	498	178	499	178	1.902	0.002	8.2	none
2	450	150	453	150	2.01	0.01	8.2	none
2.1	480	150	475	150	2.083	-0.017	8.2	none
2.2	422	124	422	124	2.202	0.002	8.2	none
2.3	446	124	442	124	2.282	-0.018	8.2	none
2.4	471	124	475	124	2.415	0.015	8.2	none
2.5	400	100	402	100	2.51	0.01	8.2	none
2.6	420	100	422	100	2.61	0.01	8.2	none
2.7	440	100	442	100	2.71	0.01	8.2	33
2.8	460	100	464	100	2.82	0.02	8.2	33
2.9	480	100	475	100	2.875	-0.025	8.2	33
3	500	100	499	100	2.995	-0.005	6.8	33
3.1	520	100	523	100	3.115	0.015	6.8	33
3.2	540	100	536	100	3.18	-0.02	6.8	33
3.3	560	100	562	100	3.31	0.01	6.8	33
3.4	580	100	576	100	3.38	-0.02	6.8	33
3.5	600	100	604	100	3.52	0.02	6.8	33

The Buck control loop will force the voltage on  $V_{FB}$  to be 0.50V.

Table 3 shows ideal resistor values to establish buck voltages from 0.8V to 3.5V along with common resistor values to establish these voltages. Common resistors do not always produce the target value, error is given in the delta column.

In addition to the resistor feedback, feedback capacitors are also required. (Table 3 — C3/4/6/8) When choosing the output voltage for the two bucks, please take into account the fact that, the factory has optimized the accuracy of Buck1 at the top end of the  $V_{OUT}$  range and Buck2 for the bottom end of the  $V_{OUT}$  range.

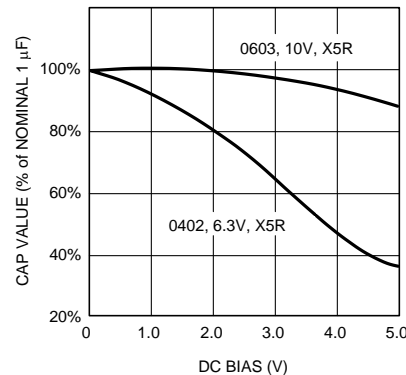

**Figure 19. Typical Variation in Capacitance vs. DC Bias**

As shown in Table 3, increasing the DC Bias condition can result in a capacitance value that falls below the minimum value given in the recommended capacitor specifications table. Note that the graph shows the capacitance out of spec for the 0402 case size capacitor at higher bias voltages. It is therefore recommended that the capacitor manufacturers' specifications for the nominal value capacitor are consulted for all conditions, as some capacitor sizes (e.g. 0402) may not be suitable in the actual application.

The ceramic capacitor's capacitance can vary with temperature. The capacitor type X7R, which operates over a temperature range of  $-55^{\circ}\text{C}$  to  $+125^{\circ}\text{C}$ , will only vary the capacitance to within  $\pm 15\%$ . The capacitor type X5R has a similar tolerance over a reduced temperature range of  $-55^{\circ}\text{C}$  to  $+85^{\circ}\text{C}$ . Many large value ceramic capacitors, larger than  $1\ \mu\text{F}$  are manufactured with Z5U or Y5V temperature characteristics. Their capacitance can drop by more than 50% as the temperature varies from  $25^{\circ}\text{C}$  to  $85^{\circ}\text{C}$ . Therefore X7R is recommended over Z5U and Y5V in applications where the ambient temperature will change significantly above or below  $25^{\circ}\text{C}$ .

Tantalum capacitors are less desirable than ceramic for use as output capacitors because they are more expensive when comparing equivalent capacitance and voltage ratings in the  $0.47\ \mu\text{F}$  to  $44\ \mu\text{F}$  range. Another important consideration is that tantalum capacitors have higher ESR values than equivalent size ceramics. This means that while it may be possible to find a tantalum capacitor with an ESR value within the stable range, it would have to be larger in capacitance (which means bigger and more costly) than a ceramic capacitor with the same ESR value. It should also be noted that the ESR of a typical tantalum will increase about 2:1 as the temperature goes from  $25^{\circ}\text{C}$  down to  $-40^{\circ}\text{C}$ , so some guard band must be allowed.

## OUTPUT INDUCTORS & CAPACITORS FOR SW1 AND SW2

There are several design considerations related to the selection of output inductors and capacitors:

- Load transient response;
- Stability;
- Efficiency;
- Output ripple voltage; and
- Over-current ruggedness.

The LM26484 has been optimized for use with nominal values  $0.5\ \mu\text{H}$  and  $22\ \mu\text{F}$ . If other values are needed for the design, please contact National Semiconductor sales with any concerns.

## INDUCTOR SELECTION FOR SW1 AND SW2

A nominal inductor value of 0.5  $\mu\text{H}$  is recommended. It is important to guarantee the inductor core does not saturate during any foreseeable operational situation.

Care should be taken when reviewing the different saturation current ratings that are specified by different manufacturers. Saturation current ratings are typically specified at 25°C, so ratings at maximum ambient temperature of the application should be requested from the manufacturer.

There are two methods to choose the inductor saturation current rating:

### Recommended method:

The best way to guarantee the inductor does not saturate is to choose an inductor that has saturation current rating greater than the maximum LM26484 current limit of 3.0A. In this case the device will prevent inductor saturation.

### Alternate method:

If the recommended approach cannot be used, care must be taken to guarantee that the saturation current is greater than the peak inductor current:

$$I_{\text{SAT}} > I_{\text{LPEAK}}$$

$$I_{\text{LPEAK}} = I_{\text{OUTMAX}} + \frac{I_{\text{RIPPLE}}}{2}$$

$$I_{\text{RIPPLE}} = \frac{D \times (V_{\text{IN}} - V_{\text{OUT}})}{L \times F}$$

$$D = \frac{V_{\text{OUT}}}{V_{\text{IN}} \times \text{EFF}}$$

where

- $I_{\text{SAT}}$ : Inductor saturation current at operating temperature
- $I_{\text{LPEAK}}$ : Peak inductor current during worst case conditions
- $I_{\text{OUTMAX}}$ : Maximum average inductor current
- $I_{\text{RIPPLE}}$ : Peak-to-Peak inductor current
- $V_{\text{OUT}}$ : Output voltage
- $V_{\text{IN}}$ : Input voltage
- L: Inductor value in Henries at  $I_{\text{OUTMAX}}$
- F: Switching frequency, Hertz
- D: Estimated duty factor
- EFF: Estimated power supply efficiency
- 

(4)

$I_{\text{SAT}}$  may not be exceeded during any operation, including transients, startup, high temperature, worst case conditions, etc.

Inductor	Value	Unit	Description	Notes
L1 and L2	0.5	$\mu\text{H}$	SW1 and SW2 inductor	D.C.R. 50 m $\Omega$

## SUGGESTED INDUCTORS AND THEIR SUPPLIERS

Output Voltage Range	Vendor	Part Number	Value	DCR (max)
$V_{\text{OUT}} \geq 2.0\text{V}$	Coilcraft	LPS4012–222ML	2.2 $\mu\text{H}$	100 m $\Omega$
$V_{\text{OUT}} < 2.0\text{V}$	Coilcraft	LPS4414–501ML	0.5 $\mu\text{H}$	50 m $\Omega$

## OUTPUT CAPACITOR SELECTION FOR SW1 AND SW2

A ceramic output capacitor of 10  $\mu\text{F}$ , 6.3V is recommended with an ESR of less than 500 m $\Omega$ .

Output ripple can be estimated from the vector sum of the reactive (Capacitor) voltage component and the real (ESR) voltage component of the output capacitor.

$$V_{\text{COUT}} = \frac{I_{\text{RIPPLE}}}{8 \times F \times C_{\text{OUT}}}$$

$$V_{\text{ROUT}} = I_{\text{RIPPLE}} \times \text{ESR}_{\text{COUT}}$$

$$V_{\text{PPOUT}} = \sqrt{V_{\text{COUT}}^2 + V_{\text{ROUT}}^2}$$

where

- $V_{\text{COUT}}$ : Estimated reactive output ripple
- $V_{\text{ROUT}}$ : Estimated real output ripple
- $V_{\text{PPOUT}}$ : Estimated peak-to-peak output ripple

(5)

The output capacitor needs to be mounted as close as possible to the output pin of the device.

The output filter capacitor smooths out current flow from the inductor to the load, helps maintain a steady output voltage during transient load changes and reduces output voltage ripple. These capacitors must be selected with sufficient capacitance and sufficiently low ESR to perform these functions.

Note that the output voltage ripple is dependent on the inductor current ripple and the equivalent series resistance of the output capacitor ( $\text{ESR}_{\text{COUT}}$ ).  $\text{ESR}_{\text{COUT}}$  is frequency dependent as well as temperature dependent. The  $R_{\text{ESR}}$  should be calculated with the applicable switching frequency and ambient temperature.

### INPUT CAPACITOR SELECTION FOR SW1 AND SW2

It is required to use a ceramic input capacitor of at least 10  $\mu\text{F}$  and 6.3V with an ESR of less than 500 m $\Omega$ .

The input power source supplies average current continuously. During the PFET switch on-time, however, the demanded di/dt is higher than can be typically supplied by the input power source. This delta is supplied by the input capacitor.

A simplified “worst case” assumption is that all of the PFET current is supplied by the input capacitor. This will result in conservative estimates of input ripple voltage and capacitor RMS current. Input ripple voltage is estimated as follows:

$$V_{\text{PPIN}} = \frac{I_{\text{OUT}} \times D}{C_{\text{IN}} \times F} + I_{\text{OUT}} \times \text{ESR}_{\text{CIN}}$$

where

- $V_{\text{PPIN}}$ : Estimated peak-to-peak input ripple voltage
- $I_{\text{OUT}}$ : Output current, Amps
- $C_{\text{IN}}$ : Input capacitor value, Farads
- $\text{ESR}_{\text{CIN}}$ : Input capacitor ESR, Ohms

(6)

This capacitor is exposed to significant RMS current, so it is important to select a capacitor with an adequate RMS current rating. Capacitor RMS current estimated as follows:

$$I_{\text{RMSCIN}} = \sqrt{D \times \left( I_{\text{OUT}}^2 + \frac{I_{\text{RIPPLE}}^2}{12} \right)}$$

where

- $I_{\text{RMSCIN}}$ : Estimated input capacitor RMS current

(7)

Model	Type	Vendor	Voltage Rating	Case Size Inch (mm)
<b>10 <math>\mu\text{F}</math> for CIN or COUT; C9, C2, C1, C5, C7, C10</b>				
GRM21BR60J106K	Ceramic, X7R	Murata	6.3V	0805, (2012)
JMK212BJ106K	Ceramic, X5R	Taiyo-Yuden	6.3V	0805, (2012)
LMK212C106KG-T	Ceramic, X7R	Taiyo-Yuden	10V	0805, (2012)
C1608X5R0J106K	Ceramic, X5R	TDK	6.3V	0603, (1608)

Model	Type	Vendor	Voltage Rating	Case Size Inch (mm)
<b>22 <math>\mu</math>F for COUT; C10, C2, C7</b>				
GRM31CR70J226KE23L	Ceramic, X7R	Murata	6.3V	1206, (3216)
JMK316B7226ML-T	Ceramic, X7R	Taiyo-Yuden	6.3V	1206, (3216)

Capacitor	Min Value	Unit	Description	Recommended Type
C10, <a href="#">Table 3</a>	10.0	$\mu$ F	LDO1 output capacitor	Ceramic, 6.3V, X5R
C2, <a href="#">Table 3</a>	10.0	$\mu$ F	SW1 output capacitor	Ceramic, 6.3V, X5R
C7, <a href="#">Table 3</a>	10.0	$\mu$ F	SW2 output capacitor	Ceramic, 6.3V, X5R

## PACKAGING INFORMATION

Orderable Device	Status (1)	Package Type	Package Drawing	Pins	Package Qty	Eco Plan (2)	Lead/Ball Finish	MSL Peak Temp (3)	Op Temp (°C)	Top-Side Markings (4)	Samples
LM26484SQ/NOPB	ACTIVE	WQFN	NHZ	24	1000	Green (RoHS & no Sb/Br)	CU SN	Level-1-260C-UNLIM		26484SQ	<a href="#">Samples</a>
LM26484SQE/NOPB	ACTIVE	WQFN	NHZ	24	250	Green (RoHS & no Sb/Br)	CU SN	Level-1-260C-UNLIM		26484SQ	<a href="#">Samples</a>
LM26484SQX/NOPB	ACTIVE	WQFN	NHZ	24	4500	Green (RoHS & no Sb/Br)	CU SN	Level-1-260C-UNLIM		26484SQ	<a href="#">Samples</a>

(1) The marketing status values are defined as follows:

**ACTIVE:** Product device recommended for new designs.

**LIFEBUY:** TI has announced that the device will be discontinued, and a lifetime-buy period is in effect.

**NRND:** Not recommended for new designs. Device is in production to support existing customers, but TI does not recommend using this part in a new design.

**PREVIEW:** Device has been announced but is not in production. Samples may or may not be available.

**OBSOLETE:** TI has discontinued the production of the device.

(2) Eco Plan - The planned eco-friendly classification: Pb-Free (RoHS), Pb-Free (RoHS Exempt), or Green (RoHS & no Sb/Br) - please check <http://www.ti.com/productcontent> for the latest availability information and additional product content details.

**TBD:** The Pb-Free/Green conversion plan has not been defined.

**Pb-Free (RoHS):** TI's terms "Lead-Free" or "Pb-Free" mean semiconductor products that are compatible with the current RoHS requirements for all 6 substances, including the requirement that lead not exceed 0.1% by weight in homogeneous materials. Where designed to be soldered at high temperatures, TI Pb-Free products are suitable for use in specified lead-free processes.

**Pb-Free (RoHS Exempt):** This component has a RoHS exemption for either 1) lead-based flip-chip solder bumps used between the die and package, or 2) lead-based die adhesive used between the die and leadframe. The component is otherwise considered Pb-Free (RoHS compatible) as defined above.

**Green (RoHS & no Sb/Br):** TI defines "Green" to mean Pb-Free (RoHS compatible), and free of Bromine (Br) and Antimony (Sb) based flame retardants (Br or Sb do not exceed 0.1% by weight in homogeneous material)

(3) MSL, Peak Temp. -- The Moisture Sensitivity Level rating according to the JEDEC industry standard classifications, and peak solder temperature.

(4) Only one of markings shown within the brackets will appear on the physical device.

**Important Information and Disclaimer:** The information provided on this page represents TI's knowledge and belief as of the date that it is provided. TI bases its knowledge and belief on information provided by third parties, and makes no representation or warranty as to the accuracy of such information. Efforts are underway to better integrate information from third parties. TI has taken and continues to take reasonable steps to provide representative and accurate information but may not have conducted destructive testing or chemical analysis on incoming materials and chemicals. TI and TI suppliers consider certain information to be proprietary, and thus CAS numbers and other limited information may not be available for release.

In no event shall TI's liability arising out of such information exceed the total purchase price of the TI part(s) at issue in this document sold by TI to Customer on an annual basis.

**TAPE AND REEL INFORMATION**

**QUADRANT ASSIGNMENTS FOR PIN 1 ORIENTATION IN TAPE**

\*All dimensions are nominal

Device	Package Type	Package Drawing	Pins	SPQ	Reel Diameter (mm)	Reel Width W1 (mm)	A0 (mm)	B0 (mm)	K0 (mm)	P1 (mm)	W (mm)	Pin1 Quadrant
LM26484SQ/NOPB	WQFN	NHZ	24	1000	178.0	12.4	4.3	5.3	1.3	8.0	12.0	Q1
LM26484SQE/NOPB	WQFN	NHZ	24	250	178.0	12.4	4.3	5.3	1.3	8.0	12.0	Q1
LM26484SQX/NOPB	WQFN	NHZ	24	4500	330.0	12.4	4.3	5.3	1.3	8.0	12.0	Q1

**TAPE AND REEL BOX DIMENSIONS**

\*All dimensions are nominal

Device	Package Type	Package Drawing	Pins	SPQ	Length (mm)	Width (mm)	Height (mm)
LM26484SQ/NOPB	WQFN	NHZ	24	1000	203.0	190.0	41.0
LM26484SQE/NOPB	WQFN	NHZ	24	250	203.0	190.0	41.0
LM26484SQX/NOPB	WQFN	NHZ	24	4500	349.0	337.0	45.0



## IMPORTANT NOTICE

Texas Instruments Incorporated and its subsidiaries (TI) reserve the right to make corrections, enhancements, improvements and other changes to its semiconductor products and services per JESD46, latest issue, and to discontinue any product or service per JESD48, latest issue. Buyers should obtain the latest relevant information before placing orders and should verify that such information is current and complete. All semiconductor products (also referred to herein as "components") are sold subject to TI's terms and conditions of sale supplied at the time of order acknowledgment.

TI warrants performance of its components to the specifications applicable at the time of sale, in accordance with the warranty in TI's terms and conditions of sale of semiconductor products. Testing and other quality control techniques are used to the extent TI deems necessary to support this warranty. Except where mandated by applicable law, testing of all parameters of each component is not necessarily performed.

TI assumes no liability for applications assistance or the design of Buyers' products. Buyers are responsible for their products and applications using TI components. To minimize the risks associated with Buyers' products and applications, Buyers should provide adequate design and operating safeguards.

TI does not warrant or represent that any license, either express or implied, is granted under any patent right, copyright, mask work right, or other intellectual property right relating to any combination, machine, or process in which TI components or services are used. Information published by TI regarding third-party products or services does not constitute a license to use such products or services or a warranty or endorsement thereof. Use of such information may require a license from a third party under the patents or other intellectual property of the third party, or a license from TI under the patents or other intellectual property of TI.

Reproduction of significant portions of TI information in TI data books or data sheets is permissible only if reproduction is without alteration and is accompanied by all associated warranties, conditions, limitations, and notices. TI is not responsible or liable for such altered documentation. Information of third parties may be subject to additional restrictions.

Resale of TI components or services with statements different from or beyond the parameters stated by TI for that component or service voids all express and any implied warranties for the associated TI component or service and is an unfair and deceptive business practice. TI is not responsible or liable for any such statements.

Buyer acknowledges and agrees that it is solely responsible for compliance with all legal, regulatory and safety-related requirements concerning its products, and any use of TI components in its applications, notwithstanding any applications-related information or support that may be provided by TI. Buyer represents and agrees that it has all the necessary expertise to create and implement safeguards which anticipate dangerous consequences of failures, monitor failures and their consequences, lessen the likelihood of failures that might cause harm and take appropriate remedial actions. Buyer will fully indemnify TI and its representatives against any damages arising out of the use of any TI components in safety-critical applications.

In some cases, TI components may be promoted specifically to facilitate safety-related applications. With such components, TI's goal is to help enable customers to design and create their own end-product solutions that meet applicable functional safety standards and requirements. Nonetheless, such components are subject to these terms.

No TI components are authorized for use in FDA Class III (or similar life-critical medical equipment) unless authorized officers of the parties have executed a special agreement specifically governing such use.

Only those TI components which TI has specifically designated as military grade or "enhanced plastic" are designed and intended for use in military/aerospace applications or environments. Buyer acknowledges and agrees that any military or aerospace use of TI components which have **not** been so designated is solely at the Buyer's risk, and that Buyer is solely responsible for compliance with all legal and regulatory requirements in connection with such use.

TI has specifically designated certain components as meeting ISO/TS16949 requirements, mainly for automotive use. In any case of use of non-designated products, TI will not be responsible for any failure to meet ISO/TS16949.

### Products

Audio	<a href="http://www.ti.com/audio">www.ti.com/audio</a>
Amplifiers	<a href="http://amplifier.ti.com">amplifier.ti.com</a>
Data Converters	<a href="http://dataconverter.ti.com">dataconverter.ti.com</a>
DLP® Products	<a href="http://www.dlp.com">www.dlp.com</a>
DSP	<a href="http://dsp.ti.com">dsp.ti.com</a>
Clocks and Timers	<a href="http://www.ti.com/clocks">www.ti.com/clocks</a>
Interface	<a href="http://interface.ti.com">interface.ti.com</a>
Logic	<a href="http://logic.ti.com">logic.ti.com</a>
Power Mgmt	<a href="http://power.ti.com">power.ti.com</a>
Microcontrollers	<a href="http://microcontroller.ti.com">microcontroller.ti.com</a>
RFID	<a href="http://www.ti-rfid.com">www.ti-rfid.com</a>
OMAP Applications Processors	<a href="http://www.ti.com/omap">www.ti.com/omap</a>
Wireless Connectivity	<a href="http://www.ti.com/wirelessconnectivity">www.ti.com/wirelessconnectivity</a>

### Applications

Automotive and Transportation	<a href="http://www.ti.com/automotive">www.ti.com/automotive</a>
Communications and Telecom	<a href="http://www.ti.com/communications">www.ti.com/communications</a>
Computers and Peripherals	<a href="http://www.ti.com/computers">www.ti.com/computers</a>
Consumer Electronics	<a href="http://www.ti.com/consumer-apps">www.ti.com/consumer-apps</a>
Energy and Lighting	<a href="http://www.ti.com/energy">www.ti.com/energy</a>
Industrial	<a href="http://www.ti.com/industrial">www.ti.com/industrial</a>
Medical	<a href="http://www.ti.com/medical">www.ti.com/medical</a>
Security	<a href="http://www.ti.com/security">www.ti.com/security</a>
Space, Avionics and Defense	<a href="http://www.ti.com/space-avionics-defense">www.ti.com/space-avionics-defense</a>
Video and Imaging	<a href="http://www.ti.com/video">www.ti.com/video</a>

### TI E2E Community

[e2e.ti.com](http://e2e.ti.com)