

Low power dual operational amplifiers

NE/SA/SE532/ LM158/258/358/A/2904

DESCRIPTION

The 532/358/LM2904 consists of two independent, high gain, internally frequency-compensated operational amplifiers internally frequency-compensated operational amplifiers designed specifically to operate from a single power supply over a wide range of voltages. Operation from dual power supplies is also possible, and the low power supply current drain is independent of the magnitude of the power supply voltage.

UNIQUE FEATURES

In the linear mode the input common-mode voltage range includes ground and the output voltage can also swing to includes ground and the output voltage can also swing to ground, even though operated from only a single power supply voltage. The unity gain cross frequency is temperature-compensated. The input bias current is also temperature-compensated.

FEATURES

- Internally frequency-compensated for unity gain
- Large DC voltage gain—100dB
- Wide bandwidth (unity gain)—1MHz (temperature-compensated)

PIN CONFIGURATIONS

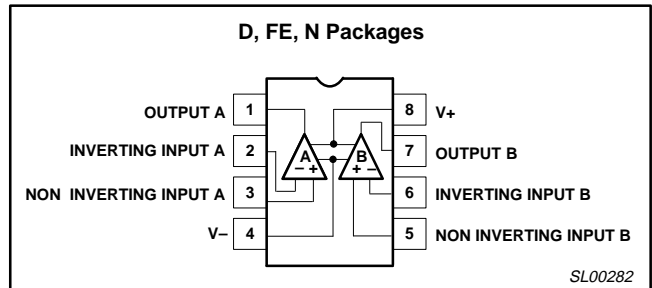

Figure 1. Pin Configuration

- Wide power supply range single supply— $3V_{DC}$ to $30V_{DC}$ or dual supplies— $\pm 1.5V_{DC}$ to $\pm 15V_{DC}$
- Very low supply current drain ($400\mu A$)—essentially independent of supply voltage ($1mW/op\ amp$ at $+5V_{DC}$)
- Low input biasing current— $45nA_{DC}$ temperature-compensated
- Low input offset voltage— $2mV_{DC}$ and offset current— $5nA_{DC}$
- Differential input voltage range equal to the power supply voltage
- Large output voltage— $0V_{DC}$ to $V+ 1.5V_{DC}$ swing

EQUIVALENT CIRCUIT

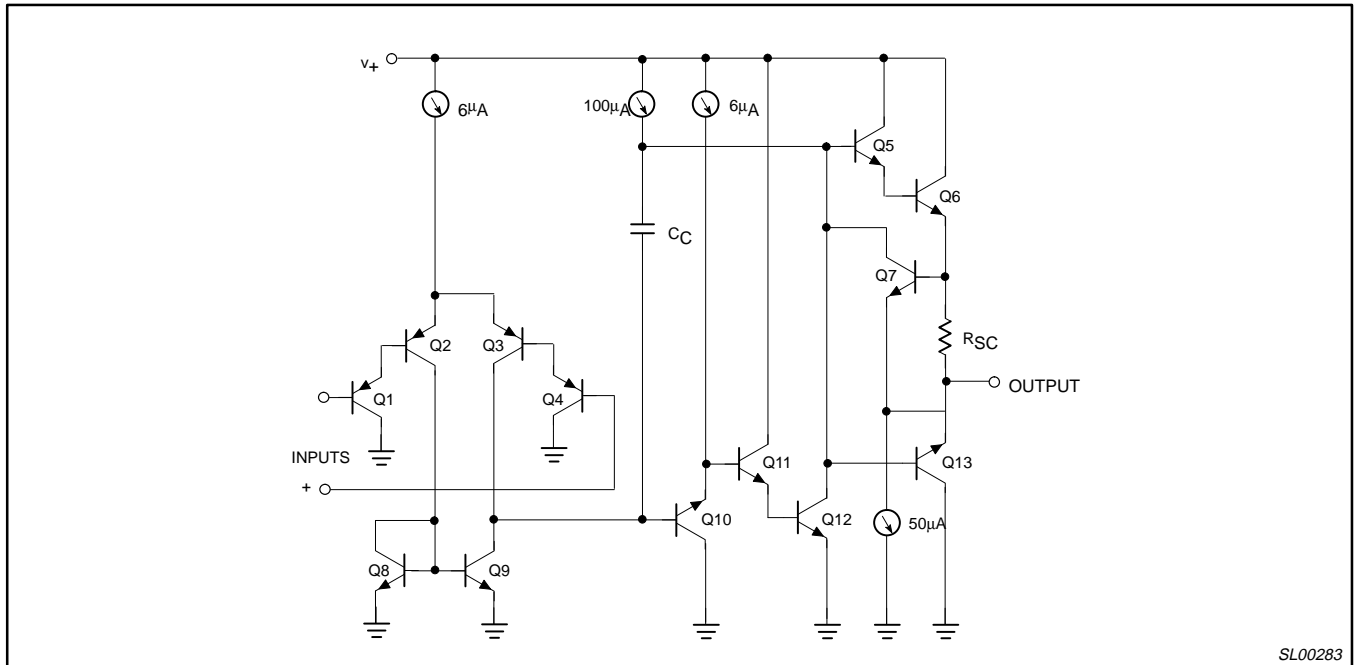

Figure 2. Equivalent Circuit

Low power dual operational amplifiers

NE/SA/SE532/
LM158/258/358/A/2904

ORDERING INFORMATION

DESCRIPTION	TEMPERATURE RANGE	ORDER CODE	DWG #
8-Pin Plastic Small Outline (SO) Package	0 to +70°C	NE532D	SOT96-1
8-Pin Plastic Dual In-Line Package (DIP)	0 to +70°C	NE532N	SOT97-1
8-Pin Plastic Small Outline (SO) Package	-40°C to +85°C	SA532D	SOT96-1
8-Pin Plastic Dual In-Line Package (DIP)	-40°C to +85°C	SA532N	SOT97-1
8-Pin Ceramic Dual In-Line Package (CERDIP)	-40°C to +85°C	SA532FE	0580A
8-Pin Plastic Small Outline (SO) Package	-40°C to +125°C	LM2904D	SOT96-1
8-Pin Plastic Dual In-Line Package (DIP)	-40°C to +125°C	LM2904N	SOT97-1
8-Pin Ceramic Dual In-Line Package (CERDIP)	-55°C to +125°C	LM158FE	0580A
8-Pin Plastic Dual In-Line Package (DIP)	-25°C to +125°C	LM258N	SOT97-1
8-Pin Plastic Small Outline (SO) Package	-25°C to +125°C	LM258D	SOT96-1
8-Pin Plastic Small Outline (SO) Package	0 to +70°C	LM358D	SOT96-1
8-Pin Plastic Dual In-Line Package (DIP)	0 to +70°C	LM358N	SOT97-1
8-Pin Plastic Dual In-Line Package (DIP)	0 to +70°C	LM358AN	SOT97-1
8-Pin Plastic Small Outline (SO) Package	0 to +70°C	LM358AD	SOT96-1
8-Pin Plastic Dual In-Line Package (DIP)	-55°C to +125°C	SE532N	SOT97-1
8-Pin Ceramic Dual In-Line Package (CERDIP)	-55°C to +125°C	SE532FE	0580A

ABSOLUTE MAXIMUM RATINGS

SYMBOL	PARAMETER	RATING	UNIT
V _S	Supply voltage, V ₊	32 or ±16	V _{DC}
	Differential input voltage	32	V _{DC}
V _{IN}	Input voltage	-0.3 to +32	V _{DC}
P _D	Maximum power dissipation T _A =25°C (Still air) ¹		
	FE package	780	mW
	N package	1160	mW
	D package	780	mW
	Output short-circuit to GND ⁵ V ₊ <15 V _{DC} and T _A =25°C	Continuous	
T _A	Operating ambient temperature range		
	NE532/LM358/LM358A	0 to +70	°C
	LM258	-25 to +85	°C
	LM2904	-40 to +125	°C
	SA532	-40 to +85	°C
	SE532/LM158	-55 to +125	°C
T _{STG}	Storage temperature range	-65 to +150	°C
T _{SOLD}	Lead soldering temperature (10sec max)	300	°C

NOTES:

- Derate above 25°C, at the following rates:
FE package at 6.2mW/°C
N package at 9.3mW/°C
D package at 6.2mW/°C

Low power dual operational amplifiers

NE/SA/SE532/
LM158/258/358/A/2904

DC ELECTRICAL CHARACTERISTICS

T_A = 25°C, V₊ = +5V, unless otherwise specified.

SYMBOL	PARAMETER	TEST CONDITIONS	SE532, LM158/258			NE/SA532/ LM358/LM2904			UNIT
			Min	Typ	Max	Min	Typ	Max	
V _{OS}	Offset voltage ¹	R _S =0Ω R _S =0Ω, over temp.		±2	±5 ±7		±2	±7 ±9	mV mV
V _{OS}	Drift	R _S =0Ω, over temp.		7			7		μV/°C
I _{OS}	Offset current	I _{IN} (+)-I _{IN} (-) Over temp.		±3	±30 ±100		±5	±50 ±150	nA nA
I _{OS}	Drift	Over temp.		10			10		pA/°C
I _{BIAS}	Input current ²	I _{IN} (+) or I _{IN} (-) Over temp., I _{IN} (+) or I _{IN} (-)		45 40	150 300		45 40	250 500	nA nA
I _B	Drift	Over temp.		50			50		pA/°C
V _{CM}	Common-mode voltage range ³	V ₊ =30V Over temp., V ₊ =30V	0 0		V ₊ -1.5 V ₊ -2.0	0 0		V ₊ -1.5 V ₊ -2.0	V V
CMRR	Common-mode rejection ratio	V ₊ =30V	70	85		65	70		dB
V _{OH}	Output voltage swing	R _L ≥2kΩ, V ₊ =30V, over temp. R _L ≥10kΩ, V ₊ =30V, over temp.	26 27	28		26 27	28		V V
V _{OL}	Output voltage swing	R _L ≥10kΩ, over temp.		5	20		5	20	mV
I _{CC}	Supply current	R _L =∞, V ₊ =30V R _L =∞ on all amplifiers, over temp., V ₊ =30V		0.5 0.6	1.0 1.2		0.5 0.6	1.0 1.2	mA mA
A _{VOL}	Large-signal voltage gain	R _L ≥2kΩ, V _{OUT} ±10V, V ₊ =15V (for large V _O swing) over temp.	50 25	100		25 15	100		V/mV V/mV
PSRR	Supply voltage rejection ratio	R _S =0Ω	65	100		65	100		dB
	Amplifier-to-amplifier coupling ⁴	f=1kHz to 20kHz (input referred)		-120			-120		dB
I _{OUT}	Output current	V _{IN+} =+1V _{DC} , V _{IN-} =0V _{DC} , V ₊ =15V _{DC} V _{IN+} =+1V _{DC} , V _{IN-} =0V _{DC} , V ₊ =15V _{DC} , over temp. V _{IN-} =+1V _{DC} , V _{IN+} =0V _{DC} , V ₊ =15V _{DC} V _{IN-} =+1V _{DC} , V _{IN+} =0V _{DC} , V ₊ =15V _{DC} , over temp. V _{IN+} =0V, V _{IN-} =+1V _{DC} , V _O =200mV	20 10 10 5 12	40 20 20 8 50		20 10 10 5 12	40 20 20 8 50		mA mA mA mA μA
I _{SC}	Short circuit current ⁵			40	60		40	60	mA
	Differential input voltage ⁶				V ₊			V ₊	V
GBW	Unity gain bandwidth	T _A =25°C		1			1		MHz
SR	Slew rate	T _A =25°C		0.3			0.3		V/μs
V _{NOISE}	Input noise voltage	T _A =25°C, f=1kHz		40			40		nV/√Hz

Low power dual operational amplifiers

NE/SA/SE532/
LM158/258/358/A/2904**DC ELECTRICAL CHARACTERISTICS** $T_A=25^\circ\text{C}$, $V_{\pm}=+5\text{V}$, unless otherwise specified.

SYMBOL	PARAMETER	TEST CONDITIONS	LM358A			UNIT
			Min	Typ	Max	
V_{OS}	Offset voltage ¹	$R_S=0\Omega$ $R_S=0\Omega$, over temp.		± 2	± 3 ± 5	mV mV
V_{OS}	Drift	$R_S=0\Omega$, over temp.		7	20	$\mu\text{V}/^\circ\text{C}$
I_{OS}	Offset current	$I_{IN (+)}-I_{IN (-)}$ Over temp.		5	± 30 ± 75	nA nA
I_{OS}	Drift	Over temp.		10	300	$\text{pA}/^\circ\text{C}$
I_{BIAS}	Input current ²	$I_{IN (+)}$ or $I_{IN (-)}$ Over temp., $I_{IN (+)}$ or $I_{IN (-)}$		45 40	100 200	nA nA
I_B	Drift	Over temp.		50		$\text{pA}/^\circ\text{C}$
V_{CM}	Common-mode voltage range ³	$V_{\pm}=30\text{V}$ Over temp., $V_{\pm}=30\text{V}$	0 0		$V_{\pm}+1.5$ $V_{\pm}+2.0$	V V
CMRR	Common-mode rejection ratio	$V_{\pm}=30\text{V}$	65	85		dB
V_{OH}	Output voltage swing	$R_L \geq 2\text{k}\Omega$, $V_{\pm}=30\text{V}$, over temp. $R_L \geq 10\text{k}\Omega$, $V_{\pm}=30\text{V}$, over temp.	26 27	28		V V
V_{OL}	Output voltage swing	$R_L \geq 10\text{k}\Omega$, over temp.		5	20	mV
I_{CC}	Supply current	$R_L = \infty$, $V_{\pm}=30\text{V}$ $R_L = \infty$ on all amplifiers, over temp., $V_{\pm}=30\text{V}$		0.5 0.6	1.0 1.2	mA mA
A_{VOL}	Large-signal voltage gain	$R_L \geq 2\text{k}\Omega$, $V_{OUT} \pm 10\text{V}$, $V_{\pm}=15\text{V}$ (for large V_O swing) over temp.	25 15	100		V/mV V/mV
PSRR	Supply voltage rejection ratio	$R_S=0\Omega$	65	100		dB
	Amplifier-to-amplifier coupling ⁴	$f=1\text{kHz}$ to 20kHz (input referred)		-120		dB
I_{OUT}	Output current Source	$V_{IN+}=+1V_{DC}$, $V_{IN-}=0V_{DC}$, $V_{\pm}=15V_{DC}$	20	40		mA
		$V_{IN+}=+1V_{DC}$, $V_{IN-}=0V_{DC}$, $V_{\pm}=15V_{DC}$, over temp.	10	20		mA
	Sink	$V_{IN-}=+1V_{DC}$, $V_{IN+}=0V_{DC}$, $V_{\pm}=15V_{DC}$	10	20		mA
		$V_{IN-}=+1V_{DC}$, $V_{IN+}=0V_{DC}$, $V_{\pm}=15V_{DC}$, over temp.	5	8		mA
		$V_{IN+}=0\text{V}$, $V_{IN-}=+1V_{DC}$, $V_O=200\text{mV}$	12	50		μA
I_{SC}	Short circuit current ⁵			40	60	mA
	Differential input voltage ⁶				V_{\pm}	V
GBW	Unity gain bandwidth	$T_A=25^\circ\text{C}$		1		MHz
SR	Slew rate	$T_A=25^\circ\text{C}$		0.3		$\text{V}/\mu\text{s}$
V_{NOISE}	Input noise voltage	$T_A=25^\circ\text{C}$, $f=1\text{kHz}$		40		nV/Hz

NOTES:

- $V_O \approx 1.4\text{V}$, $R_S=0\Omega$ with V_{\pm} from 5V to 30V ; and over the full input common-mode range (0V to $V_{\pm} - 1.5\text{V}$).
- The direction of the input current is out of the IC due to the PNP input stage. This current is essentially constant, independent of the state of the output so no loading change exists on the input lines.
- The input common-mode voltage or either input signal voltage should not be allowed to go negative by more than 0.3V . The upper end of the common-mode voltage range is $V_{\pm} - 1.5\text{V}$, but either or both inputs can go to $+32\text{V}$ without damage.
- Due to proximity of external components, insure that coupling is not originating via stray capacitance between these external parts. This typically can be detected as this type of capacitance coupling increases at higher frequencies.
- Short-circuits from the output to V_{\pm} can cause excessive heating and eventual destruction. The maximum output current is approximately 40mA independent of the magnitude of V_{\pm} . At values of supply voltage in excess of $+15V_{DC}$, continuous short-circuits can exceed the power dissipation ratings and cause eventual destruction.
- The input common-mode voltage or either input signal voltage should not be allowed to go negative by more than 0.3V . The upper end of the common-mode voltage range is $V_{\pm} - 1.5\text{V}$, but either or both inputs can go to $+32V_{DC}$ without damage.

Low power dual operational amplifiers

NE/SA/SE532/
LM158/258/358/A/2904

TYPICAL PERFORMANCE CHARACTERISTICS

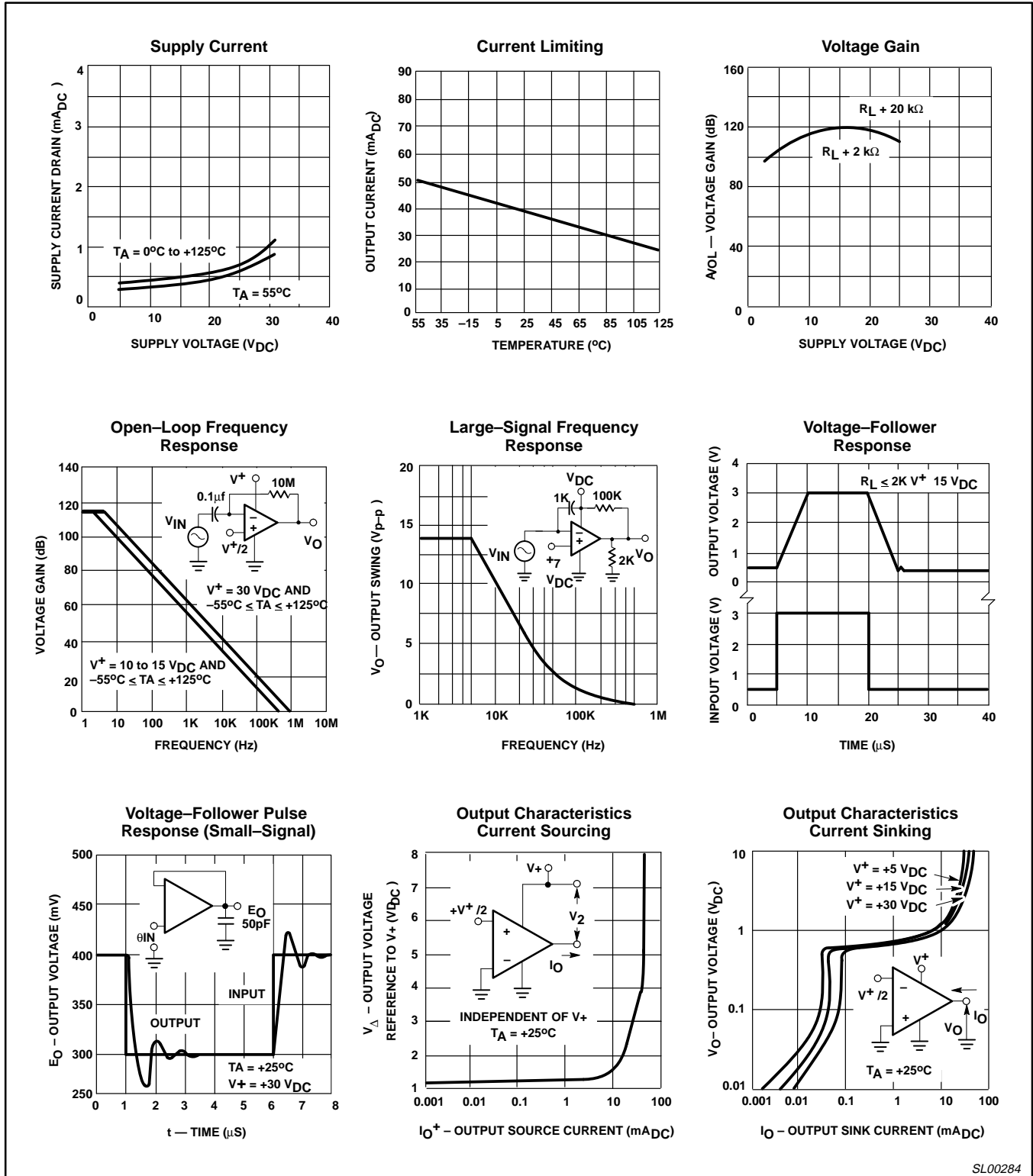

Figure 3. Typical Performance Characteristics

Low power dual operational amplifiers

NE/SA/SE532/
LM158/258/358/A/2904

TYPICAL PERFORMANCE CHARACTERISTICS (Continued)

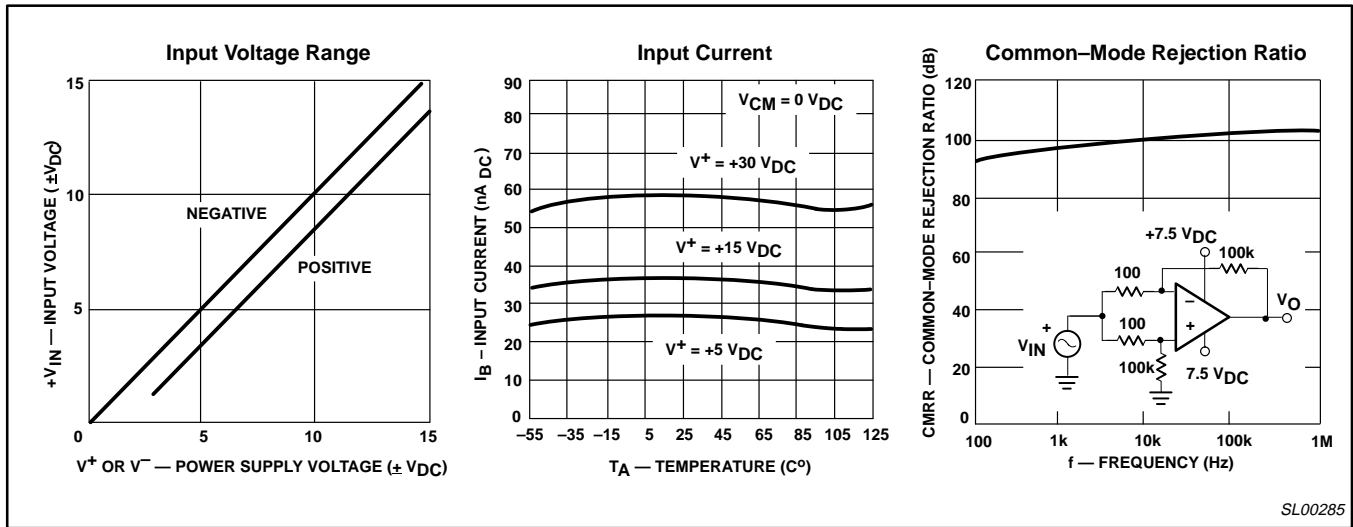

Figure 4. Typical Performance Characteristics (cont.)

TYPICAL APPLICATIONS

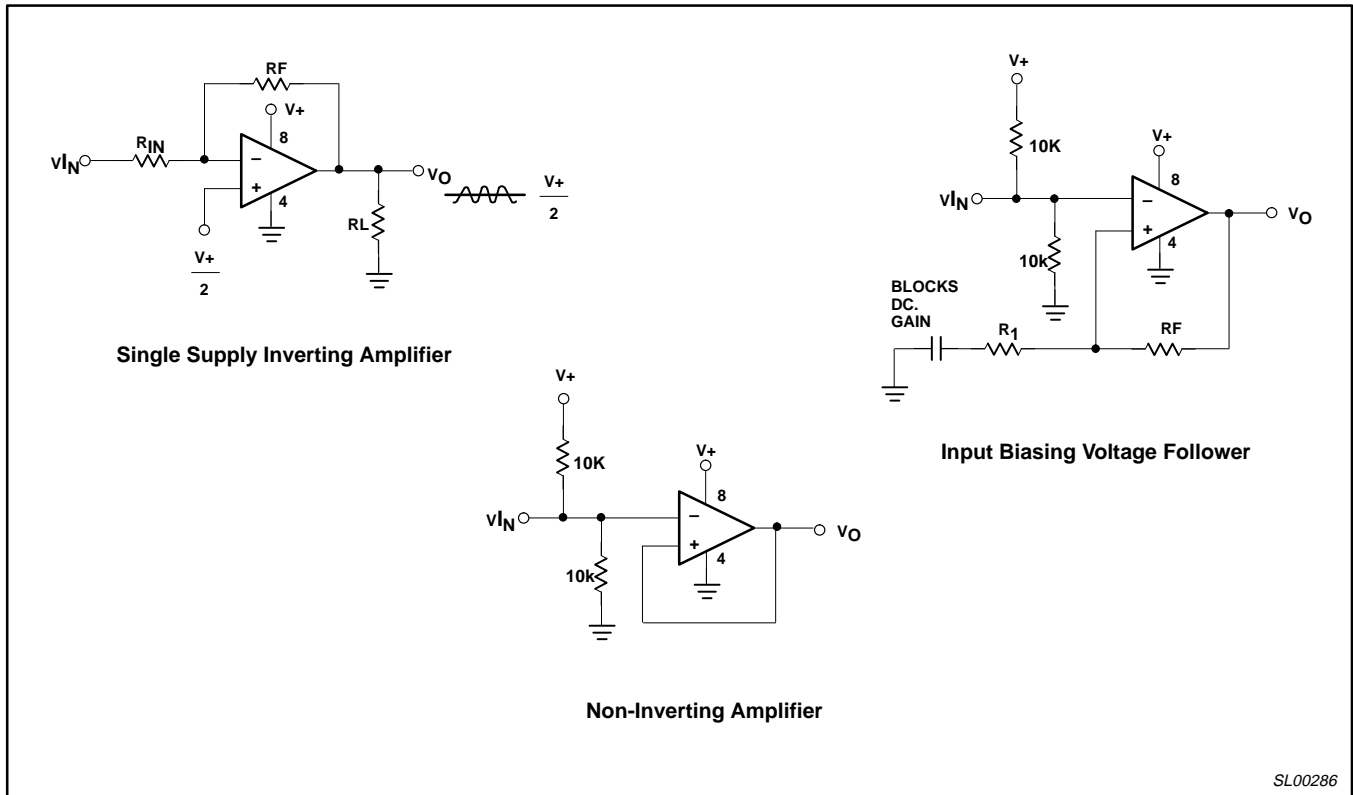

Figure 5. Typical Applications