

Quad voltage comparator

LM139/239/239A/339/339A /LM2901/MC3302

DESCRIPTION

The LM139 series consists of four independent precision voltage comparators, with an offset voltage specification as low as 2.0mV max for each comparator, which were designed specifically to operate from a single power supply over a wide range of voltages. Operation from split power supplies is also possible and the low power supply current drain is independent of the magnitude of the power supply voltage. These comparators also have a unique characteristic in that the input common-mode voltage range includes ground, even though they are operated from a single power supply voltage.

The LM139 series was designed to directly interface with TTL and CMOS. When operated from both plus and minus power supplies, the LM139 series will directly interface with MOS logic where their low power drain is a distinct advantage over standard comparators.

FEATURES

- Wide single supply voltage range 2.0V_{DC} to 36V_{DC} or dual supplies ±1.0V_{DC} to ±18V_{DC}
- Very low supply current drain (0.8mA) independent of supply voltage (1.0mW/comparator at 5.0V_{DC})
- Low input biasing current 25nA
- Low input offset current ±5nA and offset voltage
- Input common-mode voltage range includes ground
- Differential input voltage range equal to the power supply voltage
- Low output 250mV at 4mA saturation voltage
- Output voltage compatible with TTL, DTL, ECL, MOS and CMOS logic systems

APPLICATIONS

- A/D converters
- Wide range VCO
- MOS clock generator
- High voltage logic gate
- Multivibrators

PIN CONFIGURATION

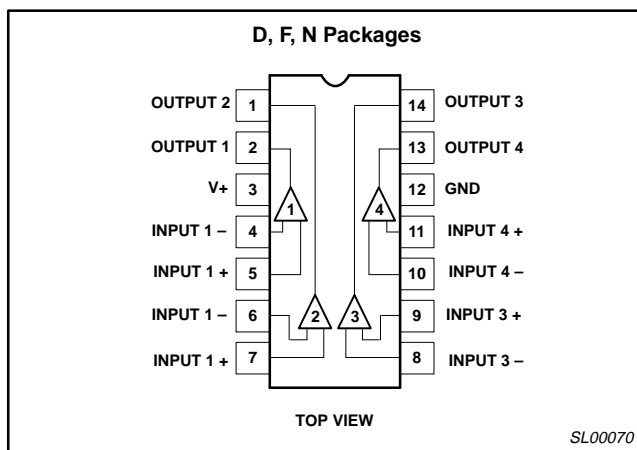

Figure 1. Pin Configuration

EQUIVALENT CIRCUIT

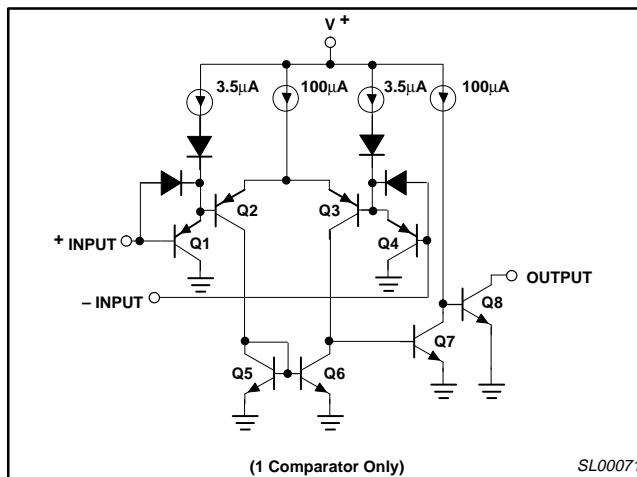

Figure 2. Equivalent Circuit

ORDERING INFORMATION

DESCRIPTION	TEMPERATURE RANGE	ORDER CODE	DWG #
14-Pin Ceramic Dual In-Line Package (Cerdip)	-55 to +125°C	LM139F	0581B
14-Pin Plastic Dual In-Line Package (DIP)	-25°C to +85°C	LM239AN	SOT27-1
14-Pin Plastic Dual In-Line Package (DIP)	-25°C to +85°C	LM239N	SOT27-1
14-Pin Plastic Small Outline (SO) Package	-25°C to +85°C	LM239D	SOT108-1
14-Pin Plastic Dual In-Line Package (DIP)	-40°C to +125°C	LM2901N	SOT27-1
14-Pin Plastic Small Outline (SO) Package	-40°C to +125°C	LM2901D	SOT108-1
14-Pin Plastic Dual In-Line Package (DIP)	0 to +70°C	LM339AN	SOT27-1
14-Pin Plastic Small Outline (SO) Package	0 to +70°C	LM339D	SOT108-1
14-Pin Plastic Dual In-Line Package (DIP)	0 to +70°C	LM339N	SOT27-1
14-Pin Plastic Small Outline (SO) Package	-40°C to +85°C	MC3302D	SOT108-1
14-Pin Ceramic Dual In-Line Package (Cerdip)	-40°C to +85°C	MC3302F	0581B
14-Pin Plastic Dual In-Line Package (DIP)	-40°C to +85°C	MC3302N	SOT27-1
14-Pin Plastic Dual In-Line Package (DIP)	-55 to +125°C	LM139N	SOT27-1

Quad voltage comparator

LM139/239/239A/339/339A/
LM2901/MC3302

ABSOLUTE MAXIMUM RATINGS

SYMBOL	PARAMETER	RATING	UNIT
V_{CC}	V_{CC} supply voltage	36 or ± 18	V_{DC}
V_{DIFF}	Differential input voltage	36	V_{DC}
V_{IN}	Input voltage	-0.3 to +36	V_{DC}
P_D	Maximum power dissipation, $T_A=25^\circ\text{C}$ (still-air) ¹		
	F package	1190	mW
	N package	1420	mW
	D package	1040	mW
	Output short-circuit to ground ²	Continuous	
I_{IN}	Input current ($V_{IN} < -0.3V_{DC}$) ³	50	mA
T_A	Operating temperature range		
	LM139	-55 to +125	$^\circ\text{C}$
	LM239/239A	-25 to +85	$^\circ\text{C}$
	LM339/339A	0 to +70	$^\circ\text{C}$
	LM2901	-40 to +125	$^\circ\text{C}$
MC3302	-40 to +85	$^\circ\text{C}$	
T_{STG}	Storage temperature range	-65 to +150	$^\circ\text{C}$
T_{SOLD}	Lead soldering temperature (10sec max)	300	$^\circ\text{C}$

NOTES:

- Derate above 25°C , at the following rates:
 F Package at $9.5\text{mW}/^\circ\text{C}$
 N Package at $11.4\text{mW}/^\circ\text{C}$
 D Package at $8.3\text{mW}/^\circ\text{C}$
- Short circuits from the output to $V+$ can cause excessive heating and eventual destruction. The maximum output current is approximately 20mA independent of the magnitude of $V+$.
- This input current will only exist when the voltage at any of the input leads is driven negative. It is due to the collector-base junction of the input PNP transistors becoming forward biased and thereby acting as input diode clamps. In addition to this diode action, there is also lateral NPN parasitic transistor action on the IC chip. This transistor action can cause the output voltages of the comparators to go to the $V+$ voltage level (or to ground for a large overdrive) for the time duration that an input is driven negative. This is not destructive and normal output states will reestablish when the input voltage, which was negative, again returns to a value greater than $-0.3V_{DC}$.

Quad voltage comparator

LM139/239/239A/339/339A/
LM2901/MC3302**DC AND AC ELECTRICAL CHARACTERISTICS**

$V_{+}=5V_{DC}$, LM139: $-55^{\circ}\text{C} \leq T_A \leq 125^{\circ}\text{C}$; LM239/239A: $-25^{\circ}\text{C} \leq T_A \leq 85^{\circ}\text{C}$; LM339/339A: $0^{\circ}\text{C} \leq T_A \leq 70^{\circ}\text{C}$; LM2901: $-40^{\circ}\text{C} \leq T_A \leq 125^{\circ}\text{C}$, MC3302: $-40^{\circ}\text{C} \leq T_A \leq 85^{\circ}\text{C}$, unless otherwise specified.

SYMBOL	PARAMETER	TEST CONDITIONS	LM239A/339A			UNIT
			Min	Typ	Max	
V_{OS}	Input offset voltage ²	$T_A=25^{\circ}\text{C}$ Over temp.		± 1.0	± 2.0 ± 4.0	mV mV
V_{CM}	Input common-mode voltage range ³	$T_A=25^{\circ}\text{C}$ Over temp.	0 0		$V_{+}-1.5$ $V_{+}-2.0$	V
V_{IDR}	Differential input voltage ¹	Keep all $V_{IN^S} \geq 0V_{DC}$ (or V_{-} if need)			V_{+}	V
I_{BIAS}	Input bias current ⁴	$I_{IN(+)}$ or $I_{IN(-)}$ with output in linear range $T_A=25^{\circ}\text{C}$ Over temp.		25	250 400	nA nA
I_{OS}	Input offset current	$I_{IN(+)} - I_{IN(-)}$ $T_A=25^{\circ}\text{C}$ Over temp.		± 5.0	± 50 ± 150	nA nA
I_{OL}	Output sink current	$V_{IN(-)} \geq 1V_{DC}$, $V_{IN(+)}=0$, $V_O \leq 1.5V_{DC}$, $T_A=25^{\circ}\text{C}$	6.0	16		mA
	Output leakage current	$V_{IN(+)} \geq 1V_{DC}$, $V_{IN(-)}=0$ $V_O=5V_{DC}$, $T_A=25^{\circ}\text{C}$ $V_O=30V_{DC}$, over temp.		0.1	1.0	nA μA
I_{CC}	Supply current	$R_L=\infty$ on comparators, $T_A=25^{\circ}\text{C}$ $V_{+}=30V$		0.8	2.0	mA
A_V	Voltage gain	$R_L \geq 15k\Omega$, $V_{+}=15V_{DC}$	50	200		V/mV
V_{OL}	Saturation voltage	$V_{IN(-)} \geq 1V_{DC}$, $V_{IN(+)}=0$, $I_{SINK} \leq 4\text{mA}$ $T_A=25^{\circ}\text{C}$ Over temp.		250	400 700	mV mV
t_{LSR}	Large-signal response time	$V_{IN}=\text{TTL logic swing}$, $V_{REF}=1.4V_{DC}$, $V_{RL}=5V_{DC}$, $R_L=5.1k\Omega$, $T_A=25^{\circ}\text{C}$		300		ns
t_R	Response time ⁵	$V_{RL}=5V_{DC}$, $R_L=5.1k\Omega$, $T_A=25^{\circ}\text{C}$		1.3		μs

See notes at the end of the Electrical Characteristics.

Quad voltage comparator

LM139/239/239A/339/339A/
LM2901/MC3302

DC AND AC ELECTRICAL CHARACTERISTICS

$V_{+}=5V_{DC}$, LM139: $-55^{\circ}\text{C} \leq T_A \leq 125^{\circ}\text{C}$; LM239/239A: $-25^{\circ}\text{C} \leq T_A \leq 85^{\circ}\text{C}$; LM339/339A: $0^{\circ}\text{C} \leq T_A \leq 70^{\circ}\text{C}$; LM2901: $-40^{\circ}\text{C} \leq T_A \leq 125^{\circ}\text{C}$, MC3302: $-40^{\circ}\text{C} \leq T_A \leq 85^{\circ}\text{C}$, unless otherwise specified.

SYMBOL	PARAMETER	TEST CONDITIONS	LM139			LM239/339			UNIT
			Min	Typ	Max	Min	Typ	Max	
V_{OS}	Input offset voltage ²	$T_A=25^{\circ}\text{C}$ Over temp.		± 2.0	± 5.0 ± 9.0		± 2.0	± 5.0 ± 9.0	mV mV
V_{CM}	Input common-mode voltage range ³	$T_A=25^{\circ}\text{C}$ Over temp.	0 0		$V_{+}-1.5$ $V_{+}-2.0$	0 0		$V_{+}-1.5$ $V_{+}-2.0$	V
V_{IDR}	Differential input voltage ¹	Keep all $V_{IN}^S \geq 0V_{DC}$ (or V_{-} if need)			V_{+}			V_{+}	V
I_{BIAS}	Input bias current ⁴	$I_{IN(+)}$ or $I_{IN(-)}$ with output in linear range $T_A=25^{\circ}\text{C}$ Over temp.		25	100 300		25	250 400	nA nA
I_{OS}	Input offset current	$I_{IN(+)} - I_{IN(-)}$ $T_A=25^{\circ}\text{C}$ Over temp.		± 3.0	± 25 ± 100		± 5.0	± 50 ± 150	nA nA
I_{OL}	Output sink current	$V_{IN(-)} \geq 1V_{DC}$, $V_{IN(+)}=0$, $V_O \leq 1.5V_{DC}$, $T_A=25^{\circ}\text{C}$	6.0	16		6.0	16		mA
	Output leakage current	$V_{IN(+)} \geq 1V_{DC}$, $V_{IN(-)}=0$ $V_O=5V_{DC}$, $T_A=25^{\circ}\text{C}$ $V_O=30V_{DC}$, over temp.		0.1	1.0		0.1	1.0	nA μA
I_{CC}	Supply current	$R_L=\infty$ on comparators, $T_A=25^{\circ}\text{C}$ $V_{+}=30\text{V}$		0.8	2.0		0.8	2.0	mA
A_V	Voltage gain	$R_L \geq 15\text{k}\Omega$, $V_{+}=15V_{DC}$	50	200		50	200		V/mV
V_{OL}	Saturation voltage	$V_{IN(-)} \geq 1V_{DC}$, $V_{IN(+)}=0$, $I_{SINK} \leq 4\text{mA}$ $T_A=25^{\circ}\text{C}$ Over temp.		250	400 700		250	400 700	mV mV
t_{LSR}	Large-signal response time	$V_{IN}=\text{TTL logic swing}$, $V_{REF}=1.4V_{DC}$, $V_{RL}=5V_{DC}$, $R_L=5.1\text{k}\Omega$, $T_A=25^{\circ}\text{C}$		300			300		ns
t_R	Response time ⁵	$V_{RL}=5V_{DC}$, $R_L=5.1\text{k}\Omega$, $T_A=25^{\circ}\text{C}$		1.3			1.3		μs

See notes on following page.

Quad voltage comparator

LM139/239/239A/339/339A/
LM2901/MC3302

DC AND AC ELECTRICAL CHARACTERISTICS

$V_+ = 5V_{DC}$, LM139: $-55^\circ\text{C} \leq T_A \leq 125^\circ\text{C}$; LM239/239A: $-25^\circ\text{C} \leq T_A \leq 85^\circ\text{C}$; LM339/339A: $0^\circ\text{C} \leq T_A \leq 70^\circ\text{C}$; LM2901: $-40^\circ\text{C} \leq T_A \leq 125^\circ\text{C}$, MC3302: $-40^\circ\text{C} \leq T_A \leq 85^\circ\text{C}$, unless otherwise specified.

SYMBOL	PARAMETER	TEST CONDITIONS	LM2901			MC3302			UNIT
			Min	Typ	Max	Min	Typ	Max	
V_{OS}	Input offset voltage ²	$T_A = 25^\circ\text{C}$ Over temp.		± 2.0 ± 9	± 7.0 ± 15		± 3.0 ± 20 ± 40	mV mV	
V_{CM}	Input common-mode voltage range ³	$T_A = 25^\circ\text{C}$ Over temp.	0 0		$V_+ - 1.5$ $V_+ - 2.0$	0 0	$V_+ - 1.5$ $V_+ - 2.0$	V	
V_{IDR}	Differential input voltage ¹	Keep all $V_{IN} \geq 0V_{DC}$ (or V_- if need)			V_+		V_+	V	
I_{BIAS}	Input bias current ⁴	$I_{IN(+)}$ or $I_{IN(-)}$ with output in linear range $T_A = 25^\circ\text{C}$ Over temp.		25 200	250 500		25 500 1000	nA nA	
I_{OS}	Input offset current	$I_{IN(+)} - I_{IN(-)}$ $T_A = 25^\circ\text{C}$ Over temp.		± 5 ± 50	± 50 ± 200		± 5 ± 100 ± 300	nA nA	
I_{OL}	Output sink current	$V_{IN(-)} \geq 1V_{DC}$, $V_{IN(+)} = 0$, $V_O \leq 1.5V_{DC}$, $T_A = 25^\circ\text{C}$	6.0	16		6	16	mA	
	Output leakage current	$V_{IN(+)} \geq 1V_{DC}$, $V_{IN(-)} = 0$ $V_O = 5V_{DC}$, $T_A = 25^\circ\text{C}$ $V_O = 30V_{DC}$, over temp.		0.1	1.0		0.1 1.0	nA μA	
I_{CC}	Supply current	$R_L = \infty$ on all comparators, $T_A = 25^\circ\text{C}$		0.8	2.0		.8	1.8	mA
		$R_L = \infty$ on all comparators, $V_+ = 30V$		1.0	2.5				mA
A_V	Voltage gain	$R_L \geq 15k\Omega$, $V_+ = 15V_{DC}$	25	100		2	100	V/mV	
V_{OL}	Saturation voltage	$V_{IN(-)} \geq 1V_{DC}$, $V_{IN(+)} = 0$, $I_{SINK} \leq 4\text{mA}$ $T_A = 25^\circ\text{C}$ Over temp.		400	400 700		150 400 700	mV mV	
t_{LSR}	Large-signal response time	$V_{IN} = \text{TTL logic swing}$, $V_{REF} = 1.4V_{DC}$, $V_{RL} = 5V_{DC}$, $R_L = 5.1k\Omega$, $T_A = 25^\circ\text{C}$		300			300	ns	
t_R	Response time ⁵	$V_{RL} = 5V_{DC}$, $R_L = 5.1k\Omega$, $T_A = 25^\circ\text{C}$		1.3			1.3	μs	

NOTES:

- Positive excursions of input voltage may exceed the power supply level by 17V. As long as the other voltage remains within the common-mode range, the comparator will provide a proper output state. The low input voltage state must not be less than $-0.3V_{DC}$ (or $0.3V_{DC}$ below the magnitude of the negative power supply, if used).
- At output switch point, $V_O \approx 1.4V_{DC}$, $R_S = 0\Omega$ with V_+ from $5V_{DC}$ to $30V_{DC}$; and over the full input common-mode range ($0V_{DC}$ to $V_+ - 1.5V_{DC}$). Inputs of unused comparators should be grounded.
- The input common-mode voltage or either input signal voltage should not be allowed to go negative by more than 0.3V. The upper end of the common-mode voltage range is $V_+ - 1.5V$, but either or both inputs can go to $30V_{DC}$ without damage.
- The direction of the input current is out of the IC due to the PNP input stage. This current is essentially constant, independent of the state of the output so no loading change exists on the reference or input lines.
- The response time specified is for a 100mV input step with a 5mV overdrive. For larger overdrive signals, 300ns can be obtained (see typical performance characteristics section).

Quad voltage comparator

LM139/239/239A/339/339A/ LM2901/MC3302

EQUIVALENT CIRCUIT

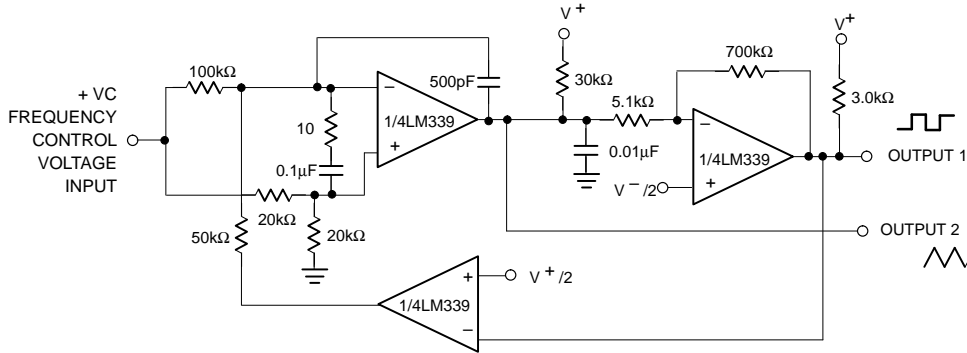

NOTES:
 $V^+ = 30V_{DC}$
 $+ 250mV_{DC} \leq V_C = 50V_{DC}$
 $700H \leq f_O = 100kHz$

Two-Decade High-Frequency VCO

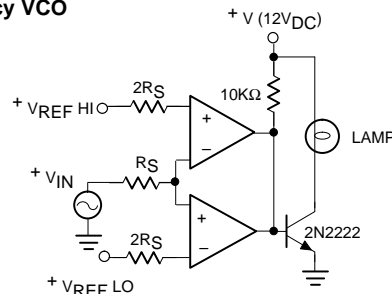

Limit Comparator

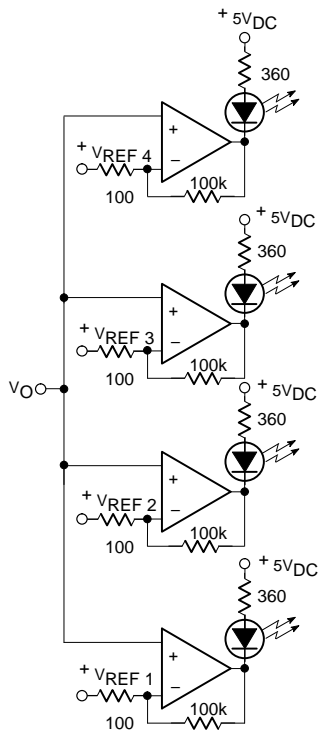

Visible Voltage Indicator

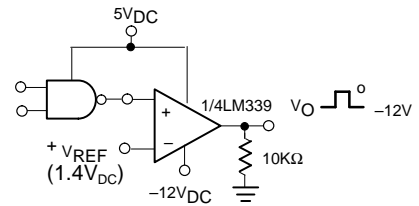

TTL-to-MOS Logic Converter

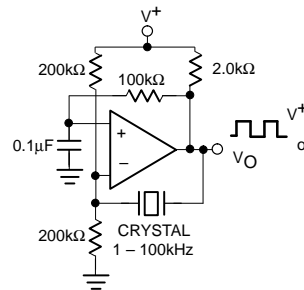

Crystal-Controlled Oscillator

NOTE:
 Input of unused comparators should be grounded.

SL00072

Figure 3. Equivalent Circuit

Quad voltage comparator

LM139/239/239A/339/339A/ LM2901/MC3302

TYPICAL PERFORMANCE CHARACTERISTICS

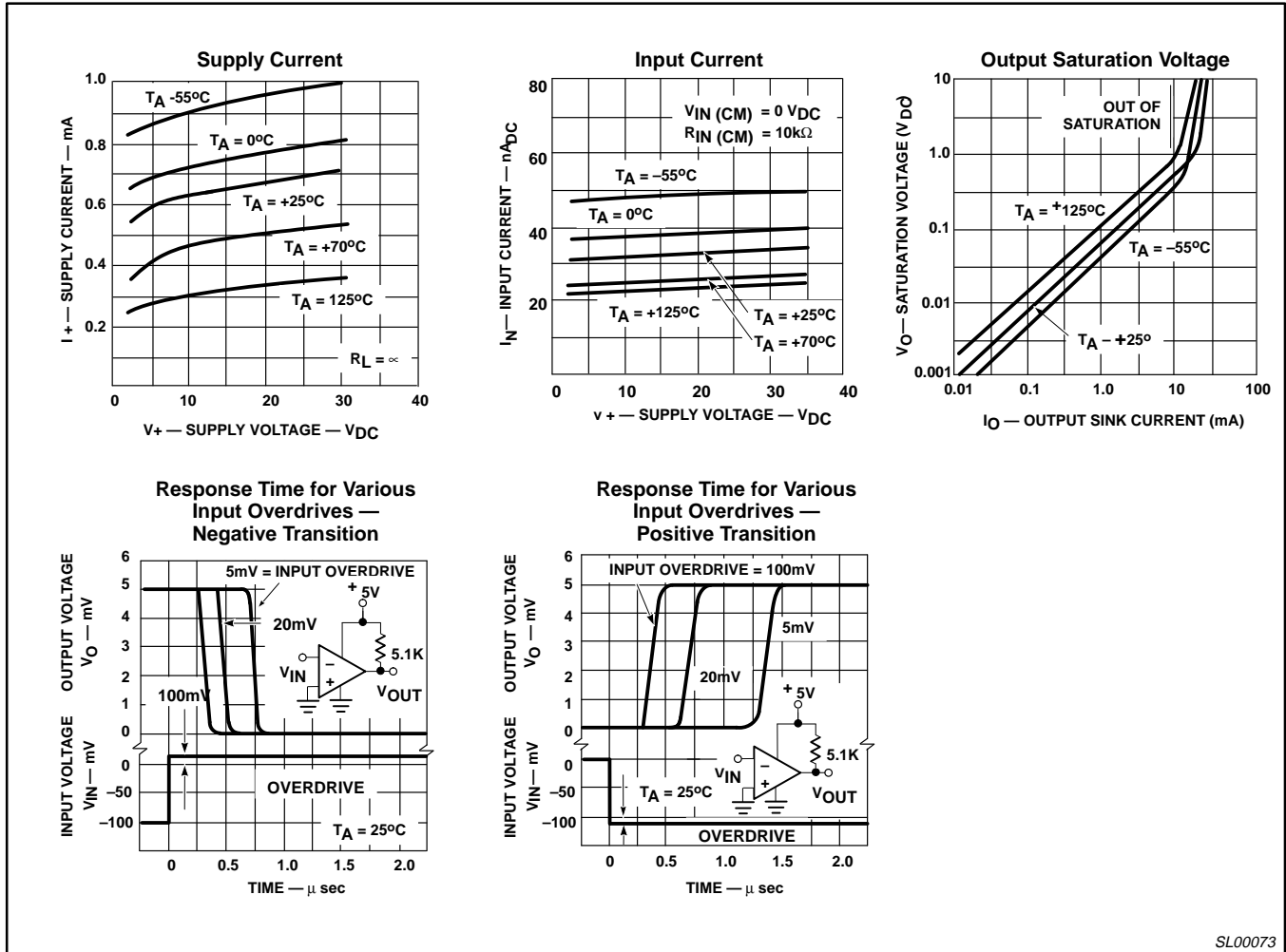

Figure 4. Typical Performance Characteristics