

# LM194/LM394 Supermatch Pair

## General Description

The LM194 and LM394 are junction isolated ultra well-matched monolithic NPN transistor pairs with an order of magnitude improvement in matching over conventional transistor pairs. This was accomplished by advanced linear processing and a unique new device structure.

Electrical characteristics of these devices such as drift versus initial offset voltage, noise, and the exponential relationship of base-emitter voltage to collector current closely approach those of a theoretical transistor. Extrinsic emitter and base resistances are much lower than presently available pairs, either monolithic or discrete, giving extremely low noise and theoretical operation over a wide current range. Most parameters are guaranteed over a current range of 1  $\mu$ A to 1 mA and 0V up to 40V collector-base voltage, ensuring superior performance in nearly all applications.

To guarantee long term stability of matching parameters, internal clamp diodes have been added across the emitter-base junction of each transistor. These prevent degradation due to reverse biased emitter current—the most common cause of field failures in matched devices. The parasitic isolation junction formed by the diodes also clamps the substrate region to the most negative emitter to ensure complete isolation between devices.

The LM194 and LM394 will provide a considerable improvement in performance in most applications requiring a closely

matched transistor pair. In many cases, trimming can be eliminated entirely, improving reliability and decreasing costs. Additionally, the low noise and high gain make this device attractive even where matching is not critical.

The LM194 and LM394/LM394B/LM394C are available in an isolated header 6-lead TO-5 metal can package. The LM394/LM394B/LM394C are available in an 8-pin plastic dual-in-line package. The LM394C is also available in a 8 pin plastic dual-in-line package. The LM194 is identical to the LM394 except for tighter electrical specifications and wider temperature range.

## Features

- Emitter-base voltage matched to 50  $\mu$ V
- Offset voltage drift less than 0.1  $\mu$ V/ $^{\circ}$ C
- Current gain ( $h_{FE}$ ) matched to 2%
- Common-mode rejection ratio greater than 120 dB
- Parameters guaranteed over 1  $\mu$ A to 1 mA collector current
- Extremely low noise
- Superior logging characteristics compared to conventional pairs
- Plug-in replacement for presently available devices

## Typical Applications

**Low Cost Accurate Square Root Circuit**

$$I_{OUT} = 10^{-5} \cdot \sqrt{10 V_{IN}}$$

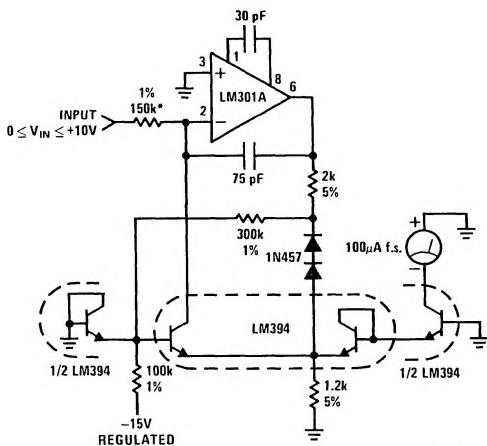

TL/H/9241-1  
\*Trim for full scale accuracy

**Low Cost Accurate Squaring Circuit**

$$I_{OUT} = 10^{-6} (V_{IN})^2$$

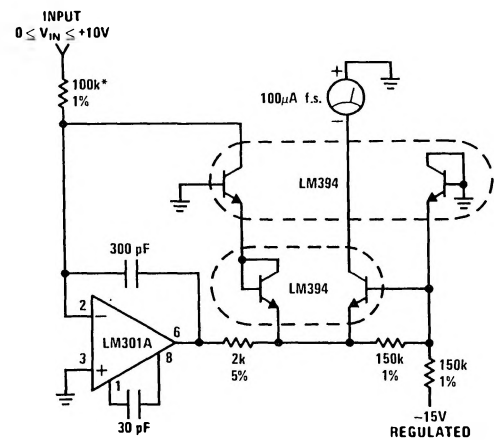

TL/H/9241-2

## Absolute Maximum Ratings

If Military/Aerospace specified devices are required, contact the National Semiconductor Sales Office/Distributors for availability and specifications. (Note 4)

Collector Current	20 mA
Collector-Emitter Voltage	$V_{MAX}$
Collector-Emitter Voltage LM394C	40V 20V
Collector-Base Voltage LM394C	40V 20V
Collector-Substrate Voltage LM394C	40V 20V
Collector-Collector Voltage LM394C	40V 20V

Base-Emitter Current	$\pm 10$ mA
Power Dissipation	500 mW
Junction Temperature	
LM194	$-55^{\circ}\text{C}$ to $+125^{\circ}\text{C}$
LM394/LM394B/LM394C	$-25^{\circ}\text{C}$ to $+85^{\circ}\text{C}$
Storage Temperature Range	$-65^{\circ}\text{C}$ to $+150^{\circ}\text{C}$
Soldering Information	
Metal Can Package (10 sec.)	$260^{\circ}\text{C}$
Dual-In-Line Package (10 sec.)	$260^{\circ}\text{C}$
Small Outline Package	
Vapor Phase (60 sec.)	$215^{\circ}\text{C}$
Infrared (15 sec.)	$220^{\circ}\text{C}$
See AN-450 "Surface Mounting and their Effects on Product Reliability" for other methods of soldering surface mount devices.	

## Electrical Characteristics ( $T_J = 25^{\circ}\text{C}$ )

Parameter	Conditions	LM194			LM394			LM394B/394C			Units
		Min	Typ	Max	Min	Typ	Max	Min	Typ	Max	
Current Gain ( $h_{FE}$ )	$V_{CB} = 0\text{V}$ to $V_{MAX}$ (Note 1)										
	$I_C = 1\text{ mA}$	500	700		300	700		225	500		
	$I_C = 100\ \mu\text{A}$	400	550		250	550		200	400		
	$I_C = 10\ \mu\text{A}$	300	450		200	450		150	300		
	$I_C = 1\ \mu\text{A}$	200	300		150	300		100	200		
Current Gain Match, ( $h_{FE}$ Match) $= \frac{100 [\Delta I_B] [h_{FE(MIN)}]}{I_C}$	$V_{CB} = 0\text{V}$ to $V_{MAX}$		0.5	2		0.5	4		1.0	5	%
	$I_C = 10\ \mu\text{A}$ to $1\text{ mA}$ $I_C = 1\ \mu\text{A}$		1.0			1.0			2.0		%
Emitter-Base Offset Voltage	$V_{CB} = 0$ $I_C = 1\ \mu\text{A}$ to $1\text{ mA}$		25	50		25	150		50	200	$\mu\text{V}$
Change in Emitter-Base Offset Voltage vs Collector-Base Voltage (CMRR)	(Note 1) $I_C = 1\ \mu\text{A}$ to $1\text{ mA}$ , $V_{CB} = 0\text{V}$ to $V_{MAX}$		10	25		10	50		10	100	$\mu\text{V}$
Change in Emitter-Base Offset Voltage vs Collector Current	$V_{CB} = 0\text{V}$ , $I_C = 1\ \mu\text{A}$ to $0.3\text{ mA}$		5	25		5	50		5	50	$\mu\text{V}$
Emitter-Base Offset Voltage Temperature Drift	$I_C = 10\ \mu\text{A}$ to $1\text{ mA}$ (Note 2)		0.08	0.3		0.08	1.0		0.2	1.5	$\mu\text{V}/^{\circ}\text{C}$
	$I_{C1} = I_{C2}$ $V_{OS}$ Trimmed to 0 at $25^{\circ}\text{C}$		0.03	0.1		0.03	0.3		0.03	0.5	$\mu\text{V}/^{\circ}\text{C}$
Logging Conformity	$I_C = 3\text{ nA}$ to $300\ \mu\text{A}$ , $V_{CB} = 0$ , (Note 3)		150			150			150		$\mu\text{V}$
Collector-Base Leakage	$V_{CB} = V_{MAX}$		0.05	0.25		0.05	0.5		0.05	0.5	nA
Collector-Collector Leakage	$V_{CC} = V_{MAX}$		0.1	2.0		0.1	5.0		0.1	5.0	nA
Input Voltage Noise	$I_C = 100\ \mu\text{A}$ , $V_{CB} = 0\text{V}$ , $f = 100\text{ Hz}$ to $100\text{ kHz}$		1.8			1.8			1.8		$\text{nV}/\sqrt{\text{Hz}}$
Collector to Emitter Saturation Voltage	$I_C = 1\text{ mA}$ , $I_B = 10\ \mu\text{A}$		0.2			0.2			0.2		V
	$I_C = 1\text{ mA}$ , $I_B = 100\ \mu\text{A}$		0.1			0.1			0.1		V

Note 1: Collector-base voltage is swept from 0 to  $V_{MAX}$  at a collector current of  $1\ \mu\text{A}$ ,  $10\ \mu\text{A}$ ,  $100\ \mu\text{A}$ , and  $1\text{ mA}$ .

Note 2: Offset voltage drift with  $V_{OS} = 0$  at  $T_A = 25^{\circ}\text{C}$  is valid only when the ratio of  $I_{C1}$  to  $I_{C2}$  is adjusted to give the initial zero offset. This ratio must be held to within 0.003% over the entire temperature range. Measurements taken at  $\pm 25^{\circ}\text{C}$  and temperature extremes.

Note 3: Logging conformity is measured by computing the best fit to a true exponential and expressing the error as a base-emitter voltage deviation.

Note 4: Refer to RETS194X drawing of military LM194H version for specifications.

Typical Applications (Continued)

Fast, Accurate Logging Amplifier,  $V_{IN} = 10V$  to  $0.1\text{ mV}$  or  $I_{IN} = 1\text{ mA}$  to  $10\text{ nA}$

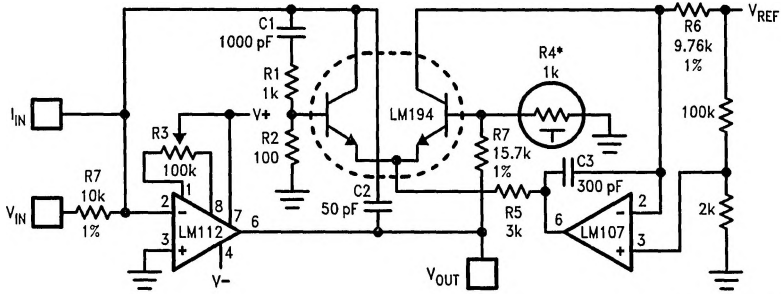

TL/H/9241-3

\*Tel Labs type Q81 + 0.3%/°C

$$V_{OUT} = -\log_{10} \left( \frac{V_{IN}}{V_{REF}} \right)$$

Voltage Controlled Variable Gain Amplifier

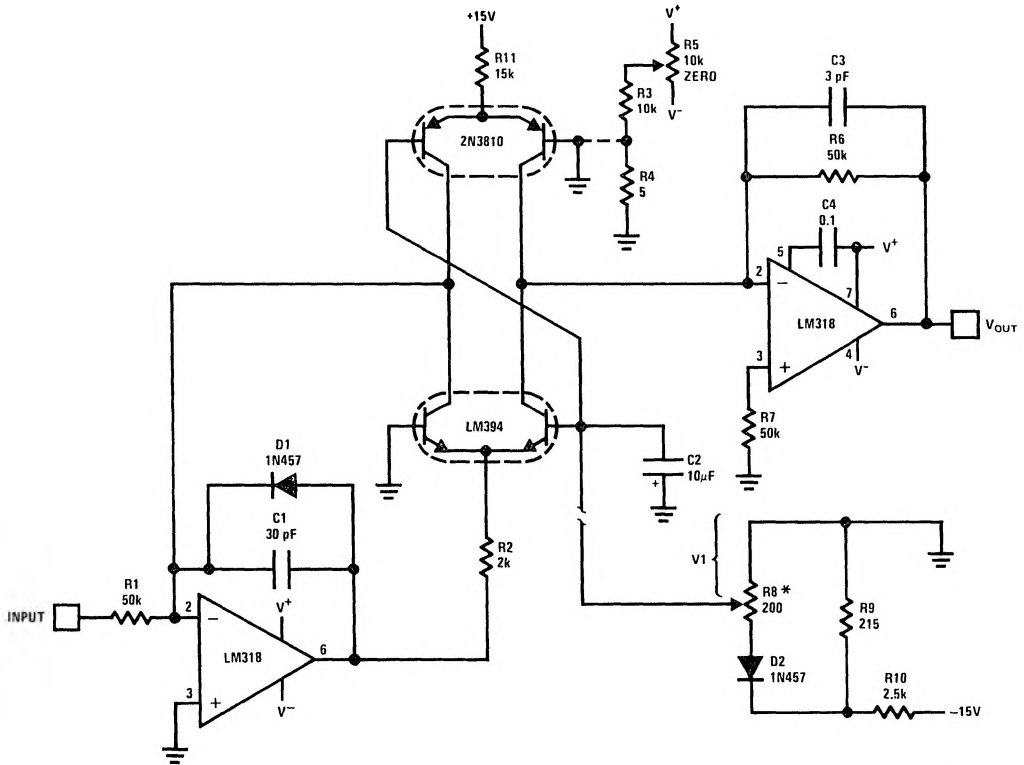

TL/H/9241-4

\*R8-R10 and D2 provide a temperature independent gain control.  
 $G = -336 V_1$  (dB)

Distortion < 0.1%  
 Bandwidth > 1 MHz  
 100 dB gain range

# Typical Applications (Continued)

## Precision Low Drift Operational Amplifier

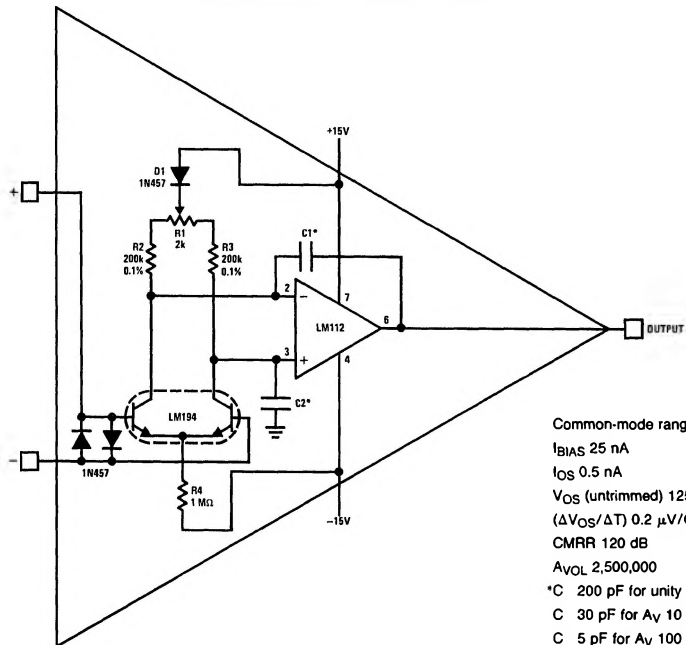

- Common-mode range 10V
- I<sub>BIAS</sub> 25 nA
- I<sub>OS</sub> 0.5 nA
- V<sub>OS</sub> (untrimmed) 125 μV
- (ΔV<sub>OS</sub>/ΔT) 0.2 μV/°C
- CMRR 120 dB
- A<sub>VOL</sub> 2,500,000
- \*C 200 pF for unity gain
- C 30 pF for A<sub>v</sub> 10
- C 5 pF for A<sub>v</sub> 100
- C 0 pF for A<sub>v</sub> 1000

TL/H/9241-5

## High Accuracy One Quadrant Multiplier/Divider

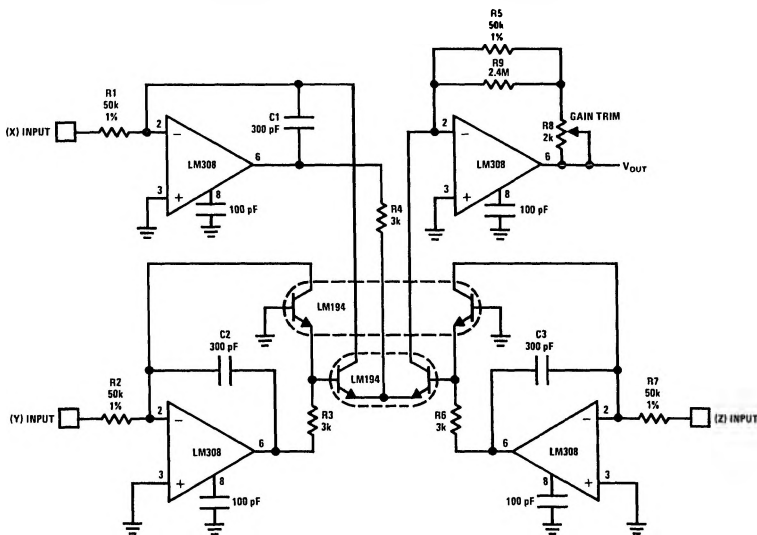

$$V_{OUT} = \frac{(X)(Y)}{(Z)}; \text{ positive inputs only.}$$

\*Typical linearity 0.1%

TL/H/9241-6

## Typical Applications (Continued)

## High Performance Instrumentation Amplifier

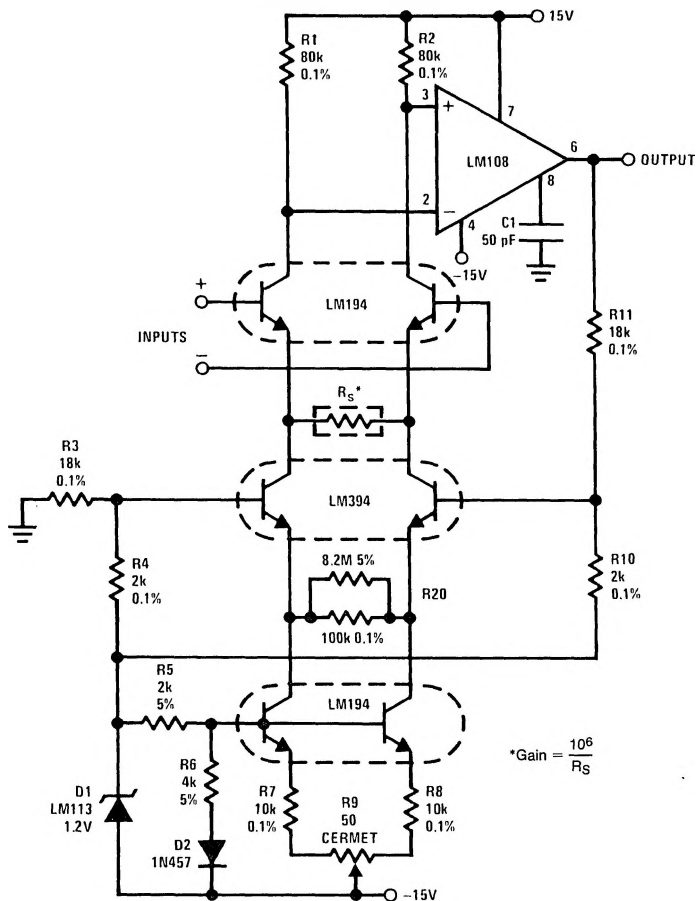

TL/H/9241-7

## Performance Characteristics

 $G = 10,000 \quad G = 1,000 \quad G = 100 \quad G = 10$ 

Linearity of Gain ( $\pm 10V$ Output)	$\leq 0.01$	$\leq 0.01$	$\leq 0.02$	$\leq 0.05$	%
Common-Mode Rejection Ratio (60 Hz)	$\geq 120$	$\geq 120$	$\geq 110$	$\geq 90$	dB
Common-Mode Rejection Ratio (1 kHz)	$\geq 110$	$\geq 110$	$\geq 90$	$\geq 70$	dB
Power Supply Rejection Ratio					
+ Supply	$> 110$	$> 110$	$> 110$	$> 110$	dB
- Supply	$> 110$	$> 110$	$> 90$	$> 70$	dB
Bandwidth ( $-3$ dB)	50	50	50	50	kHz
Slew Rate	0.3	0.3	0.3	0.3	V/ $\mu$ s
Offset Voltage Drift**	$\leq 0.25$	$\leq 0.4$	2	$\leq 10$	$\mu$ V/ $^{\circ}$ C
Common-Mode Input Resistance	$> 10^9$	$> 10^9$	$> 10^9$	$> 10^9$	$\Omega$
Differential Input Resistance	$> 3 \times 10^8$	$> 3 \times 10^8$	$> 3 \times 10^8$	$> 3 \times 10^8$	$\Omega$
Input Referred Noise (100 Hz $\leq f \leq$ 10 kHz)	5	6	12	70	$\frac{nV}{\sqrt{Hz}}$
Input Bias Current	75	75	75	75	nA
Input Offset Current	1.5	1.5	1.5	1.5	nA
Common-Mode Range	$\pm 11$	$\pm 11$	$\pm 11$	$\pm 10$	V
Output Swing ( $R_L = 10$ k $\Omega$ )	$\pm 13$	$\pm 13$	$\pm 13$	$\pm 13$	V

\*\*Assumes  $\leq 5$  ppm/ $^{\circ}$ C tracking of resistors

# Typical Performance Characteristics

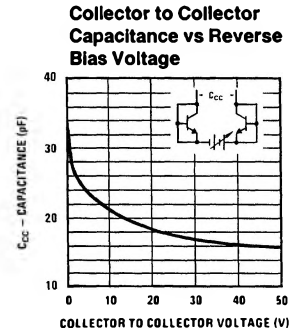
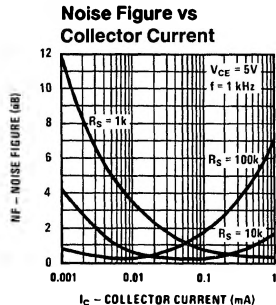
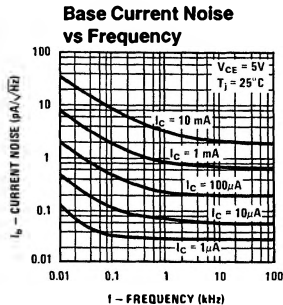
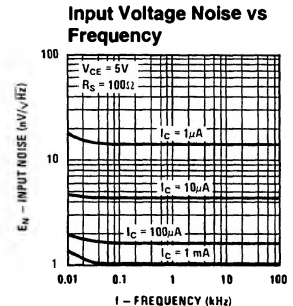
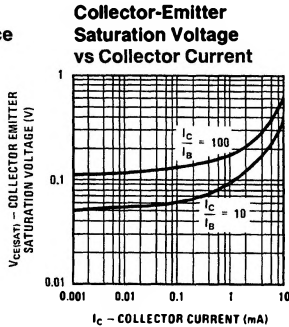
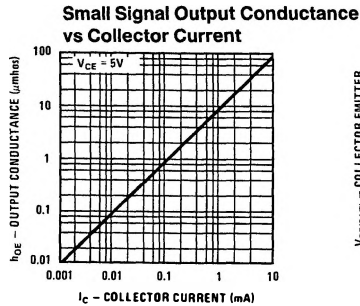
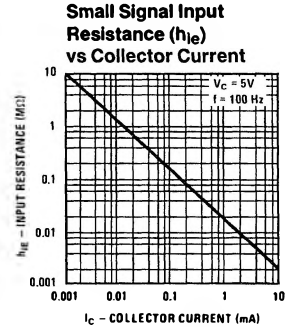
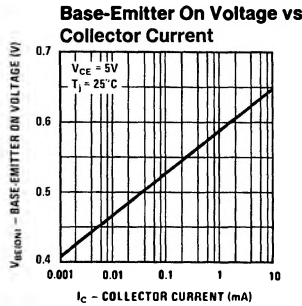
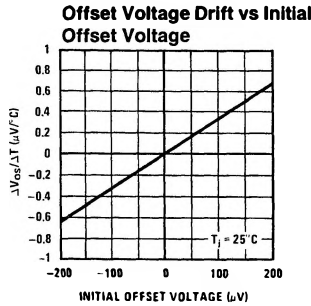
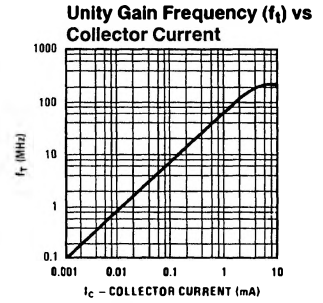
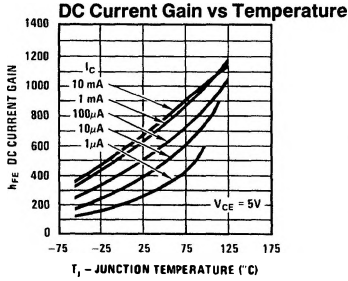
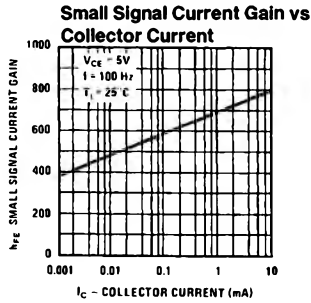

Typical Performance Characteristics (Continued)

Collector to Collector Capacitance vs Collector-Substrate Voltage

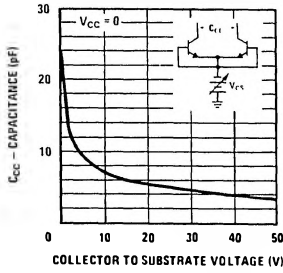

Emitter-Base Capacitance vs Reverse Bias Voltage

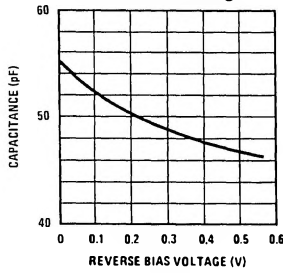

Collector-Base Capacitance vs Reverse Bias Voltage

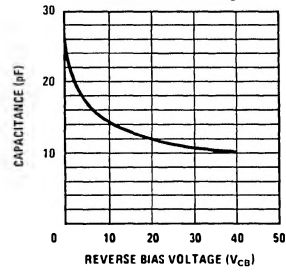

Collector-Base Leakage vs Temperature

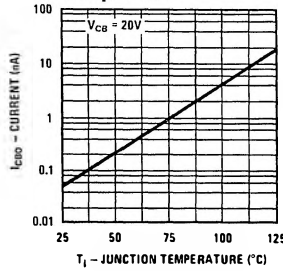

Collector to Collector Leakage vs Temperature

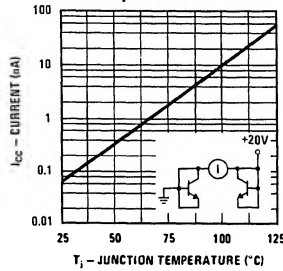

Offset Voltage Long Term Stability at High Temperature

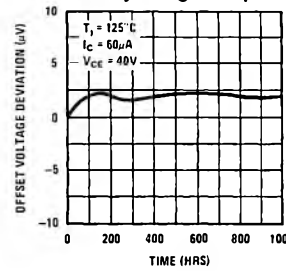

Emitter-Base Log Conformity

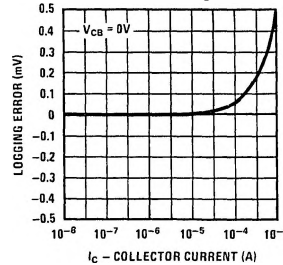

TL/H/9241-10

TL/H/9241-9

Low Frequency Noise of Differential Pair\*

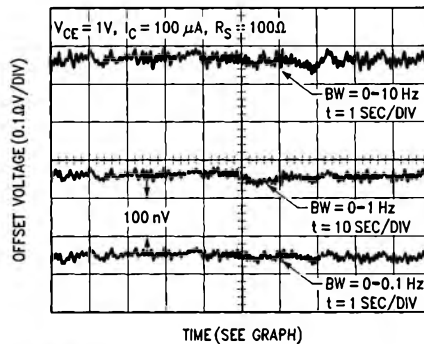

TL/H/9241-11

\*Unit must be in still air environment so that differential lead temperature is held to less than 0.0003°C.

# Connection Diagram

**Metal Can Package**

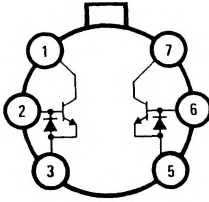

**Top View**

TL/H/9241-12

**Order Number LM194H, LM394H, LM394BH or LM394CH**  
**See NS Package Number H06C**

**Dual-In-Line and Small Outline Packages**

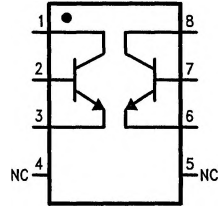

**Top View**

TL/H/9241-13

**Order Number LM394CM, LM394N, LM394BN or LM394CN**  
**See NS Package Number M08A or N08E**