

LM1921 1 Amp Industrial Switch

General Description

The LM1921 Relay Driver incorporates an integrated power PNP transistor as the main driving element. The advantages of this over previous integrated circuits employing NPN power elements are several. Greater output voltages are available off the same supply for driving grounded loads; typically 4.5 volts for a 500 mA load from a 5.0 volt supply. The output can swing below ground potential up to 57 volts negative with respect to the positive power supply. This can be used to facilitate rapid decay times in inductive loads. Also, the IC is immune to negative supply voltages or transients. The inherent Safe Operating Area of the lateral PNP allows use of the IC as a bulb driver or for capacitive loads.

Familiar integrated circuit features such as short circuit protection and thermal shutdown are also provided. The input voltage threshold levels are designed to be TTL, CMOS, and LSTTL compatible over the entire operating temperature range. If several drivers are used in a system, their inputs and/or outputs may be combined and wired together if their supply voltages are also common.

Features

- 1 Amp output drive
- Load connected to ground
- Low input-output voltage differential
- +60 volt positive transient protection
- -50 volt negative transient protection
- Automotive reverse battery protection
- Short circuit proof
- Internal thermal overload protection
- Unclamped output for fast decay times
- TTL, LSTTL, CMOS compatible input
- Plastic TO-220 package
- 100% electrical burn-in

Applications

- Relays
- Solenoids
- Valves
- Motors
- Lamps
- Heaters

Typical Application Circuit

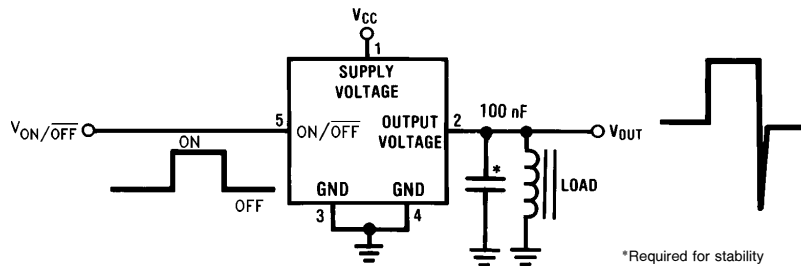
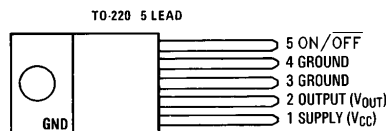

FIGURE 1. Test and Application Circuit

TL/H/5271-1

Connection Diagram



TL/H/5271-2

Front View
 Order Number LM1921T
 See NS Package Number T05A

Absolute Maximum Ratings

If Military/Aerospace specified devices are required, please contact the National Semiconductor Sales Office/Distributors for availability and specifications.

Supply Voltage
 Operating Range 4.75V to 26V
 Overvoltage Protection (100 ms) -50V to +60V

Internal Power Dissipation Internally Limited
 Operating Temperature Range -40°C to +125°C
 Maximum Junction Temperature 150°C
 Storage Temperature Range -65°C to +150°C
 Lead Temp. (Soldering, 10 seconds) 230°C

Electrical Characteristics (V_{CC} = 12V, I_{OUT} = 500 mA, T_J = 25°C, V_{ON/OFF} = 2V, unless otherwise specified.)

Parameter	Conditions	Typ	Tested Limits (Note 1)		Design Limits (Note 2)		Units
			Min	Max	Min	Max	
Supply Voltage Operational Survival Transient	100 ms, 1% Duty Cycle		4.75 -15 -50	26 60	6	24	V V _{DC} V
Supply Current V _{ON/OFF} = 0 V _{ON/OFF} = 2V	I _{OUT} = 0 mA I _{OUT} = 250 mA I _{OUT} = 500 mA I _{OUT} = 1A	0.6 6 285 575 1.3		10 350 700 1.5		1.5	mA mA mA A
Input to Output Voltage Drop	I _{OUT} = 500 mA I _{OUT} = 1A	0.5 1.0		0.8			V V
Short Circuit Current	6V ≤ V _{CC} ≤ 24V	1.4	1.0	2.0	.75	3.0	A A
Output Leakage Current	V _{ON/OFF} = 0	0.1				50	μA
ON/OFF Voltage Threshold	6V ≤ V _{CC} ≤ 24V	1.3	0.8	2.0	0.8	2.0	V V
ON/OFF Current		15	10	30			μA
Overvoltage Shutdown		32			26	36	V
Thermal Resistance junction-case case-ambient	θ _{jc} θ _{ca}	3 50					°C/W °C/W
Inductive Clamp Output Voltage	V _{ON/OFF} = 0, I _{OUT} = 100 mA	-60			-120	-45	V
Fault Conditions Output Current							
ON/OFF Floating	Pin 5 Open	0.1				50	μA
Ground Floating	Pin 3 & Pin 4 Open	0.1				50	μA
Reverse Voltage	V _{CC} = -15V	-0.01			-1		mA
Reverse Transient	V _{CC} = -50V	-100					mA
Overvoltage	V _{CC} = +60V	0.01				1	mA
Supply Current	Pin 1 & Pin 2 Short, No load	10				40	mA

Note 1: Guaranteed and 100% production tested.

Note 2: Guaranteed, not necessarily 100% production tested. Not used to calculate outgoing AQL. Limits are for the temperature range of -40°C ≤ T_J ≤ 150°C.

Typical Performance Characteristics

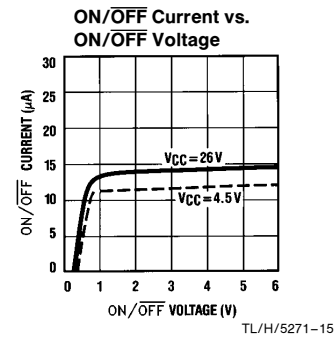
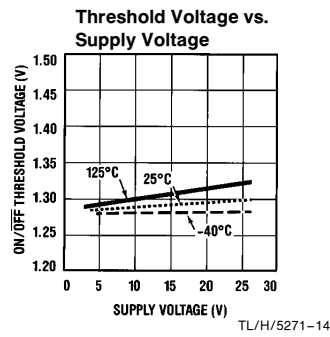
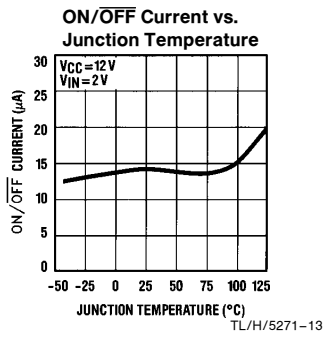
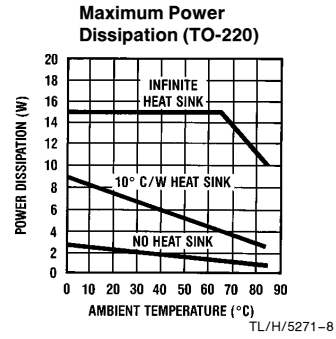
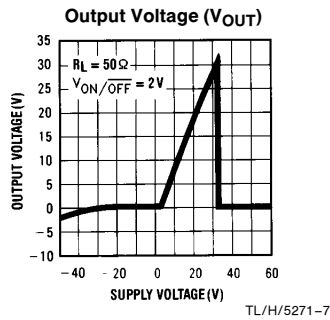
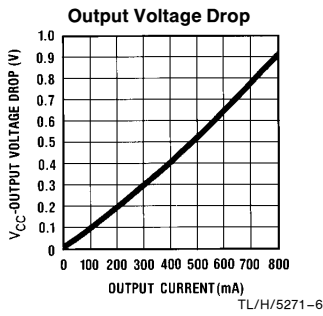
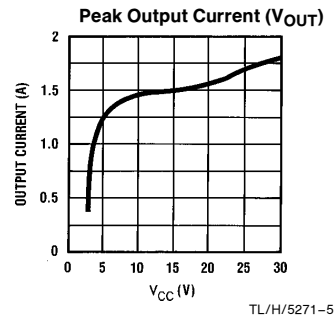
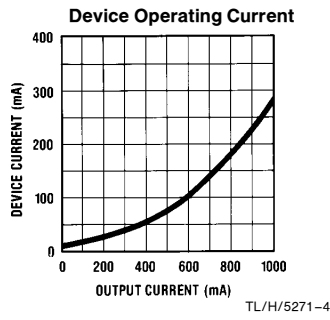
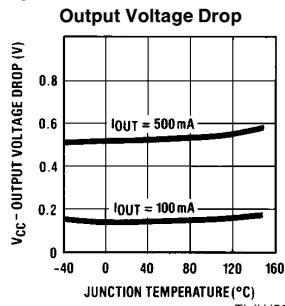

Equivalent Block Diagram

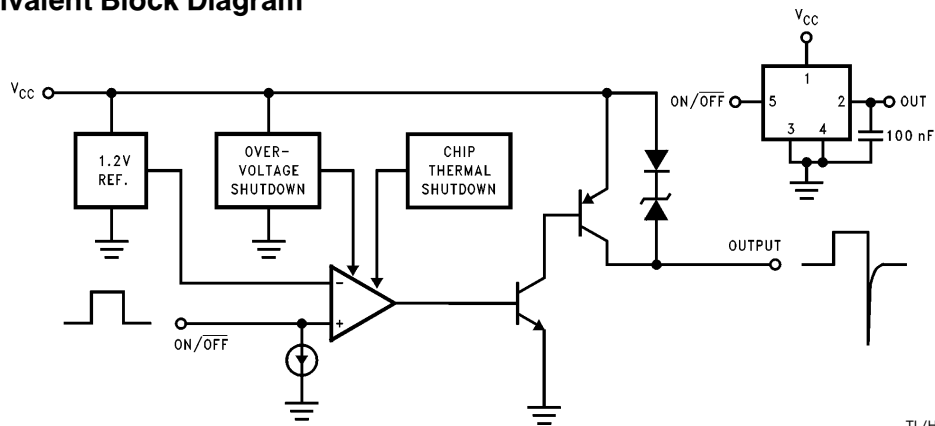

Circuit Schematic

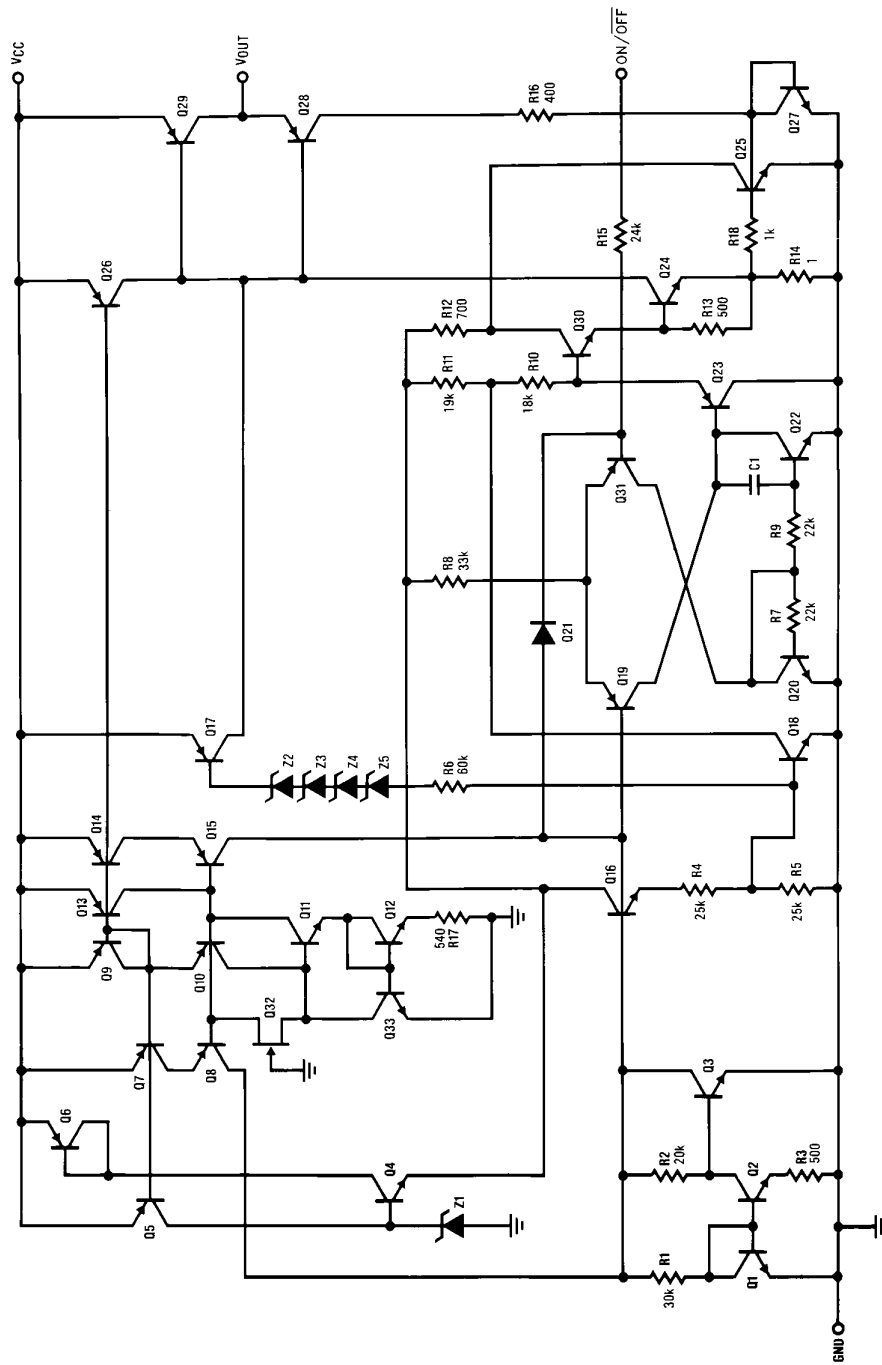

TL/H/5271-9

Application Hints

HIGH CURRENT OUTPUT

The 1 Amp output is fault protected against overvoltage. If the supply voltage rises above approximately 30 volts, the output will automatically shut down. This protects the internal circuitry and enables the IC to survive higher voltage transients than would otherwise be expected. The 1921 will survive transients and DC voltages up to 60 volts on the supply. The output remains off during this time, independent of the state of the input logic voltage. This protects the load. The high current output is also protected against short circuits to either ground or supply voltage. Standard thermal shutdown circuits are employed to protect the 1921 from over heating.

FLYBACK RESPONSE

Since the 1921 is designed to drive inductive as well as any other type of load, inductive kickback can be expected whenever the output changes state from on to off (see waveforms on *Figure 1*). The driver output was left unclamped since it is often desirable in many systems to achieve a very rapid decay in the load current. In applications where this is not true, such as in *Figure 2*, a simple external diode clamp will suffice. In this application, the integrated current in the inductive load is controlled by varying the duty cycle of the input to the driver IC. This technique achieves response characteristics that are desirable for certain automotive transmission solenoids, for example.

For applications requiring a rapid controlled decay in the solenoid current, such as fuel injector drivers, an external zener and diode can be used as in *Figure 3*. The voltage rating of the zener should be such that it breaks down before the output of the LM1921. The minimum output breakdown voltage of the IC output is rated at -57 volts with respect to the supply voltage. Thus, on a 12 volt supply, the

combined zener and diode breakdown should be less than 45 volts.

The LM1921 can be used alone as a simple relay or solenoid driver where a rapid decay of the load current is desired, but the exact rate of decay is not critical to the system. If the output is unclamped as in *Figure 1*, and the load is inductive enough, the negative flyback transient will cause the output of the IC to breakdown and behave similarly to a zener clamp. Relying upon the IC breakdown is practical, and will not damage or degrade the IC in any way. There are two considerations that must be accounted for when the driver is operated in this mode. The IC breakdown voltage is process and lot dependent. Clamp voltages ranging from -60 to -120 volts (with respect to the supply voltage) will be encountered over time on different devices. This is not at all critical in most applications. An important consideration, however, is the additional heat dissipated in the IC as a result. This must be added to normal device dissipation when considering junction temperatures and heat sinking requirements. Worst case for the additional dissipation can be approximated as:

$$\text{Additional } P_D = I^2 \times L \times f \text{ (Watts)}$$

where: I = peak solenoid current (Amps)

L = solenoid inductance (Henries)

f = maximum frequency input signal (Hz)

For solenoids where the inductance is less than ten millihenries, the additional power dissipation can be ignored.

Overshoot, undershoot, and ringing can occur on certain loads. The simple solution is to lower the Q of the load by the addition of a resistor in parallel or series with the load. A value that draws one tenth of the current or DC voltage of the load is usually sufficient.

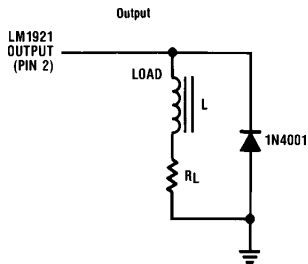

FIGURE 2. Diode Clamp

TL/H/5271-10

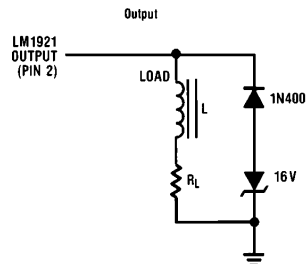

FIGURE 3

Zener clamp for rapid controlled current decay

TL/H/5271-11

