

LM10 Operational Amplifier and Voltage Reference

General Description

The LM10 series are monolithic linear ICs consisting of a precision reference, an adjustable reference buffer and an independent, high quality op amp.

The unit can operate from a total supply voltage as low as 1.1V or as high as 40V, drawing only 270 μ A. A complementary output stage swings within 15 mV of the supply terminals or will deliver ± 20 mA output current with ± 0.4 V saturation. Reference output can be as low as 200 mV. Some other characteristics of the LM10 are

■ input offset voltage	2.0 mV (max)
■ input offset current	0.7 nA (max)
■ input bias current	20 nA (max)
■ reference regulation	0.1% (max)
■ offset voltage drift	2 μ V/ $^{\circ}$ C
■ reference drift	0.002%/ $^{\circ}$ C

The circuit is recommended for portable equipment and is completely specified for operation from a single power cell. In contrast, high output-drive capability, both voltage and current, along with thermal overload protection, suggest it in demanding general-purpose applications.

The device is capable of operating in a floating mode, independent of fixed supplies. It can function as a remote comparator, signal conditioner, SCR controller or transmitter for analog signals, delivering the processed signal on the same line used to supply power. It is also suited for operation in a wide range of voltage- and current-regulator applications, from low voltages to several hundred volts, providing greater precision than existing ICs.

This series is available in the three standard temperature ranges, with the commercial part having relaxed limits. In addition, a low-voltage specification (suffix "L") is available in the limited temperature ranges at a cost savings.

Connection and Functional Diagrams

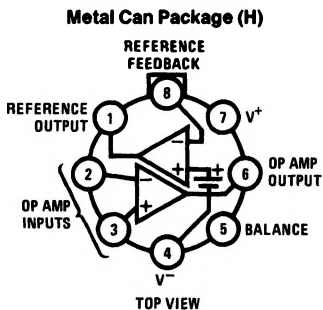

TL/H/5652-1

Order Number LM10BH, LM10CH,
LM10CLH or LM10H/883
available per SMA # 5962-8760401
See NS Package Number H08A

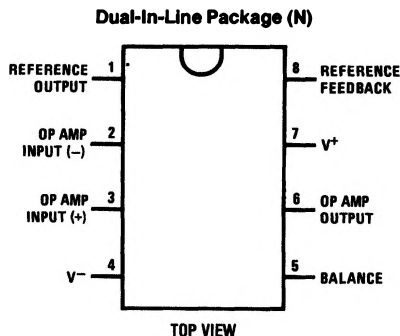

TL/H/5652-15

Order Number LM10CN or LM10CLN
See NS Package Number N08E

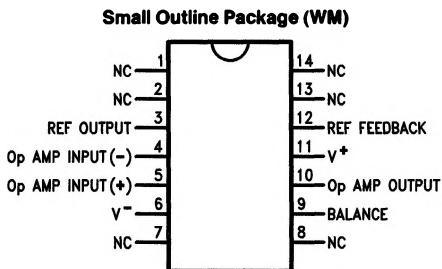

TL/H/5652-17

Order Number LM10CWM
See NS Package Number M14B

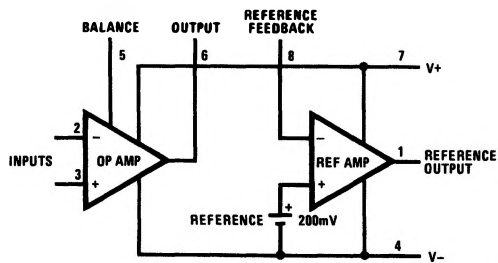

TL/H/5652-16

Absolute Maximum Ratings

If Military/Aerospace specified devices are required, please contact the National Semiconductor Sales Office/Distributors for availability and specifications. (Note 7)

	LM10/LM10B/ LM10BL/	
	LM10C	LM10CL
Total Supply Voltage	45V	7V
Differential Input Voltage (note 1)	±40V	±7V
Power Dissipation (note 2)	internally limited	
Output Short-circuit Duration (note 3)	continuous	
Storage-Temp. Range	-55°C to +150°C	
Lead Temp. (Soldering, 10 seconds)		
Metal Can	300°C	
Lead Temp. (Soldering, 10 seconds) DIP	260°C	
Vapor Phase (60 seconds)	215°C	
Infrared (15 seconds)	220°C	

See AN-450 "Surface Mounting Methods and Their Effect on Product Reliability" for other methods of soldering surface mount devices.

ESD rating is to be determined.

Maximum Junction Temperature	
LM10	150°C
LM10B	100°C
LM10C	85°C

Operating Ratings

Package Thermal Resistance	
θ_{JA}	
H Package	150°C/W
N Package	87°C/W
WM Package	90°C/W
θ_{JC}	
H Package	45°C/W

Electrical Characteristics

$T_J = 25^\circ\text{C}$, $T_{MIN} \leq T_J \leq T_{MAX}$ (note 4) (Boldface type refers to limits over temperature range)

Parameter	Conditions	LM10/LM10B			LM10C			Units
		Min	Typ	Max	Min	Typ	Max	
Input offset voltage			0.3	2.0 3.0		0.5	4.0 5.0	mV mV
Input offset current (note 5)			0.25	0.7 1.5		0.4	2.0 3.0	nA nA
Input bias current			10	20 30		12	30 40	nA nA
Input resistance		250 150	500		150 115	400		k Ω k Ω
Large signal voltage gain	$V_S = \pm 20\text{V}$, $I_{OUT} = 0$	120	400		80	400		V/mV
	$V_{OUT} = \pm 19.95\text{V}$	80			50			V/mV
	$V_S = \pm 20\text{V}$, $V_{OUT} = \pm 19.4\text{V}$	50	130		25	130		V/mV
	$I_{OUT} = \pm 20\text{ mA}$ ($\pm 15\text{ mA}$)	20			15			V/mV
	$V_S = \pm 0.6\text{V}$ (0.65V), $I_{OUT} = \pm 2\text{ mA}$	1.5	3.0		1.0	3.0		V/mV
	$V_{OUT} = \pm 0.4\text{V}$ ($\pm 0.3\text{V}$), $V_{CM} = -0.4\text{V}$	0.5			0.75			V/mV
Shunt gain (note 6)	1.2V (1.3V) $\leq V_{OUT} \leq 40\text{V}$, $R_L = 1.1\text{ k}\Omega$	14	33		10	33		V/mV
	$0.1\text{ mA} \leq I_{OUT} \leq 5\text{ mA}$	6			6			V/mV
	$1.5\text{V} \leq V^+ \leq 40\text{V}$, $R_L = 250\Omega$	8	25		6	25		V/mV
	$0.1\text{ mA} \leq I_{OUT} \leq 20\text{ mA}$	4			4			V/mV
Common-mode rejection	$-20\text{V} \leq V_{CM} \leq 19.15\text{V}$ (19V) $V_S = \pm 20\text{V}$	93 87	102		90 87	102		dB dB
	$-0.2\text{V} \geq V^- \geq -39\text{V}$ $V^+ = 1.0\text{V}$ (1.1V)	90 84	96		87 84	96		dB dB
Supply-voltage rejection	1.0V (1.1V) $\leq V^+ \leq 39.8\text{V}$	96 90	106		93 90	106		dB dB
	$V^- = -0.2\text{V}$							dB
								dB
Offset voltage drift			2.0			5.0		$\mu\text{V}/^\circ\text{C}$
Offset current drift			2.0			5.0		$\text{pA}/^\circ\text{C}$
Bias current drift	$T_C < 100^\circ\text{C}$		60			90		$\text{pA}/^\circ\text{C}$
Line regulation	1.2V (1.3V) $\leq V_S \leq 40\text{V}$		0.001	0.003		0.001	0.008	%/V
	$0 \leq I_{REF} \leq 1.0\text{ mA}$, $V_{REF} = 200\text{ mV}$			0.006			0.01	%/V
Load regulation	$0 \leq I_{REF} \leq 1.0\text{ mA}$		0.01	0.1		0.01	0.15	%
	$V^+ - V_{REF} \geq 1.0\text{V}$ (1.1V)			0.15			0.2	%

Electrical Characteristics

$T_J = 25^\circ\text{C}$, $T_{\text{MIN}} \leq T_J \leq T_{\text{MAX}}$, (note 4) (Boldface type refers to limits over temperature range) (Continued)

Parameter	Conditions	LM10/LM10B			LM10C			Units
		Min	Typ	Max	Min	Typ	Max	
Amplifier gain	$0.2\text{V} \leq V_{\text{REF}} \leq 35\text{V}$	50 23	75		25 15	70		V/mV V/mV
Feedback sense voltage		195 194	200	205 206	190 189	200	210 211	mV mV
Feedback current			20	50 65		22	75 90	nA nA
Reference drift			0.002			0.003		%/°C
Supply current			270	400 500		300	500 570	μA μA
Supply current change	$1.2\text{V} (\mathbf{1.3V}) \leq V_S \leq 40\text{V}$		15	75		15	75	μA

Parameter	Conditions	LM10BL			LM10CL			Units
		Min	Typ	Max	Min	Typ	Max	
Input offset voltage			0.3	2.0 3.0		0.5	4.0 5.0	mV mV
Input offset current (note 5)			0.1	0.7 1.5		0.2	2.0 3.0	nA nA
Input bias current			10	20 30		12	30 40	nA nA
Input resistance		250 150	500		150 115	400		k Ω k Ω
Large signal voltage gain	$V_S = \pm 3.25\text{V}$, $I_{\text{OUT}} = 0$	60	300		40	300		V/mV
	$V_{\text{OUT}} = \pm 3.2\text{V}$	40			25			V/mV
	$V_S = \pm 3.25\text{V}$, $I_{\text{OUT}} = 10\text{ mA}$	10	25		5	25		V/mV
	$V_{\text{OUT}} = \pm 2.75\text{ V}$	4			3			V/mV
	$V_S = \pm 0.6\text{V} (\mathbf{0.65V})$, $I_{\text{OUT}} = \pm 2\text{ mA}$	1.5	3.0		1.0	3.0		V/mV
	$V_{\text{OUT}} = \pm 0.4\text{V} (\pm \mathbf{0.3V})$, $V_{\text{CM}} = -0.4\text{V}$	0.5			0.75			V/mV
Shunt gain (note 6)	$1.5\text{V} \leq V^+ \leq 6.5\text{V}$, $R_L = 500\Omega$	8	30		6	30		V/mV
	$0.1\text{ mA} \leq I_{\text{OUT}} \leq 10\text{ mA}$	4			4			V/mV
Common-mode rejection	$-3.25\text{V} \leq V_{\text{CM}} \leq 2.4\text{V} (\mathbf{2.25V})$	89	102		80	102		dB
	$V_S = \pm 3.25\text{V}$	83			74			dB
Supply-voltage rejection	$-0.2\text{V} \geq V^- \geq -5.4\text{V}$	86	96		80	96		dB
	$V^+ = 1.0\text{V} (\mathbf{1.2V})$	80			74			dB
	$1.0\text{V} (\mathbf{1.1V}) \leq V^+ \leq 6.3\text{V}$	94	106		80	106		dB
	$V^- = 0.2\text{V}$	88			74			dB
Offset voltage drift			2.0			5.0		$\mu\text{V}/^\circ\text{C}$
Offset current drift			2.0			5.0		$\text{pA}/^\circ\text{C}$
Bias current drift			60			90		$\text{pA}/^\circ\text{C}$
Line regulation	$1.2\text{V} (\mathbf{1.3V}) \leq V_S \leq 6.5\text{V}$		0.001	0.01		0.001	0.02	%/V
	$0 \leq I_{\text{REF}} \leq 0.5\text{ mA}$, $V_{\text{REF}} = 200\text{ mV}$			0.02			0.03	%/V
Load regulation	$0 \leq I_{\text{REF}} \leq 0.5\text{ mA}$		0.01	0.1		0.01	0.15	%
	$V^+ - V_{\text{REF}} \geq 1.0\text{V} (\mathbf{1.1V})$			0.15			0.2	%
Amplifier gain	$0.2\text{V} \leq V_{\text{REF}} \leq 5.5\text{V}$	30	70		20	70		V/mV
		20			15			V/mV

Electrical Characteristics

$T_J = 25^\circ\text{C}$, $T_{\text{MIN}} \leq T_J \leq T_{\text{MAX}}$, (note 4) (**Boldface type refers to limits over temperature range**) (Continued)

Parameter	Conditions	LM10BL			LM10CL			Units
		Min	Typ	Max	Min	Typ	Max	
Feedback sense voltage		195	200	205	190	200	210	mV
		194		206	189		211	mV
Feedback current			20	50		22	75	nA
				65			90	nA
Reference drift			0.002			0.003	%/°C	
Supply current			260	400		280	500	μA
				500			570	μA

Note 1: The input voltage can exceed the supply voltages provided that the voltage from the input to any other terminal does not exceed the maximum differential input voltage and excess dissipation is accounted for when $V_{\text{IN}} < V^-$.

Note 2: The maximum, operating-junction temperature is 150°C for the LM10, 100°C for the LM10B(L) and 85°C for the LM10C(L). At elevated temperatures, devices must be derated based on package thermal resistance.

Note 3: Internal thermal limiting prevents excessive heating that could result in sudden failure, but the IC can be subjected to accelerated stress with a shorted output and worst-case conditions.

Note 4: These specifications apply for $V^- \leq V_{\text{CM}} \leq V^+ - 0.85\text{V}$ (**1.0V**), 1.2V (**1.3V**) $< V_S \leq V_{\text{MAX}}$, $V_{\text{REF}} = 0.2\text{V}$ and $0 \leq I_{\text{REF}} \leq 1.0\text{ mA}$, unless otherwise specified: $V_{\text{MAX}} = 40\text{V}$ for the standard part and 6.5V for the low voltage part. Normal typeface indicates 25°C limits. **Boldface type indicates limits and altered test conditions for full-temperature-range operation**; this is -55°C to 125°C for the LM10, -25°C to 85°C for the LM10B(L) and 0°C to 70°C for the LM10C(L). The specifications do not include the effects of thermal gradients ($\tau_1 = 20\text{ ms}$), die heating ($\tau_2 = 0.2\text{ s}$) or package heating. Gradient effects are small and tend to offset the electrical error (see curves).

Note 5: For $T_J > 90^\circ\text{C}$, I_{OS} may exceed 1.5 nA for $V_{\text{CM}} = V^-$. With $T_J = 125^\circ\text{C}$ and $V^- \leq V_{\text{CM}} \leq V^- + 0.1\text{V}$, $I_{\text{OS}} \leq 5\text{ nA}$.

Note 6: This defines operation in floating applications such as the bootstrapped regulator or two-wire transmitter. Output is connected to the V^+ terminal of the IC and input common mode is referred to V^- (see typical applications). Effect of larger output-voltage swings with higher load resistance can be accounted for by adding the positive-supply rejection error.

Note 7: Refer to RETS10X for LM10H military specifications.

Definition of Terms

Input offset voltage: That voltage which must be applied between the input terminals to bias the unloaded output in the linear region.

Input offset current: The difference in the currents at the input terminals when the unloaded output is in the linear region.

Input bias current: The absolute value of the average of the two input currents.

Input resistance: The ratio of the change in input voltage to the change in input current on either input with the other grounded.

Large signal voltage gain: The ratio of the specified output voltage swing to the change in differential input voltage required to produce it.

Shunt gain: The ratio of the specified output voltage swing to the change in differential input voltage required to produce it with the output tied to the V^+ terminal of the IC. The load and power source are connected between the V^+ and V^- terminals, and input common-mode is referred to the V^- terminal.

Common-mode rejection: The ratio of the input voltage range to the change in offset voltage between the extremes.

Supply-voltage rejection: The ratio of the specified supply-voltage change to the change in offset voltage between the extremes.

Line regulation: The average change in reference output voltage over the specified supply voltage range.

Load regulation: The change in reference output voltage from no load to that load specified.

Feedback sense voltage: The voltage, referred to V^- , on the reference feedback terminal while operating in regulation.

Reference amplifier gain: The ratio of the specified reference output change to the change in feedback sense voltage required to produce it.

Feedback current: The absolute value of the current at the feedback terminal when operating in regulation.

Supply current: The current required from the power source to operate the amplifier and reference with their outputs unloaded and operating in the linear range.

Typical Performance Characteristics (Op Amp)

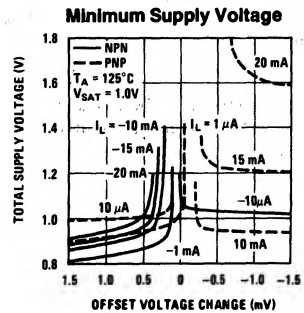
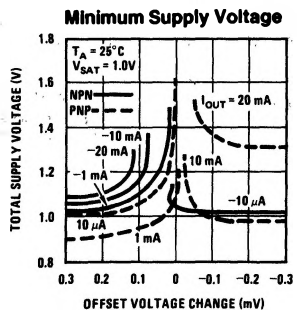
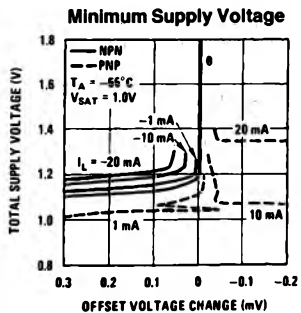
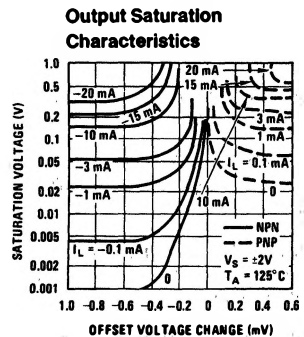
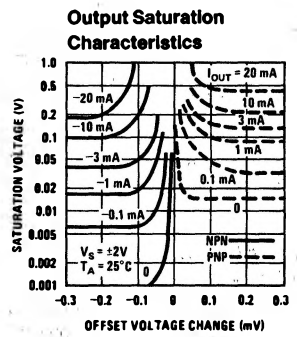
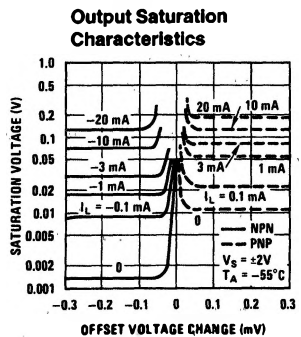
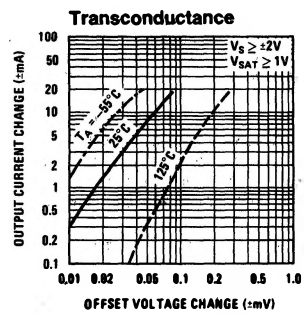
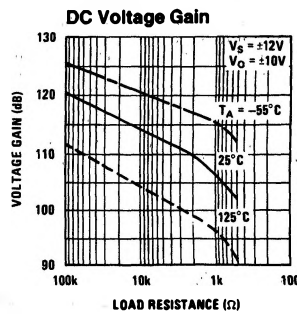
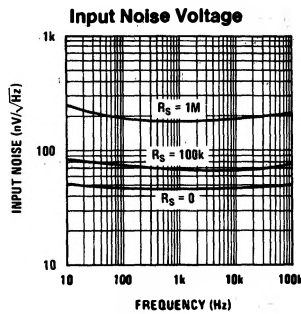
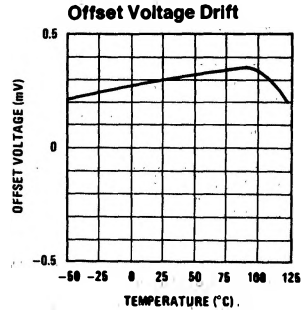
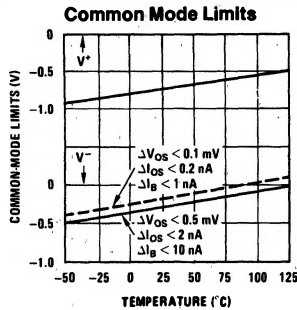
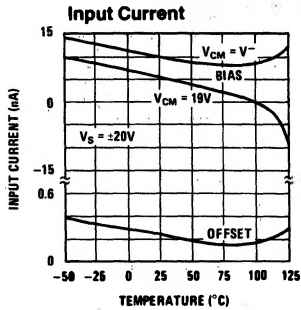

Typical Performance Characteristics (Op Amp) (Continued)

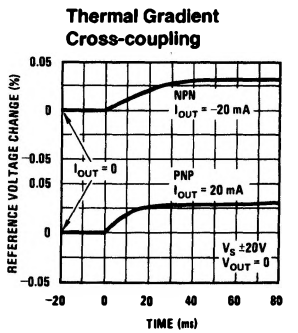
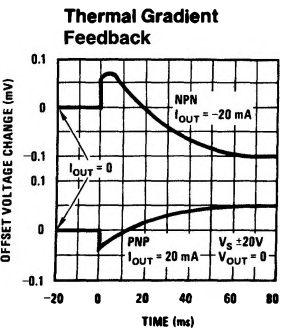
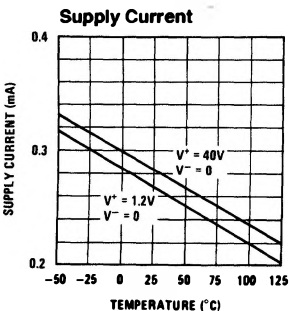
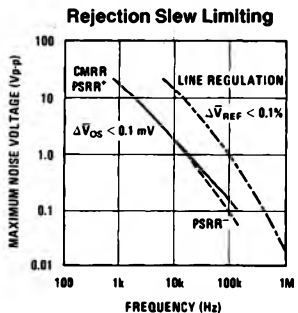
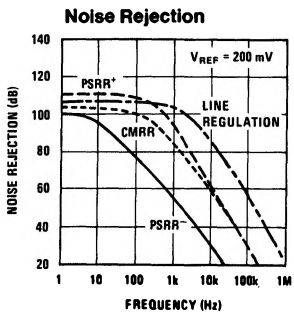
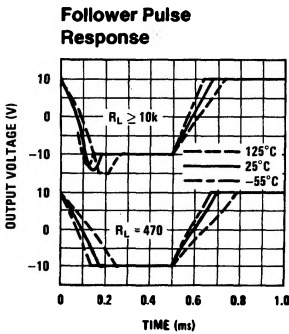
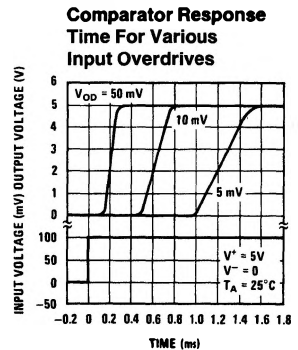
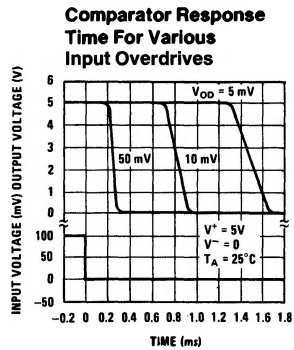
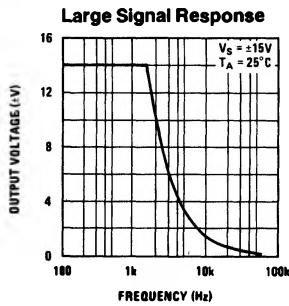
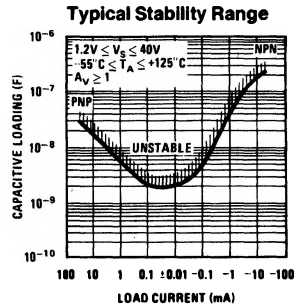
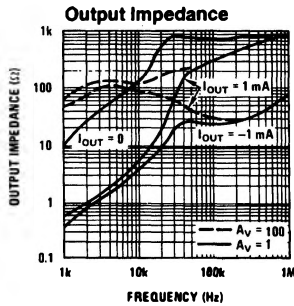
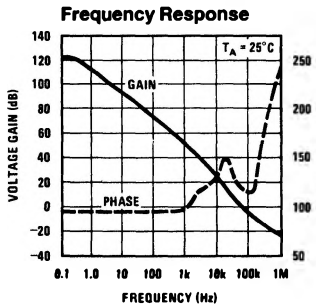

Typical Performance Characteristics (Op Amp) (Continued)

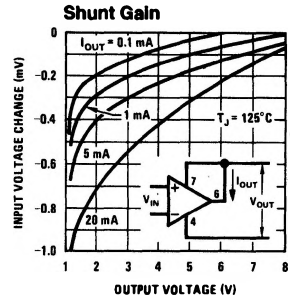
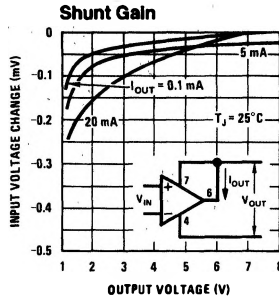
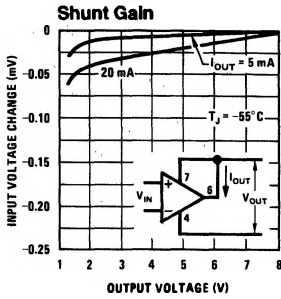

TL/H/5652-4

Typical Performance Characteristics (Reference)

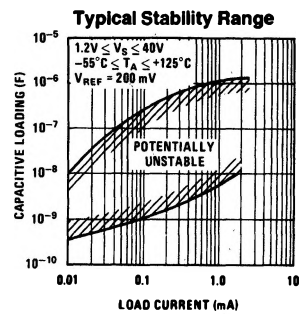
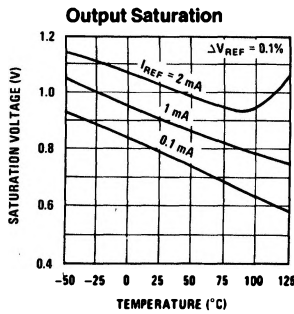
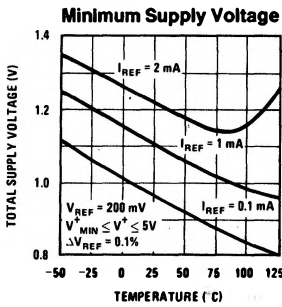
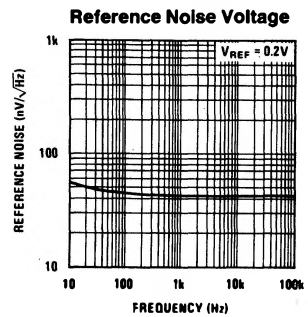
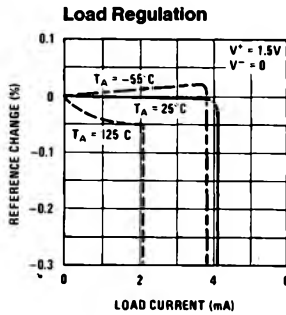
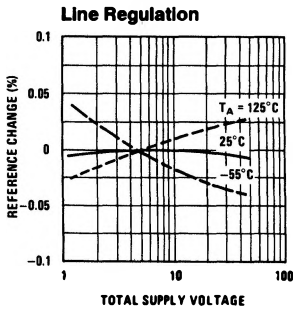

TL/H/5652-5

Typical Applications^{††} (Pin numbers are for devices in 8-pin packages)

Op Amp Offset Adjustment

Standard

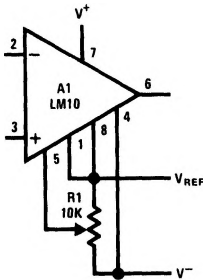

Limited Range

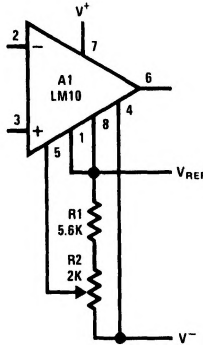

Limited Range With Boosted Reference

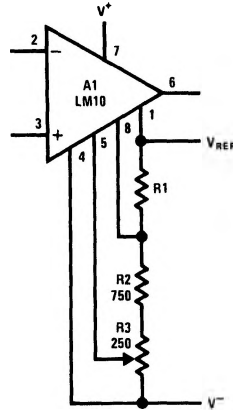

Positive Regulators[†]

Low Voltage

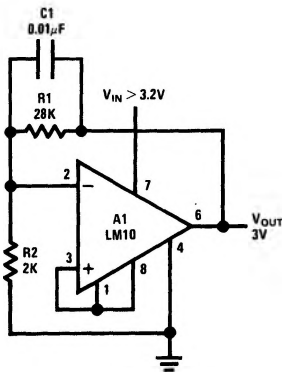

Best Regulation

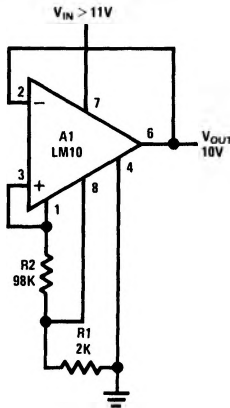

Zero Output

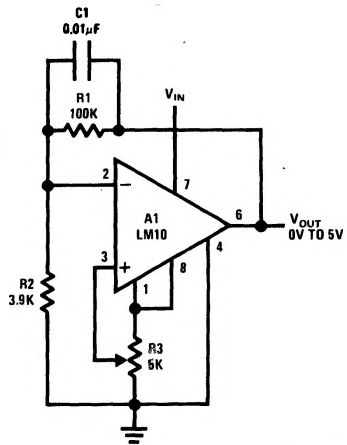

[†]Use only electrolytic output capacitors.

^{††}Circuit descriptions available in application note AN-211.

Typical Applications^{††} (Pin numbers are for devices in 8-pin packages) (Continued)

Current Regulator

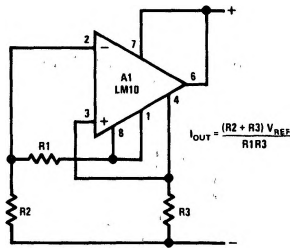

Shunt Regulator

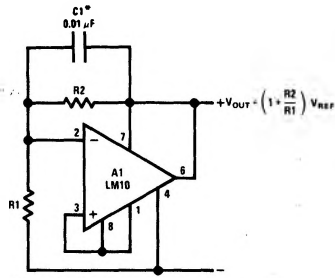

*Required For Capacitive Loading

Negative Regulator

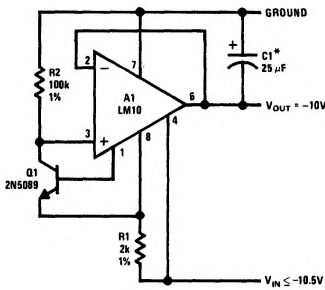

*Electrolytic

Precision Regulator

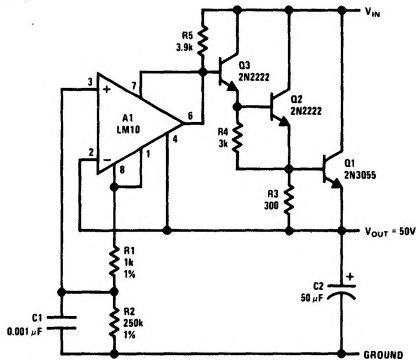

Laboratory Power Supply

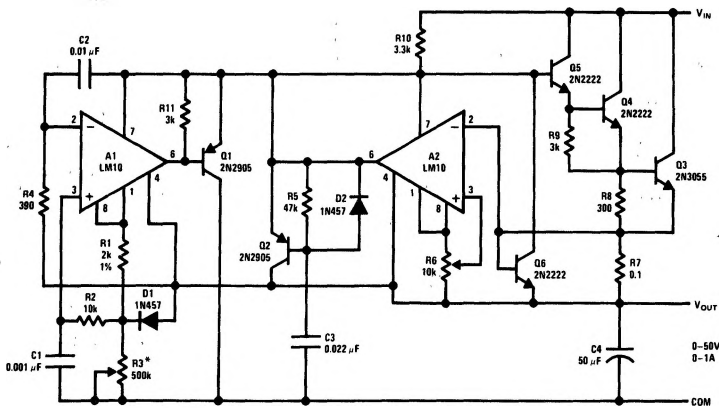

$V_{OUT} = 10^{-4} R3$

^{††}Circuit descriptions available in application note AN-211.

Typical Applications †† (Pin numbers are for devices in 8-pin packages) (Continued)
Transmitter for Bridge Sensor

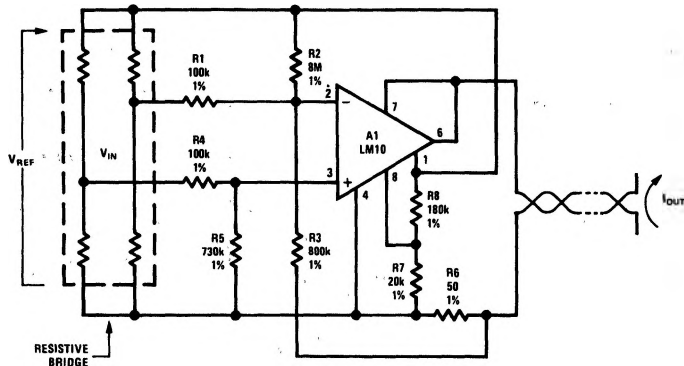

Precision Thermocouple Transmitter

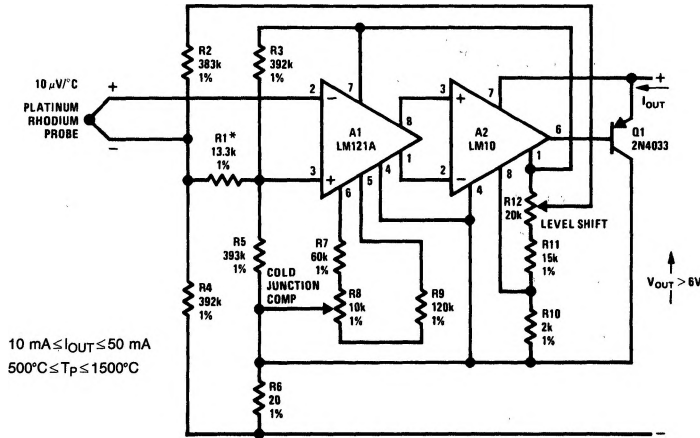

*Gain Trim

Resistance Thermometer Transmitter

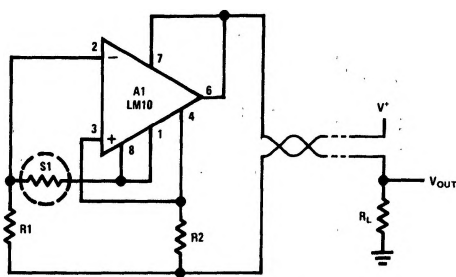

Optical Pyrometer

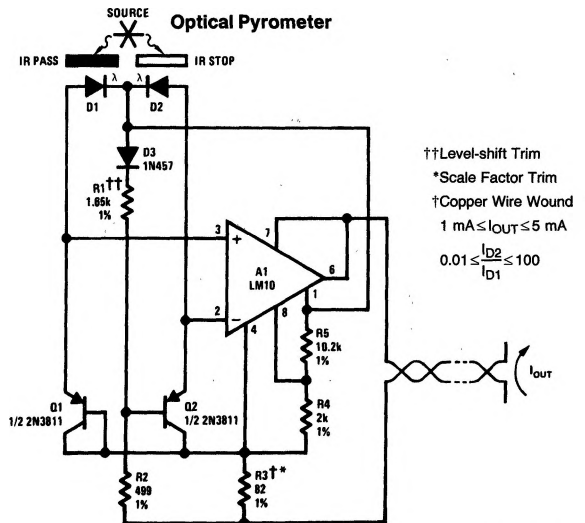

††Circuit descriptions available in application note AN-211.

Typical Applications †† (Pin numbers are for devices in 8-pin packages) (Continued)

Thermocouple Transmitter

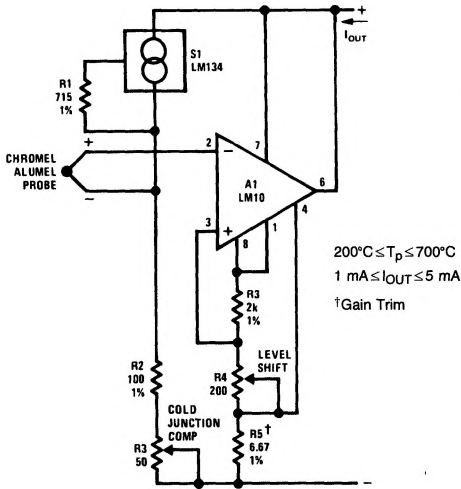

Logarithmic Light Sensor

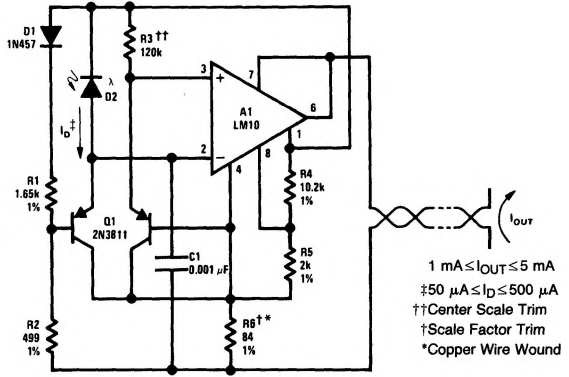

Battery-level Indicator

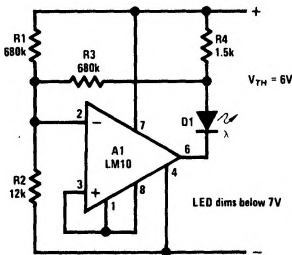

Battery-threshold Indicator

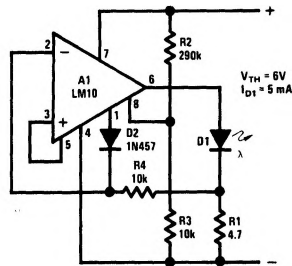

Single-cell Voltage Monitor

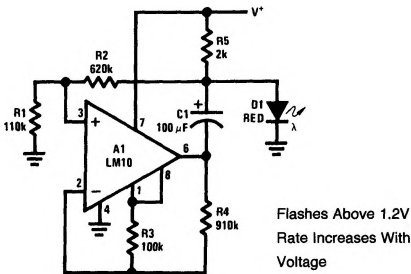

Double-ended Voltage Monitor

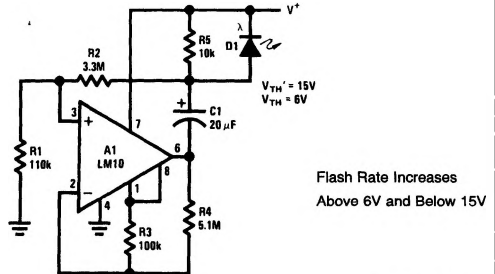

††Circuit descriptions available in application note AN-211.

Typical Applications †† (Pin numbers are for devices in 8-pin packages) (Continued)

Isolated Voltage Sensor

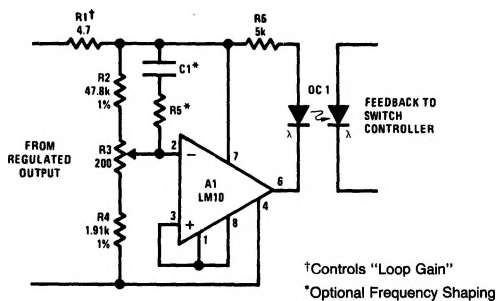

Light-level Controller

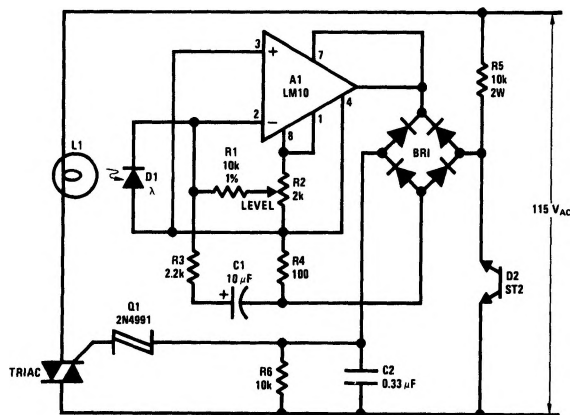

TL/H/5652-12

††Circuit descriptions available in application note AN-211.

Application Hints

With heavy amplifier loading to V^- , resistance drops in the V^- lead can adversely affect reference regulation. Lead resistance can approach 1Ω . Therefore, the common to the reference circuitry should be connected as close as possible to the package.

Operational Amplifier Schematic (Pin numbers are for 8-pin packages)

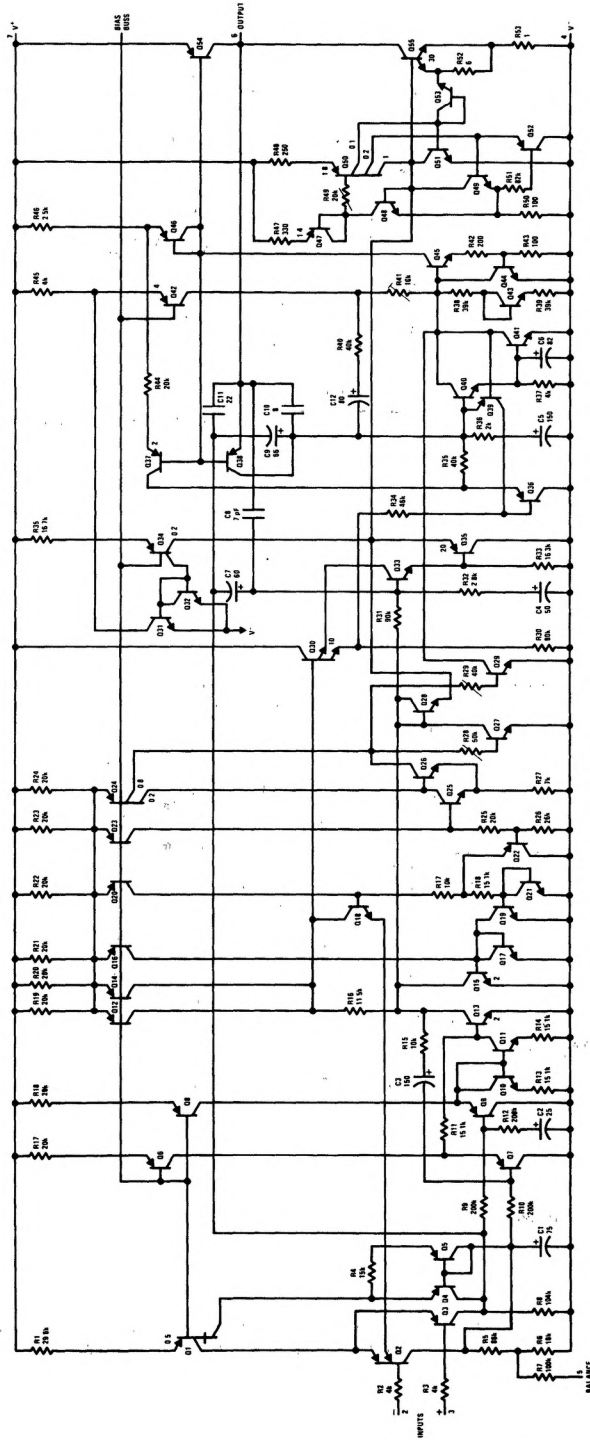

TL/H/5652-13

Reference and Internal Regulator (Pin numbers are for 8-pin packages)

TL/H/5652-14

LM10

