

LL4148

Small Signal Diode

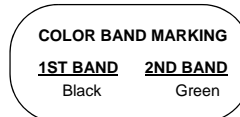

SOD80



The 1st Band indicates the cathode band

Absolute Maximum Ratings * $T_a = 25^\circ\text{C}$ unless otherwise noted

Symbol	Parameter	Value	Units
V_{RRM}	Maximum Repetitive Reverse Voltage	100	V
$I_{F(AV)}$	Average Rectified Forward Current	200	mA
I_f	Recurrent Peak Forward Current	500	mA
I_{FSM}	Non-repetitive Peak Forward Surge Current Pulse Width = 1.0 second Pulse Width = 1.0 microsecond	1.0	A
		2.0	A
T_{STG}	Storage Temperature Range	-65 to +200	$^\circ\text{C}$
T_J	Operating Junction Temperature Range	-55 to +175	$^\circ\text{C}$

* These ratings are limiting values above which the serviceability of the diode may be impaired.

Notes:

- 1) These ratings are based on a maximum junction temperature of 200degrees C.
- 2) These are steady state limits. The factory should be consulted on applications involving pulsed or low duty cycle operations.

Thermal Characteristics

Symbol	Parameter	Value	Units
P_D	Power Dissipation	500	mW
$R_{\theta JA}$	Thermal Resistance, Junction to Ambient	300	$^\circ\text{C}/\text{W}$

Note: Jeduc Standard 51-3 method (PCB Board size 76*114*0.6Tmm3)

Electrical Characteristics $T_a = 25^\circ\text{C}$ unless otherwise noted.

Symbol	Parameter	Conditions	Min.	Max.	Units
V_R	Breakdown Voltage	$I_R = 100\mu\text{A}$	100		V
		$I_R = 5.0\mu\text{A}$	75		V
V_F	Forward Voltage	$I_F = 10\text{mA}$		1.0	V
I_R	Reverse Leakage	$V_R = 20\text{V}$		25	nA
		$V_R = 20\text{V}, T_A = 150^\circ\text{C}$		50	μA
C_T	Total Capacitance	$V_R = 0, f = 1.0\text{MHz}$		4.0	pF
t_{rr}	Reverse Recovery Time	$I_F = 10\text{mA}, V_R = 6.0\text{V} (60\text{mA}),$ $I_{rr} = 1.0\text{mA}, R_L = 100\Omega$		4.0	ns

Package Marking and Ordering Information

Device Marking	Device	Package	Reel Size	Tape Width	Quantity
Color Band Marking	LL4148	SOD80	7"	8mm	2,500

Typical Performance Characteristics

Figure 1. Reverse Voltage vs Reverse Current
BV - 1.0 to 100 μ A

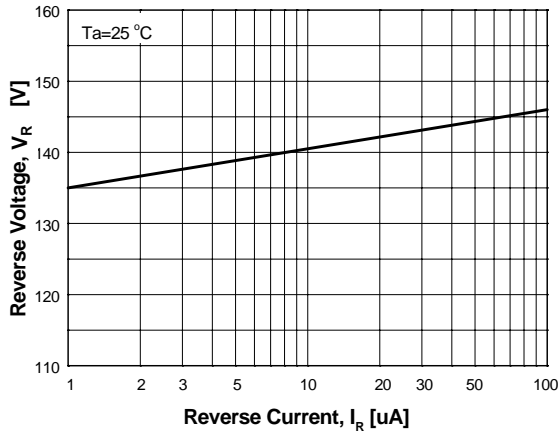

Figure 2. Reverse Voltage vs Reverse Current
I_R - 10 to 100V

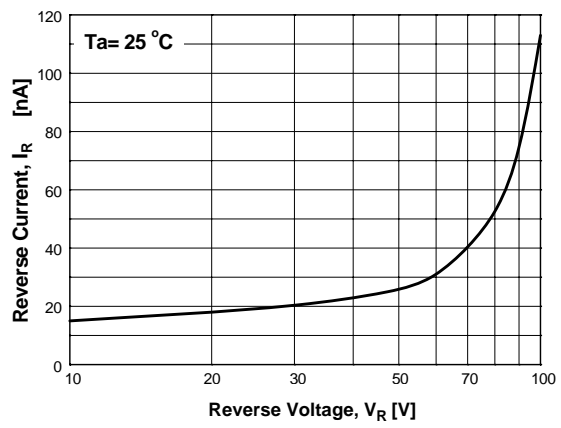

Figure 3. Forward Voltage vs Forward Current
V_F - 1 to 100 μ A

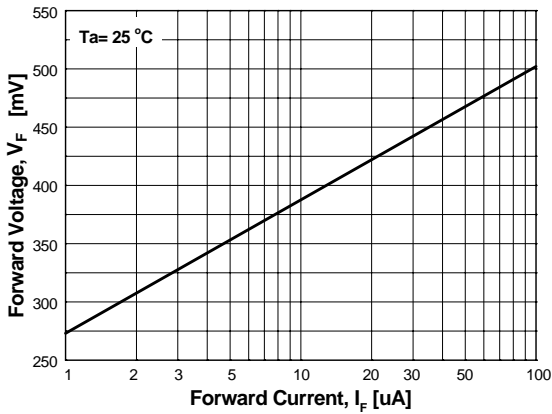

Figure 4. Forward Voltage vs Forward Current
V_F - 0.1 to 10mA

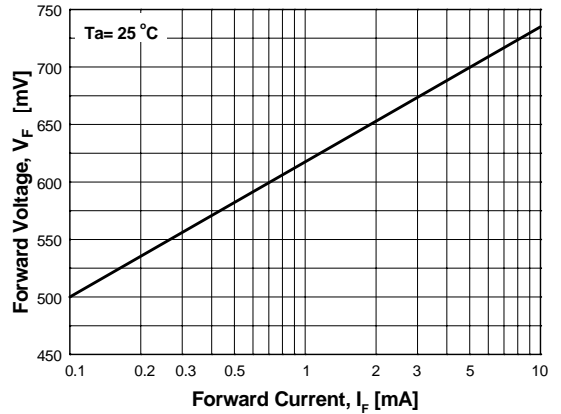

Figure 5. Forward Voltage vs Forward Current
V_F - 10 to 800mA

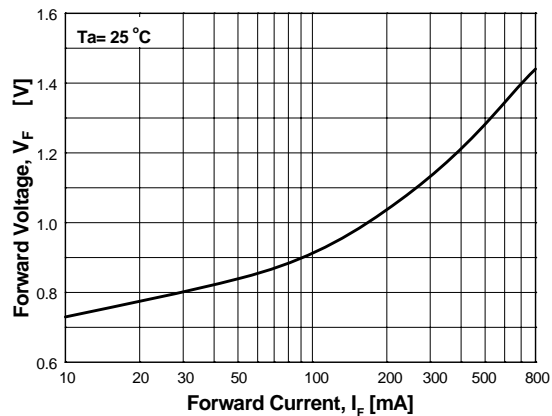
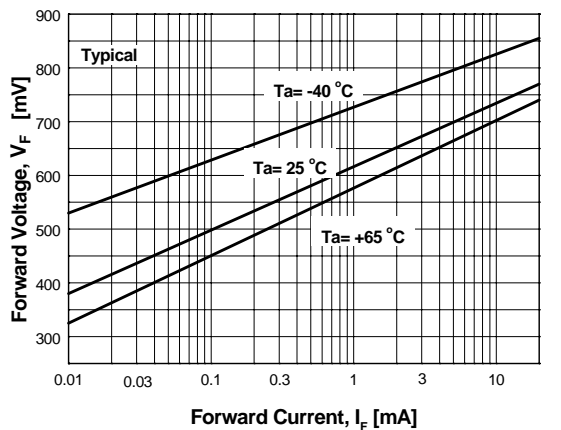

Figure 6. Forward Voltage vs Ambient Temperature
V_F - 0.01 - 20mA (-40 to +65 Deg C)



Typical Performance Characteristics (Continued)

Figure 7. Total Capacitance

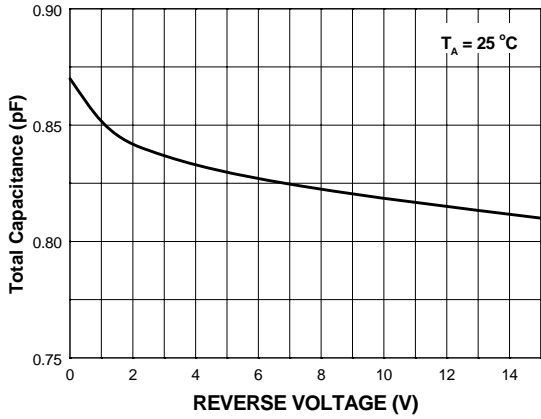

Figure 8. Reverse Recovery Time vs Reverse Recovery Current

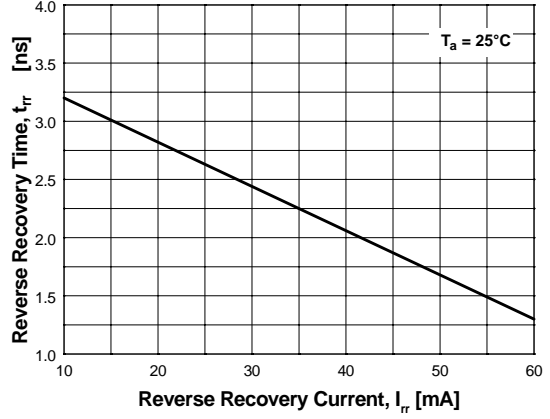

Figure 9. Average Rectified Current ($I_{F(AV)}$) versus Ambient Temperature (T_A)

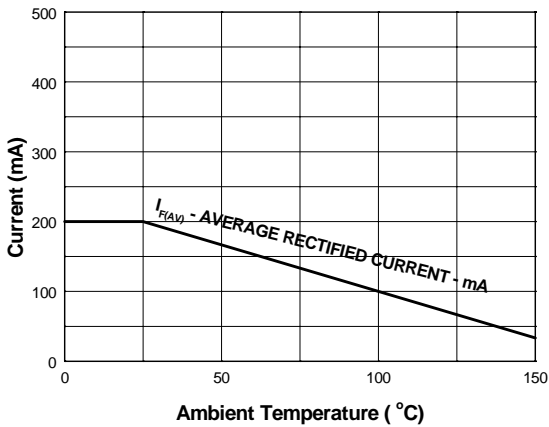
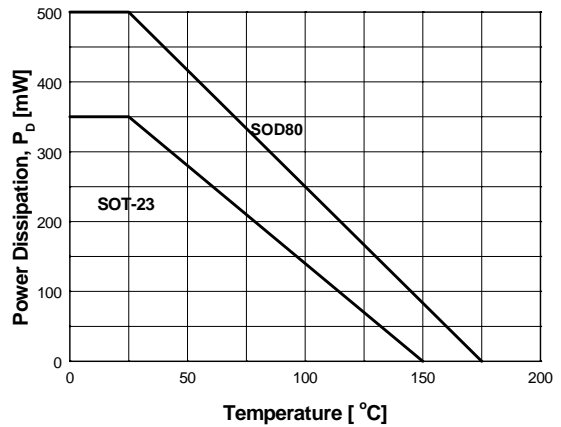
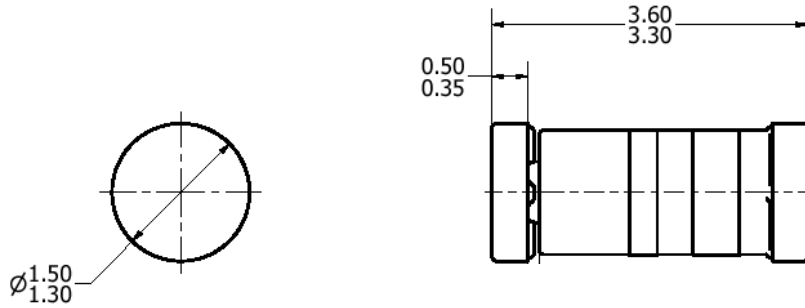

Figure 10. Power Derating Curve



Physical Dimensions

SOD80



NOTE/s:





- 1) THIS PACKAGE CONFORMS TO JEDEC DO-213D, VARIATION AC, DATED 9/1988.
- 2) ALL DIMENSIONS ARE IN MILLIMETERS.

Dimensions in Millimeters



TRADEMARKS

The following includes registered and unregistered trademarks and service marks, owned by Fairchild Semiconductor and/or its global subsidiaries, and is not intended to be an exhaustive list of all such trademarks.

AccuPower™	FPS™	Power-SPM™	The Power Franchise®
Auto-SPM™	F-PFS™	PowerTrench®	The Right Technology for Your Success™
AX-CAP™*	FRFET®	PowerXS™	the
BitSiC®	Global Power Resource™	Programmable Active Droop™	power
Build it Now™	Green FPS™	QFET®	franchise
CorePLUS™	Green FPS™ e-Series™	QS™	TinyBoost™
CorePOWER™	Gmax™	Quiet Series™	TinyBuck™
CROSSVOLT™	GTO™	RapidConfigure™	TinyCalc™
CTL™	IntelliMAX™	 ™	TinyLogic®
Current Transfer Logic™	ISOPANAR™	Saving our world, 1mW/W/kW at a time™	TINYOPTO™
DEUXPEED®	MegaBuck™	SignalWise™	TinyPower™
Dual Cool™	MICROCOUPLER™	SmartMax™	TinyPWM™
EcoSPARK®	MicroFET™	SMART START™	TinyWire™
EfficientMax™	MicroPak™	SPM®	TranSiC®
ESBC™	MicroPak2™	STEALTH™	TriFault Detect™
 ™	MillerDrive™	SuperFET®	TRUECURRENT®*
Fairchild®	MotionMax™	SuperSOT™-3	µSerDes™
Fairchild Semiconductor®	Motion-SPM™	SuperSOT™-6	 ™
FACT Quiet Series™	mWSaver™	SuperSOT™-8	UHC®
FACT®	OptoHi™	SupreMOS®	Ultra FRFET™
FAST®	OPTOLOGIC®	SyncFET™	UniFET™
FastvCore™	OPTOPLANAR®	Sync-Lock™	VCX™
FETBench™	 ™	 ™	VisualMax™
FlashWriter®*	PDP SPM™		XS™

* Trademarks of System General Corporation, used under license by Fairchild Semiconductor.

DISCLAIMER

FAIRCHILD SEMICONDUCTOR RESERVES THE RIGHT TO MAKE CHANGES WITHOUT FURTHER NOTICE TO ANY PRODUCTS HEREIN TO IMPROVE RELIABILITY, FUNCTION, OR DESIGN. FAIRCHILD DOES NOT ASSUME ANY LIABILITY ARISING OUT OF THE APPLICATION OR USE OF ANY PRODUCT OR CIRCUIT DESCRIBED HEREIN; NEITHER DOES IT CONVEY ANY LICENSE UNDER ITS PATENT RIGHTS, NOR THE RIGHTS OF OTHERS. THESE SPECIFICATIONS DO NOT EXPAND THE TERMS OF FAIRCHILD'S WORLDWIDE TERMS AND CONDITIONS, SPECIFICALLY THE WARRANTY THEREIN, WHICH COVERS THESE PRODUCTS.

LIFE SUPPORT POLICY

FAIRCHILD'S PRODUCTS ARE NOT AUTHORIZED FOR USE AS CRITICAL COMPONENTS IN LIFE SUPPORT DEVICES OR SYSTEMS WITHOUT THE EXPRESS WRITTEN APPROVAL OF FAIRCHILD SEMICONDUCTOR CORPORATION.

As used herein:

1. Life support devices or systems are devices or systems which, (a) are intended for surgical implant into the body or (b) support or sustain life, and (c) whose failure to perform when properly used in accordance with instructions for use provided in the labeling, can be reasonably expected to result in a significant injury of the user.
2. A critical component in any component of a life support, device, or system whose failure to perform can be reasonably expected to cause the failure of the life support device or system, or to affect its safety or effectiveness.

ANTI-COUNTERFEITING POLICY

Fairchild Semiconductor Corporation's Anti-Counterfeiting Policy. Fairchild's Anti-Counterfeiting Policy is also stated on our external website, www.fairchildsemi.com, under Sales Support.

Counterfeiting of semiconductor parts is a growing problem in the industry. All manufacturers of semiconductor products are experiencing counterfeiting of their parts. Customers who inadvertently purchase counterfeit parts experience many problems such as loss of brand reputation, substandard performance, failed applications, and increased cost of production and manufacturing delays. Fairchild is taking strong measures to protect ourselves and our customers from the proliferation of counterfeit parts. Fairchild strongly encourages customers to purchase Fairchild parts either directly from Fairchild or from Authorized Fairchild Distributors who are listed by country on our web page cited above. Products customers buy either from Fairchild directly or from Authorized Fairchild Distributors are genuine parts, have full traceability, meet Fairchild's quality standards for handling and storage and provide access to Fairchild's full range of up-to-date technical and product information. Fairchild and our Authorized Distributors will stand behind all warranties and will appropriately address any warranty issues that may arise. Fairchild will not provide any warranty coverage or other assistance for parts bought from Unauthorized Sources. Fairchild is committed to combat this global problem and encourage our customers to do their part in stopping this practice by buying direct or from authorized distributors.

PRODUCT STATUS DEFINITIONS

Definition of Terms

Datasheet Identification	Product Status	Definition
Advance Information	Formative / In Design	Datasheet contains the design specifications for product development. Specifications may change in any manner without notice.
Preliminary	First Production	Datasheet contains preliminary data; supplementary data will be published at a later date. Fairchild Semiconductor reserves the right to make changes at any time without notice to improve design.
No Identification Needed	Full Production	Datasheet contains final specifications. Fairchild Semiconductor reserves the right to make changes at any time without notice to improve the design.
Obsolete	Not In Production	Datasheet contains specifications on a product that is discontinued by Fairchild Semiconductor. The datasheet is for reference information only.