

LH4004/LH4004C Wideband FET-Input Buffer/Amplifier

General Description

The LH4004 is an FET input, high speed differential amplifier optimized for unity gain applications. It eliminates most of the drawbacks of conventional open loop buffers and does not require compensation for unity and other low gain operations. It is an ideal choice for video distribution, driving flash converters, and summing amplifiers. Furthermore, the bandwidth does not decrease with increasing gain. At a closed loop gain of 4, the LH4004 still offers a 75 MHz bandwidth.

Features

- ± 0.5 dB gain flatness
- 500 V/ μ s slew rate
- Drives 50 Ω directly
- 140 MHz bandwidth
- No external components required for unity gain operation
- Internal power supply bypassing

Applications

- Unity gain buffer
- Low gain op amp

Simplified Schematic and Connection Diagram

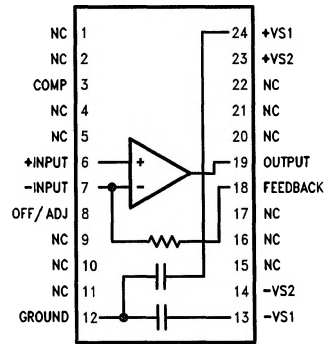
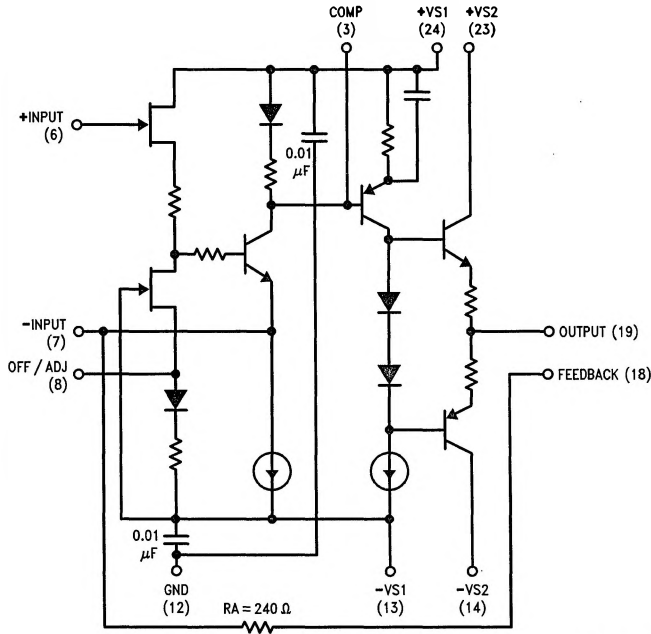

TL/K/8831-2

Top View

Order Number
LH4004CD or LH4004D
 See NS Package Number D24D

TL/K/8831-1

Absolute Maximum Ratings

If Military/Aerospace specified devices are required, please contact the National Semiconductor Sales Office/Distributors for availability and specifications.

Supply Voltage, V_S	$\pm 15V$
Power Dissipation, P_D	
$T_A = 25^\circ C$, derate linearly at $80^\circ C/W$	1.8W
$T_C = 25^\circ C$, derate linearly at $40^\circ C/W$	3.75W
Input Voltage Range, V_{IN}	$\pm V_S$

Operating Temperature Range, T_A	
LH4004CD	$-25^\circ C$ to $+85^\circ C$
LH4004D	$-55^\circ C$ to $+125^\circ C$
Storage Temperature Range, T_{STG}	$-65^\circ C$ to $+150^\circ C$
Maximum Junction Temperature, T_J	$150^\circ C$
Lead Temperature (Soldering, < 10 sec)	$300^\circ C$
ESD rating is to be determined.	

DC Electrical Characteristics $V_S = \pm 12V$, $R_S = R_L = 50\Omega$, $T_A = 25^\circ C$ unless otherwise noted (Note 1)

Symbol	Parameter	Conditions	LH4004C			Units (Max Unless Otherwise Stated)	
			Typ	Tested Limit (Note 2)	Design Limit (Note 3)		
V_{OS}	Input Offset Voltage	$V_{IN} = 0V$, $T_A = T_J = 25^\circ C$ (Note 4)	8	15		mV	
$V_{OS}/\Delta T$	Offset Voltage Drift		300			$\mu V/^\circ C$	
I_B	Input Bias Current	$T_J = 25^\circ C$, Pin 6 (Note 4)		400		pA	
	Gain Accuracy	$V_{IN} = \pm 1V$ $A_V = +1$	$R_L = 500\Omega$	0.98	0.96	0.93	V/V (Min)
			$R_L = 50\Omega$	0.98	0.96	0.93	
V_O	Output Voltage Swing	$V_{IN} = \pm 10V$	$R_L = 500\Omega$	9.6	9.2	9.2	V (Min)
V_O	Output Voltage Current Swing	$V_{IN} = \pm 5V$, $R_L = 50\Omega$		± 4.5	± 4		V (Min)
I_S	Supply Current			35	40		mA
PSRR	Power Supply Rejection Ratio	$\pm V_S = \pm 11V$ to $\pm 15V$			40		dB (Min)

AC Electrical Characteristics $V_S = \pm 12V$, $R_S = R_L = 50\Omega$, $T_A = 25^\circ C$ (unless otherwise noted)

Symbol	Parameter	Conditions	LH4004C			Units (Max Unless Otherwise Stated)
			Typ	Tested Limit (Note 2)	Design Limit (Note 3)	
t_r	Small Signal Rise Time	$\Delta V_{IN} = 0.5V$	3			ns
t_s	Settling Time to 0.5%	$V_{IN} = -2.5V$ to $+2.5V$	30			ns
f_{-3dB}	Small Signal Bandwidth	$V_{IN} = -10$ dBm	$A_V = +1$	140	125	MHz (Min)
			$A_V = +4$	85	75	
	Large Signal Bandwidth	$V_{OUT} = \pm 2.5V$			70	MHz
	Gain Flatness	$V_{IN} = -10$ dBm $A_V = +1$ $f = 0-50$ MHz			± 0.5	dB
	Harmonic Distortion	Second Order $V_{IN} = 4V_{p-p}$, $f_{IN} = 10$ MHz				dB
SR	Slew Rate	$V_{IN} = -2.5V$ to $+2.5V$	1500		1200	V/ μs (Min)
		$V_{IN} = +2.5V$ to $-2.5V$	600		500	

DC Electrical Characteristics

$V_S = \pm 12V$, $R_S = R_L = 50\Omega$, $T_A = 25^\circ C$ unless otherwise noted (Notes 1 & 5)

Symbol	Parameter	Conditions	LH4004			Units (Max Unless Otherwise Stated)
			Typ	Tested Limit (Note 2)	Design Limit (Note 3)	
V_{OS}	Input Offset Voltage	$T_A = T_J = 25^\circ C$ (Note 4)	8	15		mV
$V_{OS}/\Delta T$	Offset Voltage Drift		300			$\mu V/^\circ C$
I_B	Input Bias Current	$T_A = T_J = 25^\circ C$, Pin 6 (Note 4)		400		pA
				400		nA
	Gain Accuracy	$V_{IN} = \pm 1V$ $A_V = +1$	$R_L = 500\Omega$	0.98	0.96	V/V (Min)
					0.93	
		$R_L = 50\Omega$	0.98	0.96		
				0.93		
V_O	Output Voltage Swing	$V_{IN} = \pm 10V$	$R_L = 500\Omega$	9.6	9.2	V (Min)
V_O	Output Voltage Swing	$V_{IN} = \pm 5V$, $R_L = 50\Omega$		± 4.5	± 4	V (Min)
I_S	Supply Current			35	40	
PSRR	Power Supply Rejection Ratio				40	dB (Min)

AC Electrical Characteristics $V_S = \pm 12V$, $R_S = R_L = 50\Omega$, $T_A = 25^\circ C$ unless otherwise noted

Symbol	Parameter	Conditions	LH4004			Units (Max Unless Otherwise Stated)
			Typ	Tested Limit (Note 2)	Design Limit (Note 3)	
t_r	Small Signal Rise Time	$\Delta V_{IN} = 0.5V$	3			ns
t_s	Settling Time to 0.5%	$V_{IN} = -2.5V$ to $+2.5V$	30			ns
f_{-3dB}	Small Signal Bandwidth	$V_{IN} = -10$ dBm	$A_V = +1$	125		MHz (Min)
			$A_V = +4$	75		
	Large Signal Bandwidth	$V_{OUT} = \pm 2.5V$	$A_V = +1$	70		MHz
	Gain Flatness	$V_{IN} = 100$ mV p-p $A_V = +1$ $f = 0-50$ MHz		± 0.5		dB
	Harmonic Distortion	Second Order $V_{IN} = 4V$ p-p, $f_{IN} = 10$ MHz				dB
SR	Slew Rate	$V_{IN} = -2.5V$ to $+2.5V$	1500		1200	V/ μs (Min)
		$V_{IN} = +2.5V$ to $-2.5V$	600		500	

Note 1: Boldface limits are guaranteed over full temperature range. Operating ambient temperature range of LH4004C is $-25^\circ C$ to $+85^\circ C$, and LH4004 is $-55^\circ C$ to $+125^\circ C$.

Note 2: Tested limits are guaranteed and 100% production tested.

Note 3: Design limits are guaranteed (but not 100% production tested) over the indicated temperature range. These limits are not used to calculate outgoing quality levels.

Note 4: Specification is at $25^\circ C$ junction temperature due to requirements of high speed automatic testing. Actual values at operating temperature will exceed value at $T_J = 25^\circ C$.

Note 5: When the LH4004 is operated at elevated temperature (such as $125^\circ C$), some form of heat sinking or forced air cooling is required. The quiescent power with V_S of $\pm 12V$ is 960 mW, whereas the package is only rated to 800 mW without a heatsink at $125^\circ C$.

Application Hints

The front page figure shows the simplified schematic which includes the feedback resistor and the decoupling capacitors.

The essential difference from other op amps is that both inputs are radically different, the non-inverting input goes to a FET buffer follower and the inverting input is connected to the second stage emitter node. This topology is responsible for the unique bandwidth characteristic and transfer function of the amplifier.

Let's consider the connection diagram of *Figure 1*. The typical transfer function in the case of a classical op amp would be:

$$\frac{V_{OUT}}{V_{IN}} = \frac{K(s)}{1 + K(s)/B}$$

where $B = \frac{R_A + R_B}{R_B}$ and $K(s)$ is the open loop gain of the amplifier and is frequency dependent. By rearranging the formula, we find;

$$(1) \quad \frac{V_{OUT}}{V_{IN}} = B \cdot \frac{K(s)}{K(s) + B}$$

For the LH4004, a small signal analysis shows that the difference between the two inputs turns the previous typical equation into:

$$(2) \quad \frac{V_{OUT}}{V_{IN}} = B \cdot \frac{K(s)}{K(s) + B + mR_A}$$

where m is an internal parameter to the device and $K(s)$ is approximately 70 dB at DC with a 50Ω load.

In both equations, the second term is negligible when the open loop gain of the amplifier, $K(s)$, approaches infinity, but in equation (1), when the signal frequency reaches a point where $K(s)$ is small, say $K(s) = 10$ or less, then the term will be very sensitive to the value of the closed loop gain B and V_{OUT}/V_{IN} will fall earlier as B increases.

In equation (2), m is approximately 0.19 and R_A is provided inside the package, with a value which has been chosen to be 240Ω. The term mR_A is therefore equal to 46 and will dominate the term B as long as it is kept below 5. The result is that V_{OUT}/V_{IN} will not be as dependent on B as with traditional topologies. The gain will still fall with the open loop gain $K(s)$ as the frequency increases, but the roll off will be virtually independent of the closed loop gain B .

Resistor R_B sets the overall closed loop gain, but has very little effect on stability and bandwidth. Another peculiarity of the LH4004 is that the loop compensation can be accomplished by changing the value of resistor R_A (*Figure 2*). Even though this such as settling time, overshoot and phase margin, it will not affect the slew rate. Although this resistive compensation scheme is adequate in most cases, an alternate method is to place a capacitor between pins 3 and 19 (*Figure 3*). This method of compensation also reduces the device slew rate (*Figure 4*).

Low Gain Operation

The small amount of stray capacitance present at the inverting input can cause peaking which increases with decreasing gain. The gain set resistor R_B (in *Figure 1*) is effectively

in parallel with this capacitance and so a frequency domain pole results. With a small R_B , this pole is at a high frequency and it affects the closed loop gain of the LH4004 only slightly. At lower values of gain, this pole becomes significant. For example, at a gain of +2, the gain may peak as much as 1.5 dB to 2 dB at 100 MHz.

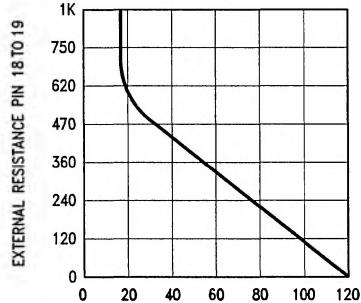

BANDWIDTH IN MHz FOR UNITY GAIN CONFIGURATION

TL/K/8831-10

FIGURE 2. Bandwidth vs R_{ext}

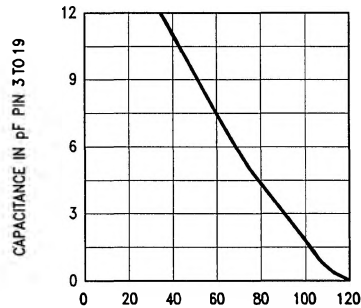

BANDWIDTH IN MHz FOR UNITY GAIN CONFIGURATION

TL/K/8831-11

FIGURE 3. Bandwidth vs C_{ext}

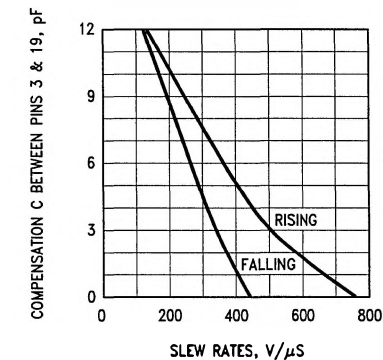

SLEW RATES, V/μS

TL/K/8831-13

FIGURE 4. Slew Rates vs Compensation C

Typical Applications

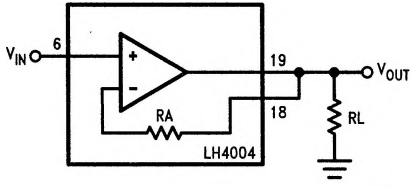
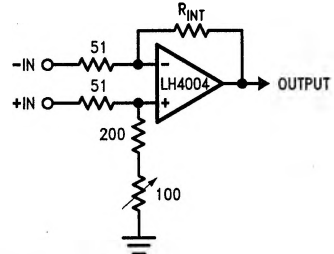

FIGURE 5. Unity Gain Buffer

TL/K/8831-4



Note: Adjust pot for best CMRR.

FIGURE 6. Differential Amplifier

TL/K/8831-12

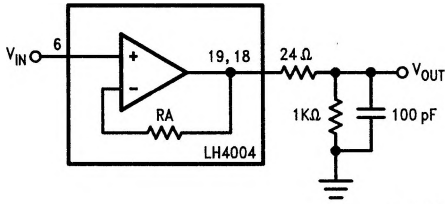

FIGURE 7. Driving Capacitive Loads

TL/K/8831-5

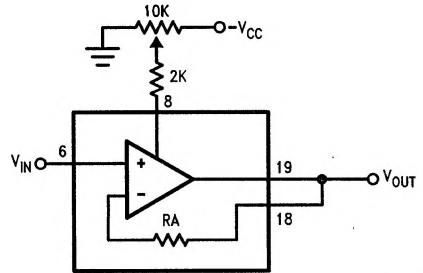

FIGURE 8. Offset Adjust

TL/K/8831-6

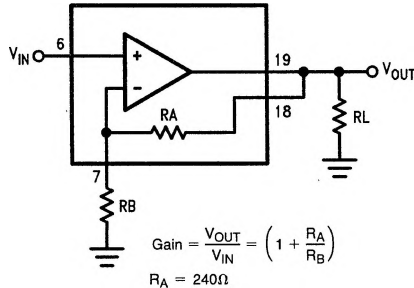
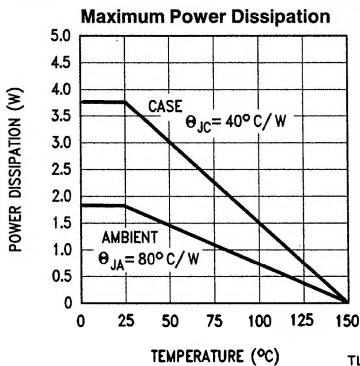

FIGURE 9. LH4004 Used in Amplifier Applications

TL/K/8831-7

Typical Performance Characteristics



TL/K/8831-8

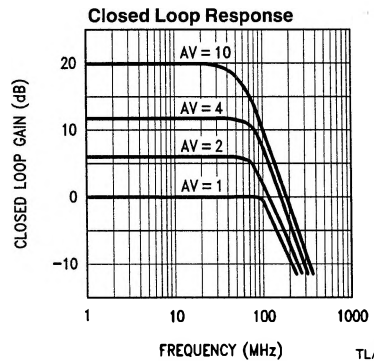

TL/K/8831-9

Typical Performance Characteristics (Continued)

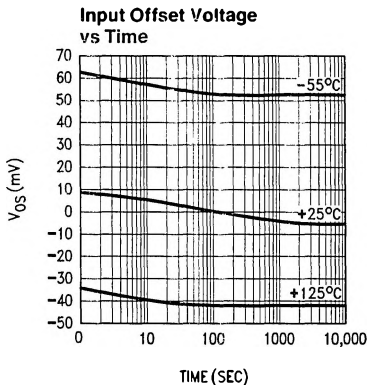

TL/K/8831-14

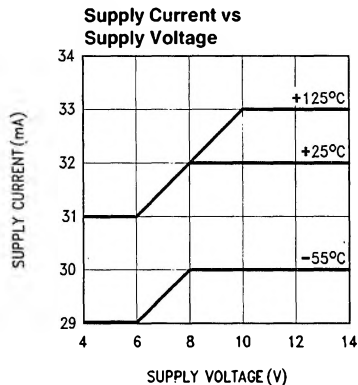

TL/K/8831-15

Large Signal Pulse Response

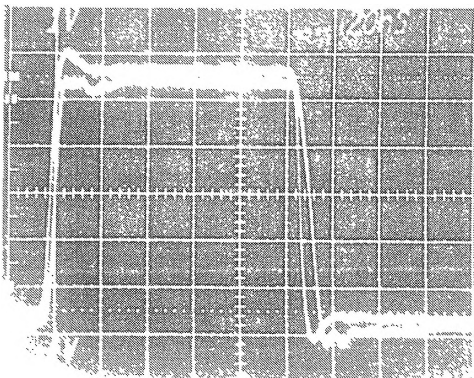

TL/K/8831-16

Top Trace = Input
Bottom Trace = Output

Small Signal Pulse Response

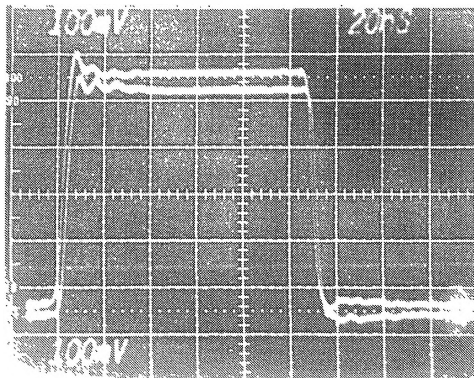

TL/K/8831-17

Top Trace = Input
Bottom Trace = Output