

LH0101,LH0101A,LH0101AC,LH0101C

LH0101 LH0101A LH0101AC LH0101C Power Operational Amplifier



Literature Number: SNOSBF9A

LH0101 Power Operational Amplifier

General Description

The LH0101 is a wideband power operational amplifier featuring FET inputs, internal compensation, virtually no crossover distortion, and rapid settling time. These features make the LH0101 an ideal choice for DC or AC servo amplifiers, deflection yoke drives, programmable power supplies, and disk head positioner amplifiers. The LH0101 is packaged in an 8 pin TO-3 hermetic package, rated at 60 watts with a suitable heat sink.

Features

- 5 Amp peak, 2 Amp continuous output current
- 300 kHz power bandwidth
- 850 mW standby power ($\pm 15V$ supplies)
- 300 pA input bias current
- 10 V/ μs slew rate
- Virtually no crossover distortion
- 2 μs settling time to 0.01%
- 5 MHz gain bandwidth

Schematic and Connection Diagrams

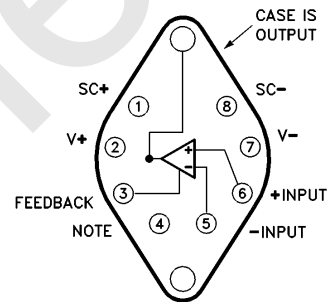
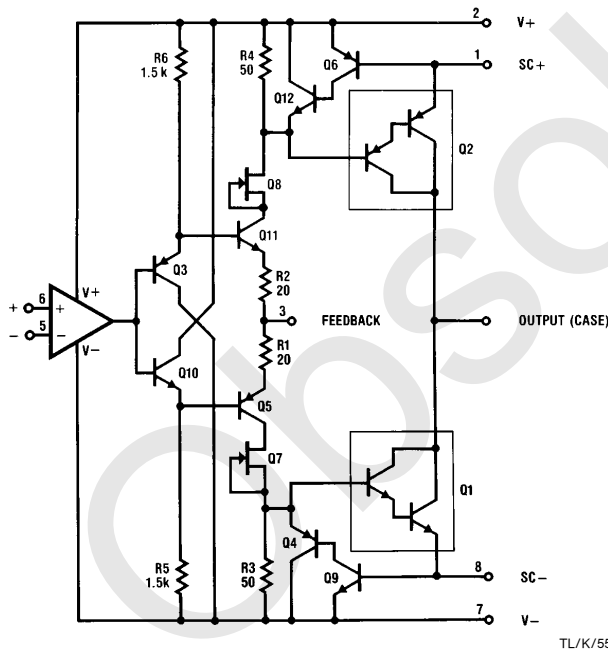

Top View

**Order Numbers LH0101K,
LH0101K-MIL, LH0101CK,
LH0101AK,
LH0101AK-MIL or LH0101ACK
See NS Package Number K08A**

Note: Electrically connected internally, no connection should be made to pin.

Absolute Maximum Ratings

If Military/Aerospace specified devices are required, please contact the National Semiconductor Sales Office/Distributors for availability and specifications. (Note 5)

Supply Voltage, V_S	$\pm 22V$
Power Dissipation at $T_A = 25^\circ C$, P_D	5W
Derate linearly at $25^\circ C/W$ to zero at $150^\circ C$,	
Power Dissipation at $T_C = 25^\circ C$	62W
Derate linearly at $2^\circ C/W$ to zero at $150^\circ C$	
Differential Input Voltage, V_{IN}	$\pm 40V$ but $< \pm V_S$
Input Voltage Range, V_{CM}	$\pm 20V$ but $< \pm V_S$
Thermal Resistance—	
See Typical Performance Characteristics	

Peak Output Current (50 ms pulse), $I_{O(PK)}$	5A
Output Short Circuit Duration (within rated power dissipation, $R_{SC} = 0.35\Omega$, $T_A = 25^\circ C$)	Continuous
Operating Temperature Range, T_A	
LH0101AC, LH0101C	$-25^\circ C$ to $+85^\circ C$
LH0101A, LH0101	$-55^\circ C$ to $+125^\circ C$
Storage Temperature Range, T_{STG}	$-65^\circ C$ to $+150^\circ C$
Maximum Junction Temperature, T_J	$150^\circ C$
Lead Temperature (Soldering < 10 sec.)	$260^\circ C$
ESD rating to be determined.	

DC Electrical Characteristics (Note 1) $V_S = \pm 15V$, $T_A = 25^\circ C$ unless otherwise noted

Symbol	Parameter	Conditions	LH0101AC LH0101A			LH0101C LH0101			Units
			Min	Typ	Max	Min	Typ	Max	
V_{OS}	Input Offset Voltage			1	3		5	10	mV
		$T_{MIN} \leq T_A \leq T_{MAX}$			7			15	
$\Delta V_{OS}/\Delta P_D$	Change in Input Offset Voltage with Dissipated Power	(Note 2)		150			300		$\mu V/W$
$\Delta V_{OS}/\Delta T$	Change in Input Offset Voltage with Temperature	$V_{CM} = 0$		10			10		$\mu V/^\circ C$
I_B	Input Bias Current				300			1000	pA
		$T_A \leq T_{MAX}$	LH0101C/AC		60			60	nA
			LH0101/A		300			1000	
I_{OS}	Input Offset Current				75			250	pA
		$T_A \leq T_{MAX}$	LH0101C/AC		15			15	nA
			LH0101/A		75			250	
A_{VOL}	Large Signal Voltage Gain	$V_O = \pm 10V$, $R_L = 10\Omega$	50	200		50	200		V/mV
V_O	Output Voltage Swing	$R_{SC} = 0$	$R_L = 100\Omega$	± 12	± 12.5		± 12	± 12.5	V
		$A_V = +1$	$R_L = 10\Omega$	± 11.25	± 11.6		± 11.25	± 11.6	
		Note 3	$R_L = 5\Omega$	± 10.5	± 11		± 10.5	± 11	
CMRR	Common Mode Rejection Ratio	$\Delta V_{IN} = \pm 10V$	85	100		85	100		dB
PSRR	Power Supply Rejection Ratio	$\Delta V_S = \pm 5V$ to $\pm 15V$	85	100		85	100		
I_S	Quiescent Supply Current			28	35		28	35	mA

AC Electrical Characteristics (Note 1), $V_S = \pm 15V$, $T_A = 25^\circ C$

Symbol	Parameter	Conditions	LH0101 LH0101A			LH0101C LH0101AC			Units
			Min	Typ	Max	Min	Typ	Max	
e_n	Equivalent Input Noise Voltage	$f = 1 \text{ kHz}$		25			25		nV/\sqrt{Hz}
C_{IN}	Input Capacitance	$f = 1 \text{ MHz}$		3.0			3.0		pF
	Power Bandwidth, -3 dB			300			300		kHz
SR	Slew Rate	$R_L = 10\Omega$	$A_V = +1$	7.5 (Note 4)	10		10		$V/\mu s$
t_r, t_f	Small Signal Rise or Fall Time				200		200		ns
	Small Signal Overshoot			10		10		%	
GBW	Gain-Bandwidth Product	$R_L = \infty$		4.0 (Note 4)	5.0		5.0		MHz
t_s	Large Signal Settling Time to 0.01%			2.0		2.0		μs	
THD	Total Harmonic Distortion	$P_O = 10W, f = 1 \text{ kHz}$ $R_L = 10\Omega$		0.008			0.008		%

Note 1: Specification is at $T_A = 25^\circ C$. Actual values at operating temperature may differ from the $T_A = 25^\circ C$ value. When supply voltages are $\pm 15V$, quiescent operating junction temperature will rise approximately $20^\circ C$ without heat sinking. Accordingly, V_{OS} may change 0.5 mV and I_B and I_{OS} will change significantly during warm-ups. Refer to the I_B vs. temperature and power dissipation graphs for expected values. Power supply voltage is $\pm 15V$. Temperature tests are made only at extremes.

Note 2: Change in offset voltage with dissipated power is due entirely to average device temperature rise and not to differential thermal feedback effects. Test is performed without any heat sink.

Note 3: At light loads, the output swing may be limited by the second stage rather than the output stage. See the application section under "Output swing enhancement" for hints on how to obtain extended operation.

Note 4: These parameters are sample tested to 10% LTPD.

Note 5: Refer to RETS0101AK for the LH0101AK military specifications and RETS0101K for the LH0101K military specifications.

Typical Performance Characteristics

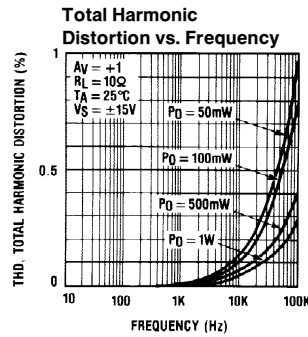
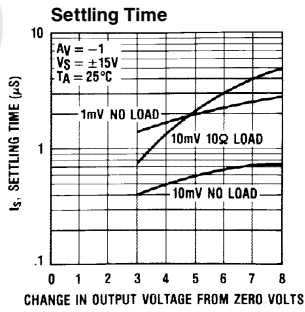
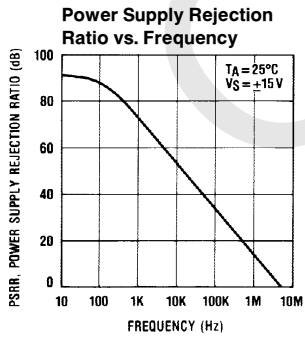
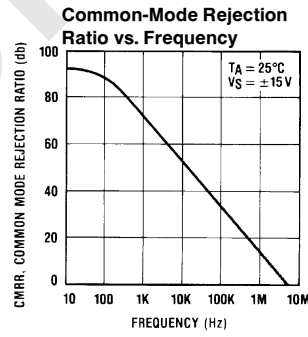
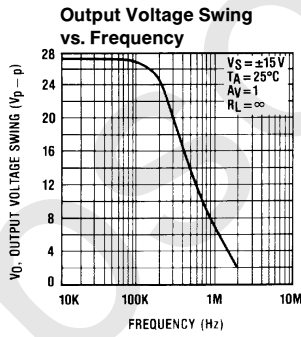
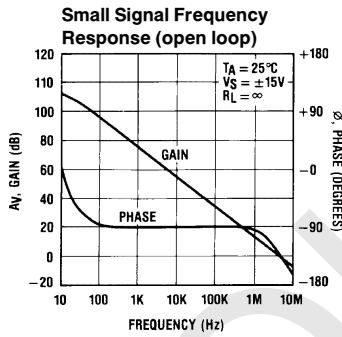
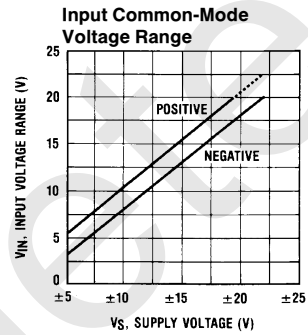
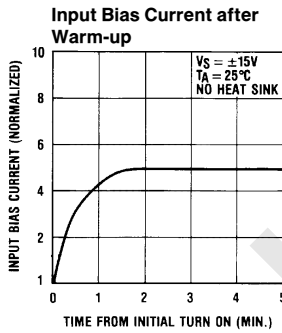
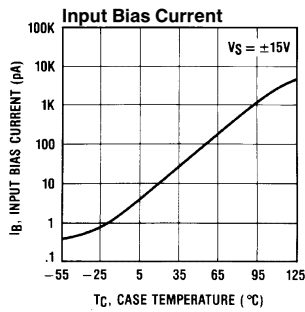
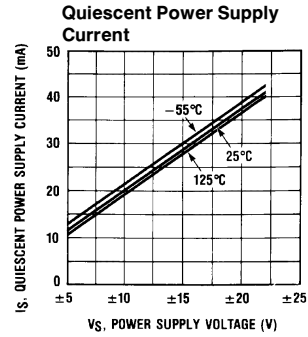
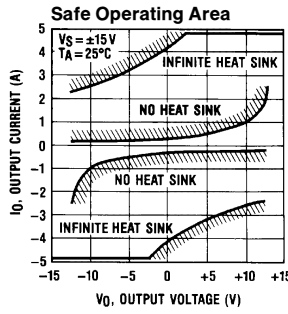
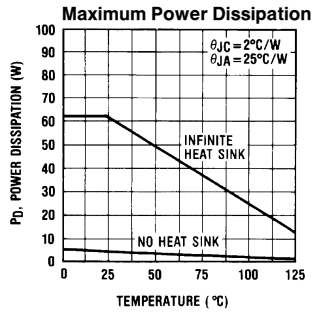

TL/K/5558-3

Typical Performance Characteristics (Continued)

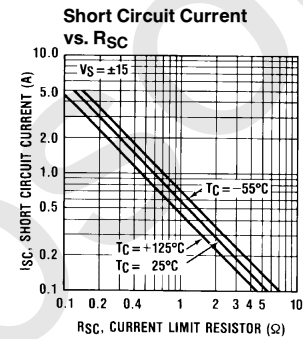
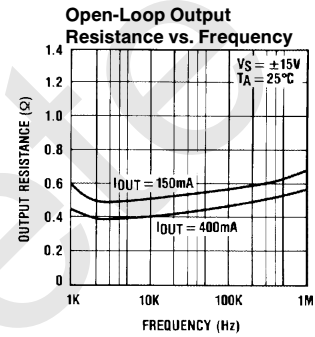
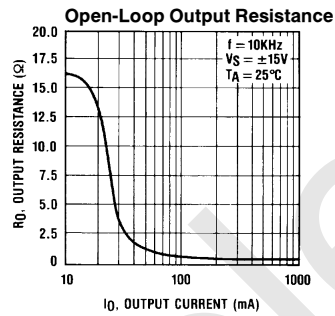
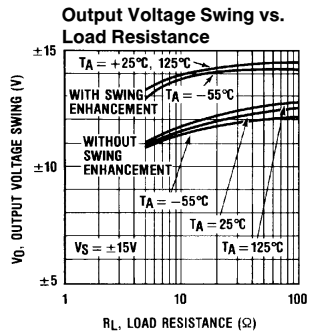
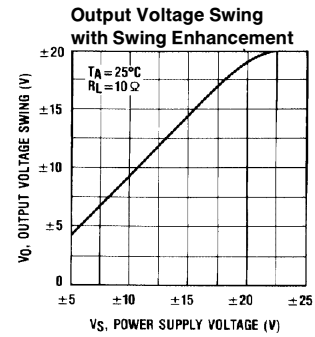
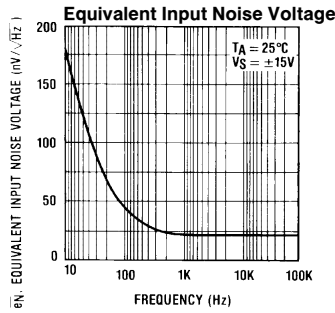
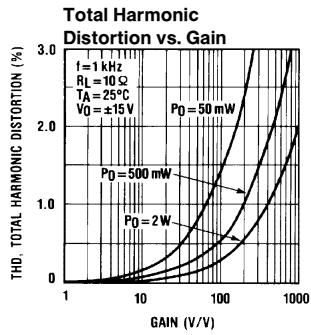

TL/K/5558-4

Small Signal Pulse Response (No Load)

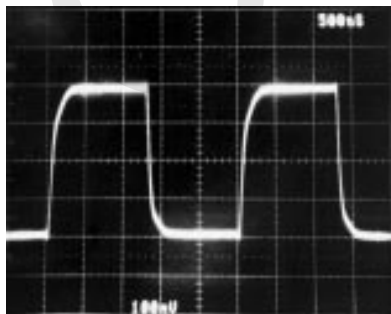

TL/K/5558-5

Large Signal Pulse Response ($R_L = 10\Omega$)

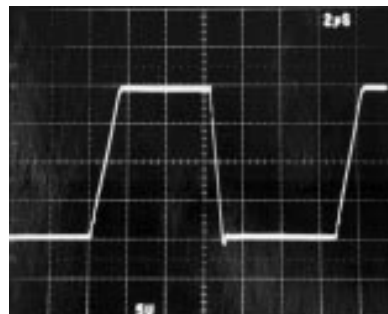

TL/K/5558-6

Application Hints

Input Voltages

The LH0101 operational amplifier contains JFET input devices which exhibit high reverse breakdown voltages from gate to source or drain. This eliminates the need for input clamp diodes, so that high differential input voltages may be applied without a large increase in input current. However, neither input voltage should be allowed to exceed the negative supply as the resultant high current flow may destroy the unit.

Exceeding the negative common-mode limit on either input will cause a reversal of the phase to the output and force the amplifier output to the corresponding high or low state. Exceeding the negative common-mode limit on both inputs will force the amplifier output to a high state. In neither case does a latch occur since raising the input back within the common-mode range again puts the input stage and thus the amplifier in a normal operating mode.

Exceeding the positive common-mode limit on a single input will not change the phase of the output however, if both inputs exceed the limit, the output of the amplifier will be forced to a high state.

These amplifiers will operate with the common-mode input voltage equal to the positive supply. In fact, the common-mode voltage may exceed the positive supply by approximately 100 mV, independent of supply voltage and over the full operating temperature range. The positive supply may therefore be used as a reference on an input as, for example, in a supply current monitor and/or limiter.

With the LH0101 there is a temptation to remove the bias current compensation resistor normally used on the non-inverting input of a summing amplifier. Direct connection of the inputs to ground or a low-impedance voltage source is not recommended with supply voltages greater than 3V. The potential problem involves loss of one supply which can cause excessive current in the second supply. Destruction of the IC could result if the current to the inputs of the device is not limited to less than 100 mA or if there is much more than 1 μ F bypass on the supply buss.

Although difficulties can be largely avoided by installing clamp diodes across the supply lines on every PC board, a conservative design would include enough resistance in the input lead to limit current to 10 mA if the input lead is pulled to either supply by internal currents. This precaution is by no means limited to the LH0101.

Layout Considerations

When working with circuitry capable of resolving pico-ampere level signals, leakage currents in circuitry external to the op amp can significantly degrade performance. High quality insulation is a must (Kel-F and Teflon rate high). Proper cleaning of all insulating surfaces to remove fluxes and other residues is also required. This includes the IC package as well as sockets and printed circuit boards. When operating in high humidity environments or near 0°C, some form of surface coating may be necessary to provide a moisture barrier.

The effects of board leakage can be minimized by encircling the input circuitry with a conductive guard ring operated at a potential close to that of the inputs.

Electrostatic shielding of high impedance circuitry is advisable.

Error voltages can also be generated in the external circuitry. Thermocouples formed between dissimilar metals can cause hundreds of microvolts of error in the presence of temperature gradients.

Since the LH0101 can deliver large output currents, careful attention should be paid to power supply, power supply bypassing and load currents. Incorrect grounding of signal inputs and load can cause significant errors.

Every attempt should be made to achieve a single point ground system as shown in the figure below.

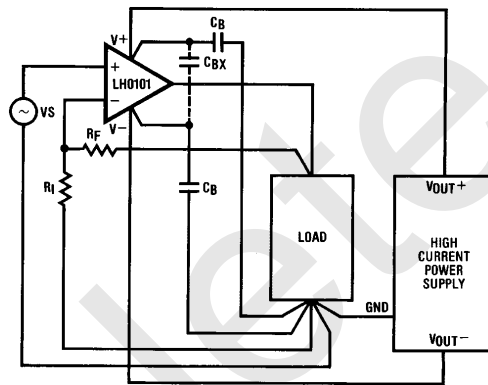

FIGURE 1. Single-Point Grounding

Bypass capacitor C_{BX} should be used if the lead lengths of bypass capacitors C_B are long. If a single point ground system is not possible, keep signal, load, and power supply from intermingling as much as possible. For further information on proper grounding techniques refer to "Grounding and Shielding Techniques in Instrumentation" by Morrison, and "Noise Reduction Techniques in Electronic Systems" by Ott (both published by John Wiley and Sons).

Leads or PC board traces to the supply pins, short-circuit current limit pins, and the output pin must be substantial enough to handle the high currents that the LH0101 is capable of producing.

Short Circuit Current Limiting

Should current limiting of the output not be necessary, SC+ should be shorted to V_+ and SC- should be shorted to V_- . Remember that the short circuit current limit is dependent upon the total resistance seen between the supply and current limit pins. This total resistance includes the desired resistor plus leads, PC Board traces, and solder joints.* Assuming a zero TCR current limit resistor, typical temperature coefficient of the short circuit current will be approximately .3%/°C.

*Short circuit current will be limited to approximately $\frac{0.6}{R_{SC}}$.

Application Hints (Continued)

Thermal Resistance

The thermal resistance between two points of a conductive system is expressed as:

$$\theta_{12} = \frac{T_1 - T_2}{P_D} \text{ } ^\circ\text{C/W}$$

where subscript order indicates the direction of heat flow. A simplified heat transfer circuit for a cased semiconductor and heat sink system is shown in the figure below.

The circuit is valid only if the system is in thermal equilibrium (constant heat flow) and there are, indeed, single specific temperatures T_J , T_C and T_S (no temperature distribution in junction, case, or heat sink). Nevertheless, this is a reasonable approximation of actual performance.

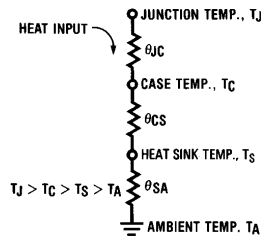

TL/K/5558-8

FIGURE 2. Semiconductor-Heat Sink Thermal Circuit

The junction-to-case thermal resistance θ_{JC} specified in the data sheet depends upon the material and size of the package, die size and thickness, and quality of the die bond to the case or lead frame. The case-to-heat sink thermal resistance θ_{CS} depends on the mounting of the device to the heat sink and upon the area and quality of the contact surface. Typical θ_{CS} for a TO-3 package is 0.5 to 0.7°C/W, and 0.3 to 0.5°C/W using silicone grease.

The heat sink to ambient thermal resistance θ_{SA} depends on the quality of the heat sink and the ambient conditions.

Cooling is normally required to maintain the worst case operating junction temperature T_J of the device below the specified maximum value $T_{J(MAX)}$. T_J can be calculated from known operating conditions. Rewriting the above equation, we find:

$$\theta_{JA} = \frac{T_J - T_A}{P_D} \text{ } ^\circ\text{C/W}$$

$$T_J = T_A + P_D \theta_{JA} \text{ } ^\circ\text{C}$$

Where: $P_D = (V_S - V_{OUT})I_{OUT} + |V_+ - (V_-)|I_Q$
for a DC Signal

$\theta_{JA} = \theta_{JC} + \theta_{CS} + \theta_{SA}$ and $V_S =$ Supply Voltage

θ_{JC} for the LH0101 is about 2°C/W.

Stability and Compensation

As with most amplifiers, care should be taken with lead dress, component placement and supply decoupling in order to ensure stability. For example, resistors from the output to an input should be placed with the body close to the input to minimize "pickup" and maximize the frequency of the feedback pole by minimizing the capacitance from the input to ground.

A feedback pole is created when the feedback around any amplifier is resistive. The parallel resistance and capacitance from the input device (usually the inverting input) to ac

ground set the frequency of the pole. In many instances the frequency of this pole is much greater than the expected 3 dB frequency of the closed loop gain and consequently there is negligible effect on stability margin. However, if the feedback pole is less than approximately six times the expected 3 dB frequency a lead capacitor should be placed from the output to the input of the op amp. The value of the added capacitor should be such that the RC time constant of this capacitor and the resistance it parallels is greater than or equal to the original feedback pole time constant.

Some inductive loads may cause output stage oscillation. A .01 μF ceramic capacitor in series with a 10 Ω resistor from the output to ground will usually remedy this situation.

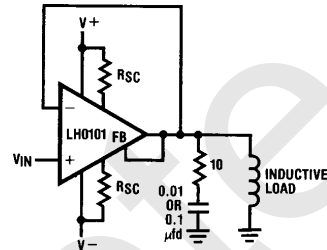

TL/K/5558-9

FIGURE 3. Driving Inductive Loads

Capacitive loads may be compensated for by traditional techniques. (See "Operational Amplifiers: Theory and Practice" by Roberge, published by Wiley):

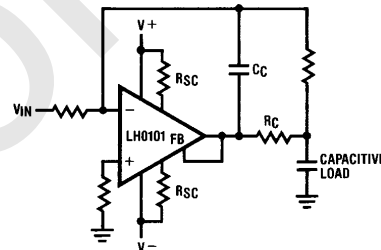

TL/K/5558-10

FIGURE 4. R_C and C_C Selected to Compensate for Capacitive Load

A similar but alternative technique may be used for the LH0101:

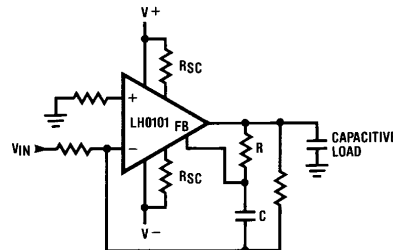

TL/K/5558-11

FIGURE 5. Alternate Compensation for Capacitive Load

Application Hints (Continued)

Output Swing Enhancement

When the feedback pin is connected directly to the output, the output voltage swing is limited by the driver stage and not by output saturation. Output swing can be increased as shown by taking gain in the output stage as shown in High Power Voltage Follower with Swing Enhancement below. Whenever gain is taken in the output stage, as in swing enhancement, either the output stage, or the entire op amp must be appropriately compensated to account for the additional loop gain.

Output Resistance

The open loop output resistance of the LH0101 is a function of the load current. No load output resistance is approximately 10Ω . This decreases to under 1Ω for load currents exceeding 100 mA.

Typical Applications

See AN261 for more information.

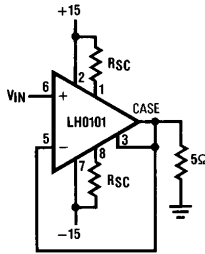

TL/K/5558-12

FIGURE 6. High Power Voltage Follower

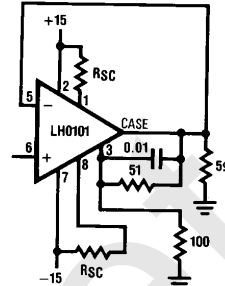

TL/K/5558-13

FIGURE 7. High Power Voltage Follower with Swing Enhancement

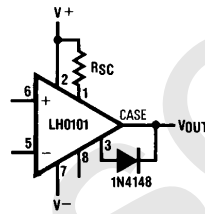

TL/K/5558-14

FIGURE 8. Restricting Outputs to Positive Voltages Only

Following is a partial list of sockets and heat dissipators for use with the LH0101. National assumes no responsibility for their quality or availability.

8-Lead TO-3 Hardware

SOCKETS

Keystone 4626 or 4627
Robinson Nugent 0002011
Azimuth 6028 (test socket)

AAVID Engineering
30 Cook Court
Laconia, New Hampshire 03246

Keystone Electronics Corp.
49 Bleecker St.
New York, NY 10012

HEAT SINKS

Thermalloy 2266B (35°C/W)
IERC LAIC3B4CB
IERC HP1-TO3-33CB (7°C/W)
AAVID 5791B

Azimuth Electronics
2377 S. El Camino Real
San Clemente, CA 92572

Robinson Nugent Inc.
800 E. 8th St.
New Albany, IN 47150

MICA WASHERS

Keystone 4658

IERC
135 W. Magnolia Blvd.
Burbank, CA 91502

Thermalloy
P.O. Box 34829
Dallas, TX 75234

Typical Applications (Continued)

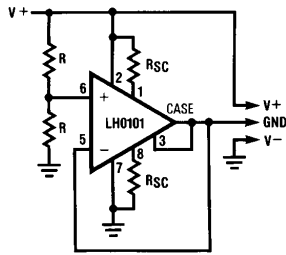

TL/K/5558-15

FIGURE 9. Generating a Split Supply from a Single Voltage Supply

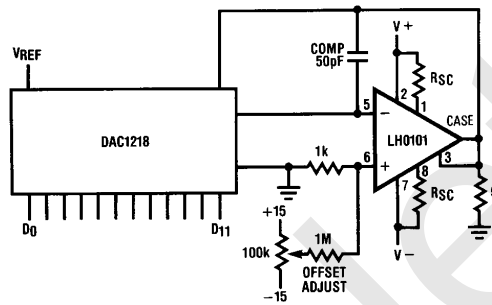

TL/K/5558-16

FIGURE 10. Power DAC

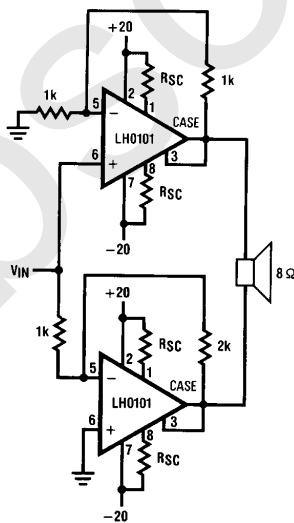

TL/K/5558-17

FIGURE 11. Bridge Audio Amplifier

Typical Applications (Continued)

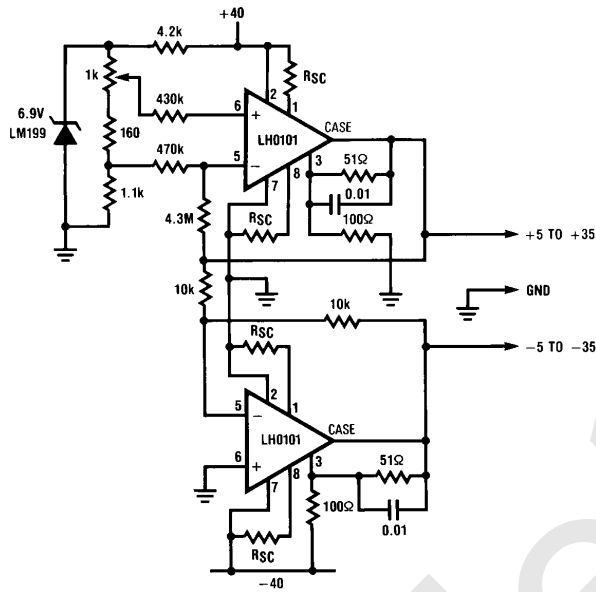

TL/K/5558-18

FIGURE 12. ±5 to ±35 Power Source or Sink

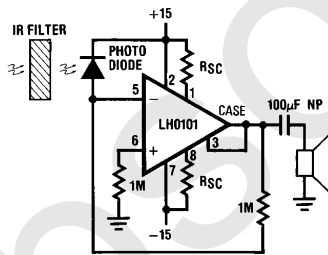

TL/K/5558-19

FIGURE 13. Remote Loudspeaker via Infrared Link

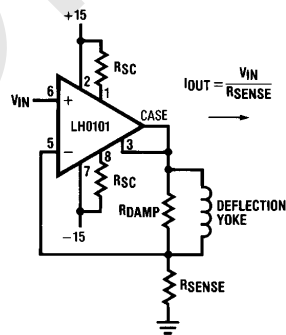

TL/K/5558-20

FIGURE 14. CRT Deflection Yoke Driver

Typical Applications (Continued)

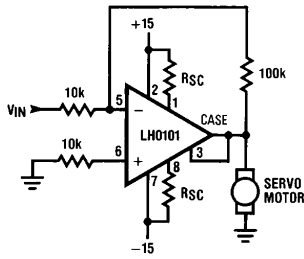

TL/K/5558-21

FIGURE 15. DC Servo Amplifier

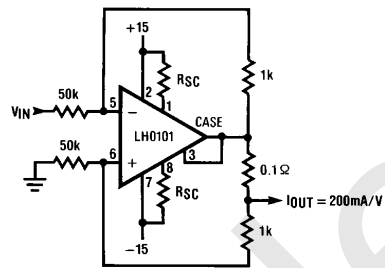

TL/K/5558-22

FIGURE 16. High Current Source/Sink

Physical Dimensions inches (millimeters)

Lit. # 106400

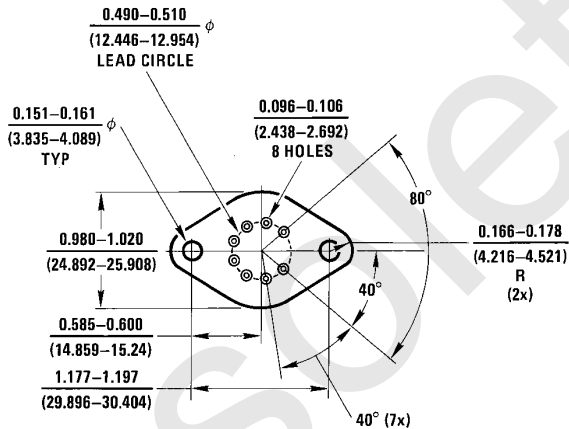
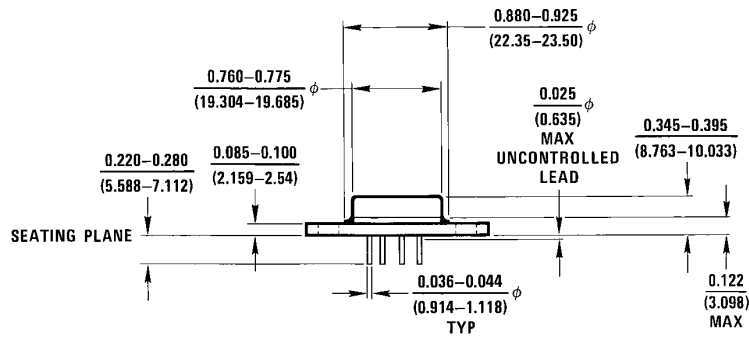

K08A (REV C)

8 Lead TO-3 Metal Can (K)
Order Number LH0101K, LH0101K-MIL, LH0101CK, LH0101AK, LH0101AK-MIL or LH0101ACK
NS Package Number K08A

LIFE SUPPORT POLICY

NATIONAL'S PRODUCTS ARE NOT AUTHORIZED FOR USE AS CRITICAL COMPONENTS IN LIFE SUPPORT DEVICES OR SYSTEMS WITHOUT THE EXPRESS WRITTEN APPROVAL OF THE PRESIDENT OF NATIONAL SEMICONDUCTOR CORPORATION. As used herein:

1. Life support devices or systems are devices or systems which, (a) are intended for surgical implant into the body, or (b) support or sustain life, and whose failure to perform, when properly used in accordance with instructions for use provided in the labeling, can be reasonably expected to result in a significant injury to the user.
2. A critical component is any component of a life support device or system whose failure to perform can be reasonably expected to cause the failure of the life support device or system, or to affect its safety or effectiveness.



National Semiconductor Corporation
 1111 West Bardin Road
 Arlington, TX 76017
 Tel: 1(800) 272-9959
 Fax: 1(800) 737-7018

National Semiconductor Europe
 Fax: (+49) 0-180-530 85 86
 Email: onjwge@tevm2.nsc.com
 Deutsch Tel: (+49) 0-180-530 85 85
 English Tel: (+49) 0-180-532 78 32
 Français Tel: (+49) 0-180-532 93 58
 Italiano Tel: (+49) 0-180-534 16 80

National Semiconductor Hong Kong Ltd.
 19th Floor, Straight Block,
 Ocean Centre, 5 Canton Rd.
 Tsimshatsui, Kowloon
 Hong Kong
 Tel: (852) 2737-1600
 Fax: (852) 2736-9960

National Semiconductor Japan Ltd.
 Tel: 81-043-299-2309
 Fax: 81-043-299-2408

National does not assume any responsibility for use of any circuitry described, no circuit patent licenses are implied and National reserves the right at any time without notice to change said circuitry and specifications.

IMPORTANT NOTICE

Texas Instruments Incorporated and its subsidiaries (TI) reserve the right to make corrections, modifications, enhancements, improvements, and other changes to its products and services at any time and to discontinue any product or service without notice. Customers should obtain the latest relevant information before placing orders and should verify that such information is current and complete. All products are sold subject to TI's terms and conditions of sale supplied at the time of order acknowledgment.

TI warrants performance of its hardware products to the specifications applicable at the time of sale in accordance with TI's standard warranty. Testing and other quality control techniques are used to the extent TI deems necessary to support this warranty. Except where mandated by government requirements, testing of all parameters of each product is not necessarily performed.

TI assumes no liability for applications assistance or customer product design. Customers are responsible for their products and applications using TI components. To minimize the risks associated with customer products and applications, customers should provide adequate design and operating safeguards.

TI does not warrant or represent that any license, either express or implied, is granted under any TI patent right, copyright, mask work right, or other TI intellectual property right relating to any combination, machine, or process in which TI products or services are used. Information published by TI regarding third-party products or services does not constitute a license from TI to use such products or services or a warranty or endorsement thereof. Use of such information may require a license from a third party under the patents or other intellectual property of the third party, or a license from TI under the patents or other intellectual property of TI.

Reproduction of TI information in TI data books or data sheets is permissible only if reproduction is without alteration and is accompanied by all associated warranties, conditions, limitations, and notices. Reproduction of this information with alteration is an unfair and deceptive business practice. TI is not responsible or liable for such altered documentation. Information of third parties may be subject to additional restrictions.

Resale of TI products or services with statements different from or beyond the parameters stated by TI for that product or service voids all express and any implied warranties for the associated TI product or service and is an unfair and deceptive business practice. TI is not responsible or liable for any such statements.

TI products are not authorized for use in safety-critical applications (such as life support) where a failure of the TI product would reasonably be expected to cause severe personal injury or death, unless officers of the parties have executed an agreement specifically governing such use. Buyers represent that they have all necessary expertise in the safety and regulatory ramifications of their applications, and acknowledge and agree that they are solely responsible for all legal, regulatory and safety-related requirements concerning their products and any use of TI products in such safety-critical applications, notwithstanding any applications-related information or support that may be provided by TI. Further, Buyers must fully indemnify TI and its representatives against any damages arising out of the use of TI products in such safety-critical applications.

TI products are neither designed nor intended for use in military/aerospace applications or environments unless the TI products are specifically designated by TI as military-grade or "enhanced plastic." Only products designated by TI as military-grade meet military specifications. Buyers acknowledge and agree that any such use of TI products which TI has not designated as military-grade is solely at the Buyer's risk, and that they are solely responsible for compliance with all legal and regulatory requirements in connection with such use.

TI products are neither designed nor intended for use in automotive applications or environments unless the specific TI products are designated by TI as compliant with ISO/TS 16949 requirements. Buyers acknowledge and agree that, if they use any non-designated products in automotive applications, TI will not be responsible for any failure to meet such requirements.

Following are URLs where you can obtain information on other Texas Instruments products and application solutions:

Products

Audio	www.ti.com/audio
Amplifiers	amplifier.ti.com
Data Converters	dataconverter.ti.com
DLP® Products	www.dlp.com
DSP	dsp.ti.com
Clocks and Timers	www.ti.com/clocks
Interface	interface.ti.com
Logic	logic.ti.com
Power Mgmt	power.ti.com
Microcontrollers	microcontroller.ti.com
RFID	www.ti-rfid.com
OMAP Mobile Processors	www.ti.com/omap
Wireless Connectivity	www.ti.com/wirelessconnectivity

Applications

Communications and Telecom	www.ti.com/communications
Computers and Peripherals	www.ti.com/computers
Consumer Electronics	www.ti.com/consumer-apps
Energy and Lighting	www.ti.com/energy
Industrial	www.ti.com/industrial
Medical	www.ti.com/medical
Security	www.ti.com/security
Space, Avionics and Defense	www.ti.com/space-avionics-defense
Transportation and Automotive	www.ti.com/automotive
Video and Imaging	www.ti.com/video

TI E2E Community Home Page

e2e.ti.com

Mailing Address: Texas Instruments, Post Office Box 655303, Dallas, Texas 75265
Copyright © 2011, Texas Instruments Incorporated