



LC737212, LC737212M

Telephone Dialer IC with On-Chip Memory for Push-Button Telephones

Overview

The LC737212 and LC737212M are CMOS LSI telephone dialers for pushbutton telephones. They support both DTMF and pulse dialing. These products include 25 16-digit memories for storing telephone numbers and one 63-digit memory for redialing, and they provide, in a single chip, all the functions required for dialing and control for a standard independent telephone, including on-hook dialing and a hold function. They also provide a serial I/O interface for connection to a microcontroller.

Functions

- Fabrication in a CMOS process that allows these circuits to be directly operated from a telephone line
- Support for single-contact keypads
- Built-in oscillator circuit ($f_{osc} = 3.58$ MHz) that can drive either a standard color-TV crystal oscillator element or a ceramic resonator
- High-precision DTMF signal
- Frequency generator circuit ($\pm 0.1\%$) adopted for eased ceramic resonator selection
- Five one-touch 16-digit auto-dial memories and 20 quick-dialing memories
- On-hook or off-hook can be specified for memory entries.
- Mode change and pause data items can be stored in the dialing memories.
- 63-digit redial memory
- Automatic pause (3.9 seconds) insertion when the mode is switched.
- Automatic pause (1.0 second) insertion after a flash operation.
- Mode changing is one-directional, from pulse mode to tone mode.
- Output of a key press tone (1036 Hz, 31 ms) for keys other than DTMF keys when key input is valid
- Output of an operation complete confirmation tone (2072 Hz, 279 ms for each telephone number) when a telephone number is stored in memory
- Generates 12 signal types in DTMF mode.
- Supports an on-hook dialing mode.
- Supports a hold function with hold mode.
- Supports both 10 and 20 pps dialing pulse rates.
- The mode can be switched from either the P/T pin or by a key input.
- Settable dialing pulse circuit closed ratio (make percent): either 33% or 39%.
- Supports either keypad or serial input.
- Provides serial output of the keypad input data and the internal status.
- Capable of controlling the serial output timing.
- Supports 18 user-defined keys.
- Wide operating power-supply voltage range
 - Pulse mode: $V_{DD} = 1.5$ to 5.5 V
 - DTMF mode: $V_{DD} = 2.0$ to 5.5 V
- Low power operation
 - Pulse mode: $I_{DD} = 0.5$ mA max ($V_{DD} = 3.0$ V)
 - DTMF mode: $I_{DD} = 1.0$ mA max ($V_{DD} = 3.0$ V)
- Low standby current
 - $I_{DR} = 0.5$ μ A max ($V_{DD} = 1.0$ V)

Package Dimensions

unit: mm

3170-DIP36S

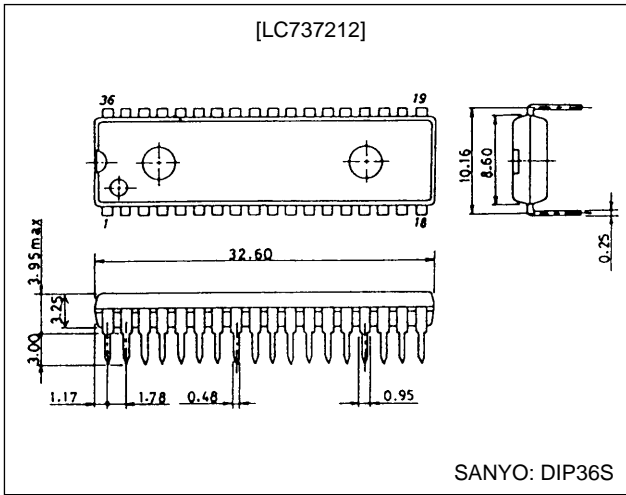

unit: mm

3129-MFP36SD

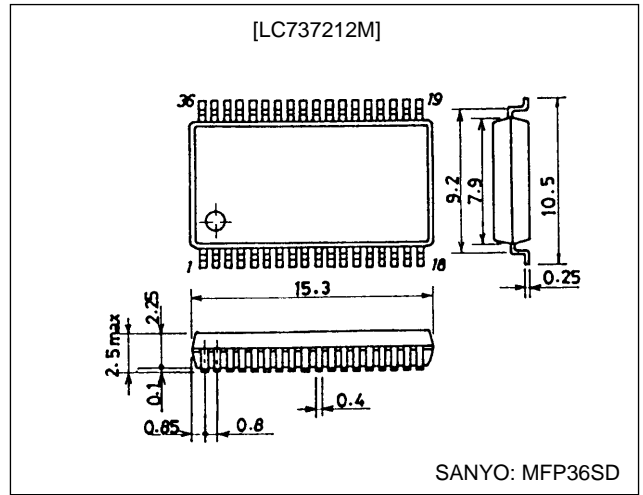

Specifications

Absolute Maximum Ratings at Ta = 25°C

Parameter	Symbol	Conditions	Ratings	Unit
Maximum power supply voltage	V _{DD} max		-0.3 to +6.5	V
Maximum input voltage	V _{IN} max		-0.3 to V _{DD} +0.3	V
Maximum output voltage	V _{OUT} max		-0.3 to V _{DD} +0.3	V
Allowable power dissipation	P _d max	Ta ≤ 70 °C	250	mW
Minimum load resistance	P _L min	Between the DTMF and V _{SS} pins	1	kΩ
Operating temperature	T _{opr}		-30 to +70	°C
Storage temperature	T _{stg}		-40 to +125	°C

Allowable Operating Ranges at Ta = 25°C

Parameter	Symbol	Conditions	min	typ	max	Unit
Supply voltage	V _{DDP}	Pulse mode	1.5		5.5	V
	V _{DDT}	DTMF mode	2.0		5.5	V
Input high-level voltage	V _{IH}	All input pins	0.7 V _{DD}		V _{DD}	V
Input low-level voltage	V _{IL}	All input pins	V _{SS}		0.3 V _{DD}	V
Key contact resistance	R _{KI}				3.0	kΩ
Keypad capacitance	C _{KI}				330	pF
Oscillator element rating	f	Center frequency = 3.579545 MHz	-1.3		+1.3	%
	R _S				100	Ω

LC737212, 737212M

Electrical Characteristics at Ta = 25°C, fosc = 3.579545 MHz

Parameter	Symbol	Conditions	min	typ	max	Unit
Operating current drain	I _{DDP}	Pulse output mode, outputs open, V _{DD} = 3.0 V		0.3	0.5	mA
	I _{DDT}	DTMF output mode, outputs open, V _{DD} = 3.0 V		0.5	1	mA
Static current drain	I _{DD(ST)}	Standby mode, outputs open, V _{DD} = 1.5 to 5.5 V			1	μA
Memory retention voltage	V _{DR}	Between V _{DD} and V _{SS}	1			V
Memory retention current	I _{DR}	V _{DD} = 1 V			0.5	μA
Input pin current	I _{IH1}	The SOUT-ENA, $\overline{\text{OFF-HOOK}}$, DPR, P/T, BMR, ON-HOOK-DIAL IN, HOLD-OFF IN, DISCON IN, SI/KEY, OFF/ON-HOOK, and STORE pins, V _{IH} = V _{DD}			1	μA
	I _{IL1}	The SOUT-ENA, $\overline{\text{OFF-HOOK}}$, DPR, P/T, BMR, ON-HOOK-DIAL IN, HOLD-OFF IN, DISCON IN, SI/KEY, OFF/ON-HOOK, and STORE pins, V _{IL} = V _{SS}	-1			μA
Key pin current	I _{ILK1}	All key pins, V _{DD} = 1.5 V, V _{ILK} = V _{SS}	-20			μA
	I _{ILK2}	All key pins, V _{DD} = 5.5 V, V _{ILK} = V _{SS}	-300			μA
	I _{OLK1}	All key pins, V _{DD} = 1.5 V, V _{OLK} = 0.4 V	200			μA
	I _{OLK2}	All key pins, V _{DD} = 5.5 V, V _{OLK} = 0.4 V	0.7			mA
Output pin leakage current	I _{OFF}	V _O = V _{DD} , V _{DD} = 5.5 V, with the output off, the DP, $\overline{\text{MUTE1}}$, $\overline{\text{MUTE2}}$, and S-OUT pins.			1	μA
Output pin voltage	V _{OH1}	The K-TONE, HOLD-OUT, HOOK-CTL, and SP-CTL pins, V _{DD} = 1.5 V, I _{OH} = -250 μA	V _{DD} - 0.5			V
	V _{OH2}	The K-TONE, HOLD-OUT, HOOK-CTL, and SP-CTL pins, V _{DD} = 5.5 V, I _{OH} = -1 mA	V _{DD} - 1			V
	V _{OL1}	The K-TONE, DP, $\overline{\text{MUTE1}}$, $\overline{\text{MUTE2}}$, SP-CTL, HOLD-OUT, and HOOK-CTL pins, V _{DD} = 1.5 V, I _{OL} = 250 μA			0.4	V
	V _{OL2}	The K-TONE, DP, $\overline{\text{MUTE1}}$, $\overline{\text{MUTE2}}$, SP-CTL, HOLD-OUT, and HOOK-CTL pins, V _{DD} = 5.5 V, I _{OL} = 1 mA			0.4	V

AC Characteristics at Ta = 25°C, fosc = 3.579545 MHz

Parameter	Symbol	Conditions	min	typ	max	Unit
Key debounce time	T _{KD}			30		ms
Pin chatter exclusion time	T _{PCHT}	$\overline{\text{OFF-HOOK}}$, P/T, ON-HOOK-DIAL, IN HOLD OFF IN		45		ms
Key scan frequency	f _{KSC}			258.9		HZ
Key tone frequency	f _{KT}			1035.7		HZ
Key tone output time	T _{KT}			30.9		ms
Auto-pause time	T _{AP}	In Pulse mode at 10 pps	3.88	3.9	3.93	s
		In Pulse mode at 20 pps	3.88	3.9	3.93	s
		DTMF mode	3.88	3.9	3.93	s
DTMF output time	T _{MFON}		98	100	102	ms
DTMF interdigit pause time	T _{MFOFF}		93	95	97	ms
Hooking time	T _{HK}		700	710	720	ms
Hooking pause time	T _{HKP}		0.98	1.0	1.02	s
Memory store confirmation tone frequency	f _{KST}			2071.4		Hz
Memory store confirmation tone output time	T _{KSTON}			278.1		ms
Low tone amplitude	V _{OR}	V _{DD} = 3.5 V, R _L = 10 kΩ	165	200	240	mVrms
Tone output ratio	dBCR	V _{DD} = 2.0 to 5.5 V, R _L = 10 kΩ	1	2	3	dB
Tone output distortion	DIS	V _{DD} = 2.0 to 5.5 V, R _L = 10 kΩ			10	%
Oscillator start time	T _{START}	V _{DD} = 1.5 to 5.5 V			30	ms
		V _{DD} = 3.0V		1		ms

LC737212, 737212M

Pulse Dialing Output/fosc = 3.579545 MHz

DPR pin	BMR pin	Dialing pulse rate	Interdigit pause	Make percent
V _{SS}	V _{DD}	9.94 pps	834.2 ms	33.2%
V _{DD}	V _{DD}	19.89 pps	525.2 ms	33.2%
V _{SS}	V _{SS}	9.94 pps	834.2 ms	39.2%
V _{DD}	V _{SS}	19.89 pps	525.2 ms	39.2%

DTMF Output/fosc = 3.579545 MHz

Input	Output frequency [Hz]		Deviation [%]
	Standard	LC737212	
R1	697	697.0	+0.01
R2	770	770.1	-0.02
R3	852	852.3	-0.03
R4	941	942.0	-0.11
C1	1209	1209.3	-0.03
C2	1336	1335.7	+0.03
C3	1477	1476.7	+0.02
C4	1633	1633.0	+0.00

Pin Assignment

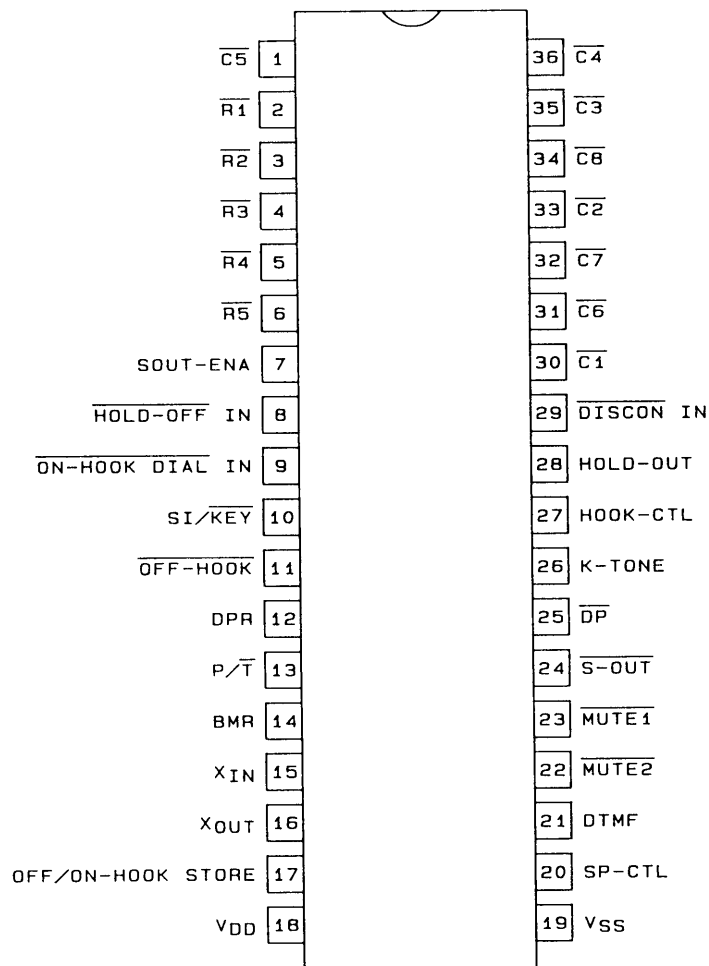

Top view

A04274

LC737212, 737212M

Block Diagram

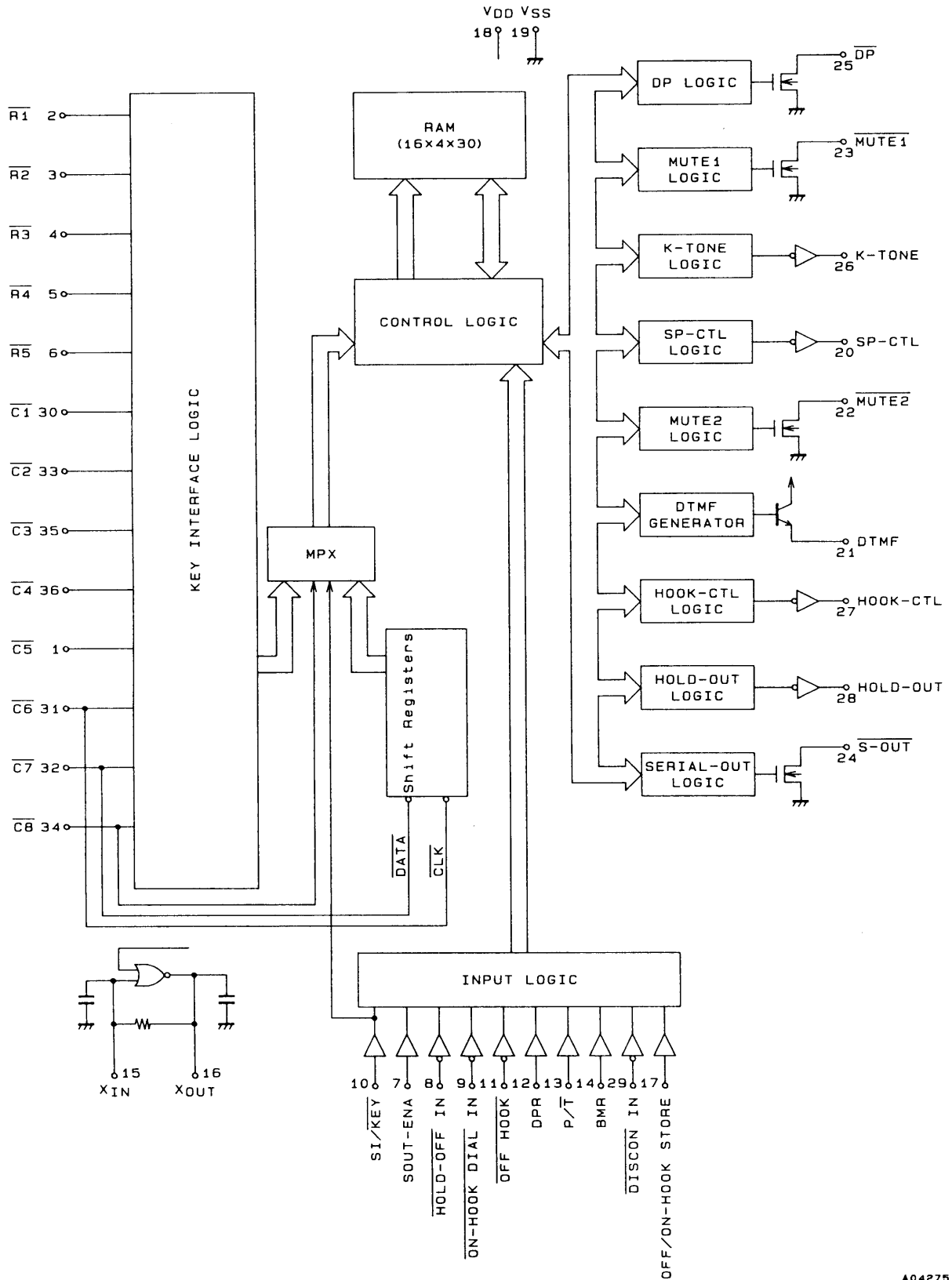

A04275

Keypad Layout

R1	1	2	3	F	00	05	10	15
	4	5	6	M	01	06	11	16
	7	8	9	R/P	02	07	12	17
to	*	0	#	HOLD ON/OFF	03	08	13	A4
R5	A1	A2	A3	STORE	04	09	14	A5
	$\overline{C1}$			to				$\overline{C8}$

Key Matrix Functions (when the SOUT-ENA pin is high)

- Digits 1 to 9, 0: Dialing data
- * and #: DTMF dialing data
In pulse mode, the * key switches the LC737212/M to DTMF mode.
- F: Flash (0.71 second)
- M: Quick-dialing address specification (only in the on-hook state, sets up memory store mode)
- R/P: Redial, pause (3.9 seconds), clear the paused state
- HOLD ON/OFF: Controls the on/off state of hold mode
- STORE: Sets up memory store mode.
- A1 to A5: One-touch dialing key
- 00 to 17: Definable function keys

The keypad is formed as a matrix using the key input pins ($\overline{R1}$ to $\overline{R5}$ and $\overline{C1}$ to $\overline{C8}$) and supports 40 keys. A given key is input by shorting or grounding the column pin and the row pin for that key. To prevent discharge of the backup battery due to inadvertent key presses in standby mode (when the circuit is disconnected from the telephone line), key input by shorting is not accepted. This means that if on-hook storing of telephone numbers in memory is selected, the application must implement STORE key (or M key) input by grounding the ROW pin and COLUMN pin.

- Digit keys (1 to 9 and 0)
 - Dialing data keys
 - Quick-dialing memory address specification keys
- * and # keys
 - DTMF mode: The * and # keys function as dial data keys
 - Pulse mode: * ... Pulse/tone switching key
... Unused.
- F key (flash key)

Invokes an operation equivalent to 0.71-second hooking implemented by turning on the DP output for 0.71 second. Although a 1-second pause is automatically inserted, the following dialing data may be entered during that period. Redialing is possible after a flash operation.
- M key (memory key)

When on-hook memory registration is set up, the system switches from standby mode to memory registration mode when the M key is pressed. The address of the dialing memory is specified by combination of the digit keys that are pressed immediately after the M key. The system operates as follows when the memory address operation is performed incorrectly.

Memory readout

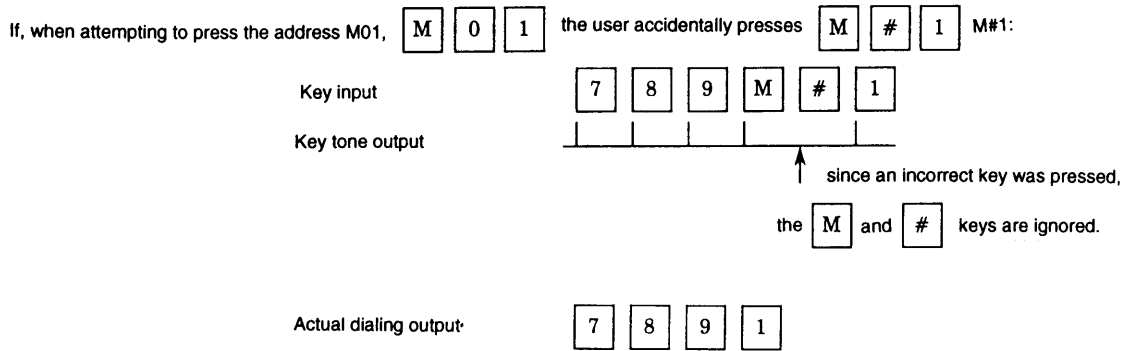

Memory store

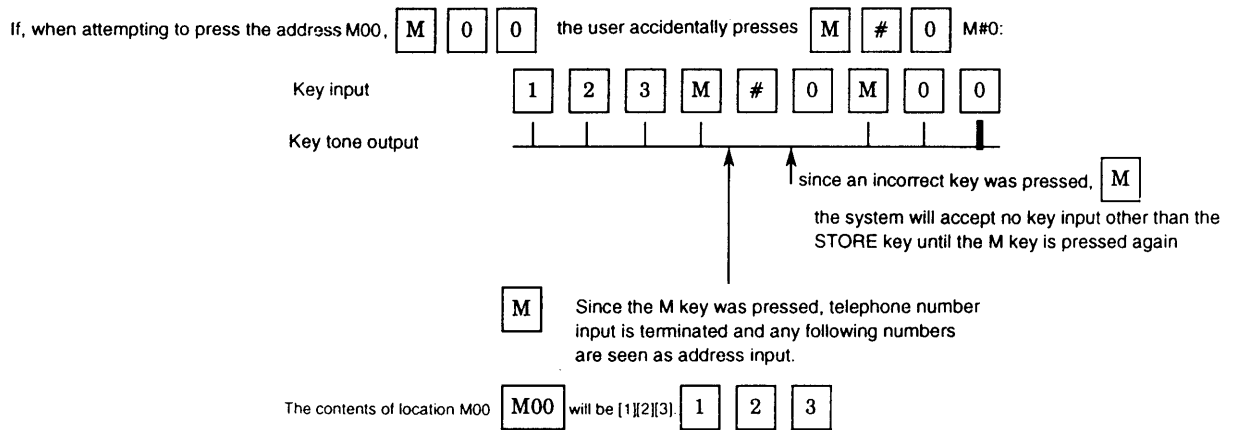

- R/P key

After connecting to the line, the R/P functions as a redial key as long as the system has not performed a dialing output operation. In manual dialing mode, the R/P key functions as the pause data key.

When dialing from memory:

 - During a pause operation: Cancels the pause
 - While dialing: Inserts a pause

During a redial operation:

 - During a pause operation: Cancels the pause
 - While dialing: Ignored

If two or more pause characters occur in the data, the pause cancel operation will cancel all pending pauses in a single operation.
- STORE key

Pressing the STORE key sets the system to memory store mode. Pressing the STORE key again during a memory store operation cancels all input data.
- HOLD ON/OFF key

Controls the on/off state of off-hook mode. No key tone is output at this time.
- Keys A1 to A5

These are the one-touch auto-dialing keys. Pressing one of these keys outputs the corresponding memory data from the DP and DTMF pins.
- Keys 00 to 17

These are user-defined keys. When one of these keys is pressed, the LC737212/M outputs the corresponding status and key code from the serial interface.

LC737212, 737212M

Pin Functions

Pin No.	Symbol	Function
1	$\overline{C5}$	Column input
2	$\overline{R1}$	Row input
3	$\overline{R2}$	
4	$\overline{R3}$	
5	$\overline{R4}$	
6	$\overline{R5}$	
7	SOUT-ENA	Serial output enable, H: enable, L: disable
8	$\overline{HOLD-OFF IN}$	Hold mode clear input; falling edge detection.
9	$\overline{ON-HOOK DIAL IN}$	On-hook dialing input; falling edge detection
10	$\overline{SI/KEY}$	Serial input/keypad input switching
11	$\overline{ON-HOOK}$	Hook-switching input
12	DPR	Dialing pulse rate switching; H: 20 pps, L: 10 pps
13	$\overline{R/T}$	Pulse/tone switching; H:pulse, L: tone
14	BMR	Make percentage switching input; H: 33%, L: 39%
15	XIN	Oscillator circuit. Connect either a crystal or ceramic oscillator element with a frequency of 3.58 MHz between these pins.
16	XOUT	
17	OFF/ON-HOOK STORE	Off-hook store/on-hook store switching
18	V_{DD}	Power supply
19	V_{SS}	
20	SP-CTL	Speaker reception control output; complementary output
21	DTMF	DTMF output; npn emitter-follower output
22	$\overline{MUTE2}$	DTMF mute output; n-channel open drain output
23	$\overline{MUTE1}$	DP and K-TONE muting output; n-channel open drain output
24	$\overline{S-OUT}$	Serial data output; n-channel open drain output
25	\overline{DP}	Dialing pulse output; n-channel open drain output
26	K-TONE	K-tone output; complementary output
27	HOOK-CTL	Hook control output; complementary output
28	HOLD-OUT	Hold mode output; complementary output
29	$\overline{DISCON IN}$	Disconnect input
30	$\overline{C1}$	Column inputs
31	$\overline{C6}$	
32	$\overline{C7}$	
33	$\overline{C2}$	
34	$\overline{C8}$	
35	$\overline{C3}$	
36	$\overline{C4}$	

• SOUT-ENA

Normally set high. Serial output and Dial output are enabled when this pin is set high.

• $\overline{\text{HOLD OFF IN}}$

Hold mode is cleared when a falling edge is detected on this pin. HOLD-OFF pin inputs are not accepted for the 0.5 seconds immediately following a transition to on-hook hold mode.

• $\overline{\text{ON-HOOK-DIAL IN}}$

This pin toggles an on/off state on each input falling edge. When the telephone is on hook, this pin toggles the on/off state of on-hook dialing mode. When the telephone is off hook, this pin toggles the on/off state of monitor mode.

• $\overline{\text{SI/KEY}}$

The keypad is set to input mode when this pin is set low. When this pin is set high, serial input is enabled. In this state, all keypad inputs are pulled up by built-in resistors, and the pins $\overline{\text{C6}}$ to $\overline{\text{C8}}$ function as the serial interface input pins.

$\overline{\text{C6}}$ = serial clock input

$\overline{\text{C7}}$ = serial data input

$\overline{\text{C8}}$ = strobe input

• $\overline{\text{OFF-HOOK}}$

This pin is the hook state switching input.

• DPR

This pin is the dialing pulse rate switching input. (H: 20 pps, L: 10 pps)

• $\overline{\text{P/T}}$

This pin is the dialing signal switching input. (H: pulse, L: DTMF) This pin can only switch from pulse to DTMF. This allows mixed-mode dialing, i.e. switching modes during dialing.

• DISCON IN

Setting this pin low switches the LC737212/M to low power mode and forcibly stops the oscillator circuit. All outputs are turned off in low power mode. (The n-channel open-drain outputs go to the high-impedance state, and the complementary outputs go low.) The internal states of the LC737212/M are reset when this pin goes high.

Off-hook input	On-hook Dial input	Status
H	H	STANDBY
H	L	ON-HOOK DIAL
L	H	OFF-HOOK DIAL
L	L	MONITOR

We recommend setting the DISCON pin low when power is first applied, and setting it high after the power-supply voltage (V_{DD}) has reached or exceeded 1.5 volts.

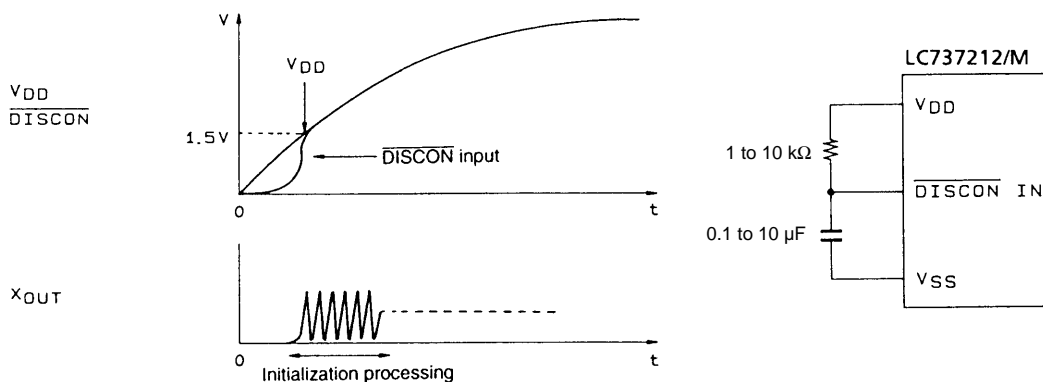

A04276

• BMR

This pin sets the break/make ratio for the dialing pulse output. (H: 33.2%, L: 39.2%)

• OFF/ON-HOOK STORE

This pin switches the memory storing mode.

H: Off-hook store (Memory stored with the telephone line connected.)

L: On-hook store (Memory stored with the telephone line disconnected.)

- **SP-CTL**
This pin provides the speaker reception control output. This output is set on during the on-hook dialing, monitor, and hold states. This is a complementary output.
- **DTMF**
The DTMF output pin. This is an npn emitter-follower output.
- **MUTE2**
The DTMF muting output. This output is turned on in synchronization with the DTMF output. This is an n-channel open-drain output. The wired OR with the $\overline{\text{MUTE1}}$ output can be taken.
- **MUTE1**
The DP and K-TONE muting output. This output is turned on in synchronization with the dialing pulse and K-TONE outputs. This is an n-channel open-drain output. The wired OR with the $\overline{\text{MUTE2}}$ output can be taken.
- **S-OUT**
The serial data output. This pin is used to output the internal status of the LC737212/M and the keypad data. This is an n-channel open-drain output.
- **$\overline{\text{DP}}$**
The dialing pulse output. This is an n-channel open-drain output.
- **K-TONE**
This pin outputs the key input confirmation tone (1036 Hz, 31 ms) and the memory store confirmation tone (2073 Hz, 279 ms). This is a complementary output.
- **HOOK-CTL**
The circuit control output. A high level is output when the circuit is connected. This is a complementary output.
- **HOLD-OUT**
The hold control output. A high level is output during a hold. This is a complementary output.
- **XIN and XOUT**
The oscillator connection pins. Connect a 3.579545-MHz oscillator element. No other external components are required if a crystal oscillator element with built-in feedback resistor and capacitor components is used. Two 30-pF capacitors are required if a ceramic resonator is used.
- **R1 to R5 and C1 to C8**
The keypad connections.
- **V_{DD} and V_{SS}**
The power supply connections.

LC737212, 737212M

Pin Internal Circuit

Pin No.	Pin	Internal equivalent circuit
1 to 6 30 to 36	$\overline{R1}$ to $\overline{R5}$ $\overline{C1}$ to $\overline{C8}$	<p style="text-align: right;">A04277</p>
7 to 14 17 29	SOUT-ENA HOLDOFF IN ON-HOOKDIAL IN SI/KEY OFF-HOOK DPR P/ \overline{T} BMR OF/ON-HOOK STORE DISCON IN	<p style="text-align: right;">A04278</p>
15	X_{IN}	<p style="text-align: right;">A04279</p>
16	X_{OUT}	
22 to 25	$\overline{MUTE2}$ $\overline{MUTE1}$ S-OUT DP	<p style="text-align: right;">A04280</p>
20 26 to 28	SP-CTL K-TINE HOOK-CTL HOLD-OUT	<p style="text-align: right;">A04281</p>
21	DTMF	<p style="text-align: right;">A04282</p>

Key Operations

↓: On hook ↑: Off hook
 □_{Dn}: Key input
 Dn: Pulse output Ḋ_n: Tone output

Item		Key Input	Dialing Output
Normal dialing (pulse mode)		↑ □ _{D1} , □ _{D2} □ _{Dn}	D ₁ , D ₂ D _n
Normal dialing using the □ _{R/P} key (pulse mode)		↑ □ _{D1} , □ _{D2} , □ _{R/P} , □ _{D3}	D ₁ , D ₂ $\xrightarrow{3.9\text{ s}}$ D ₃
Normal dialing and redialing (pulse mode)	Normal	↑ □ _{D1} , □ _{D2} □ _{Dn}	D ₁ , D ₂ D _n
	Redialing	↓ ↑ □ _{R/P}	D ₁ , D ₂ D _n
Normal dialing including mode changes (pulse mode at the start of the operation)	Using keys	↑ □ _{D1} , *, □ _{D2} , □ _{D3}	D ₁ , $\xrightarrow{3.9\text{ s}}$ Ḋ ₂ , Ḋ ₃
	Using the P/T switch	↑ □ _{D1} , (P/T↓), □ _{D2} , □ _{D3}	D ₁ , $\xrightarrow{3.9\text{ s}}$ Ḋ ₂ , Ḋ ₃
Memory store and readout	Quick dialing	Store (pulse mode)	↓ □ _{STO} □ _{D1} □ _{D2} □ _{D3} □ _M □ _{D4} □ _{D5}
		Readout	↑ □ _M □ _{D4} □ _{D5}
	One-touch dialing	Store (tone mode)	↓ □ _{STO} □ _{D1} □ _{D2} □ _{D3} □ _{A1}
		Readout	↑ □ _{A1}

Timing Charts

Pulse dialing

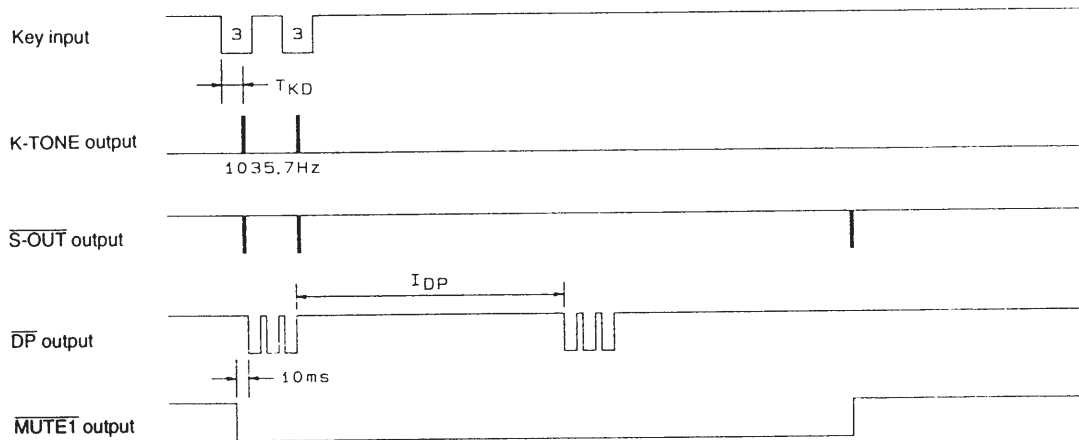

A04283

DTMF dialing

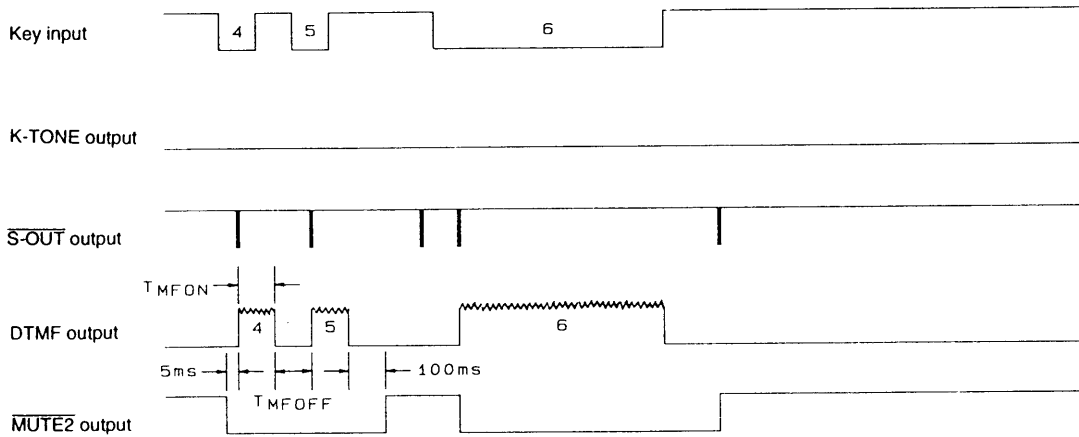

A04284

Flash operation

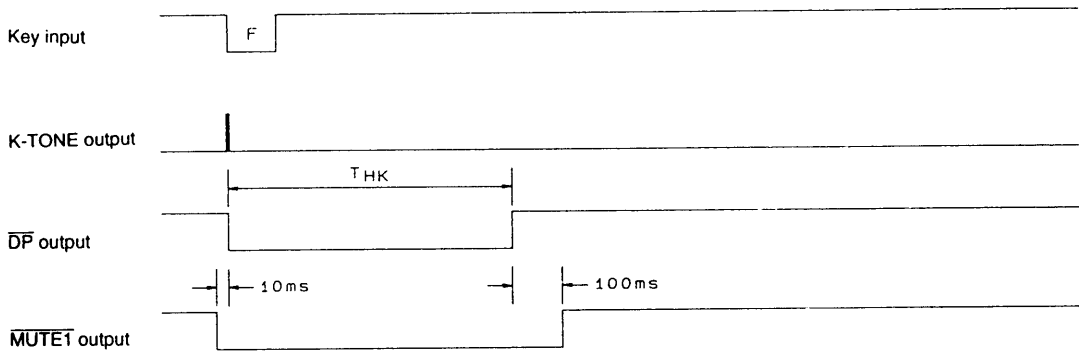

A04285

Pulse/tone mixed dialing

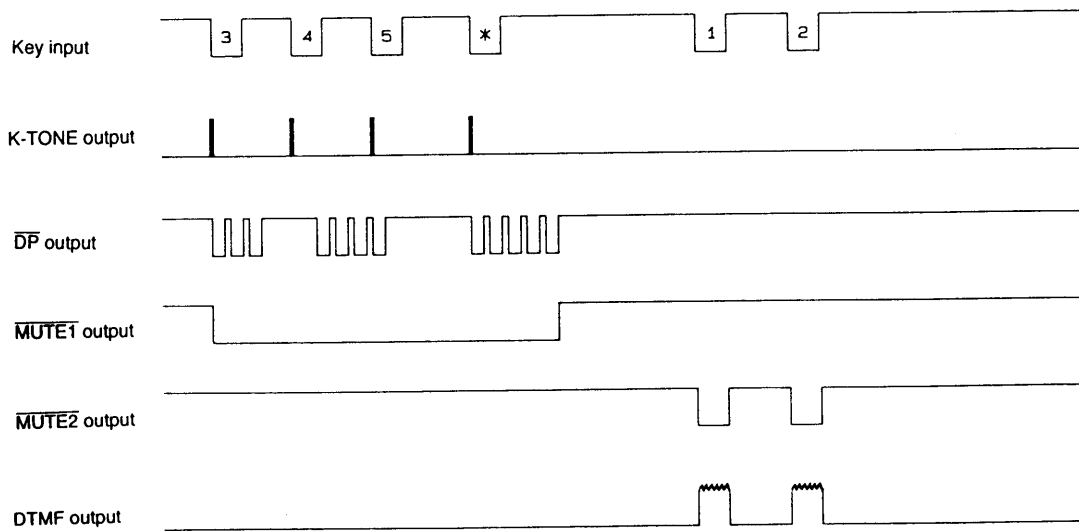

A04286

After the pulse dialing (including IDP) has completed, when DTMF key input operations are performed, DTMF signals are output continuously while keys are pressed.

Pulse/Tone Mixed Dialing (using automatic pausing)

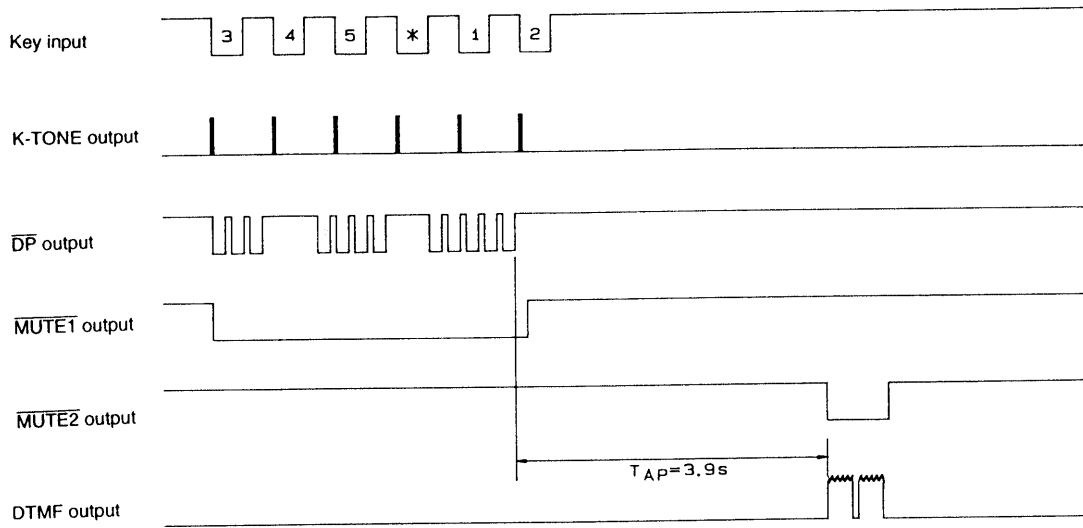

A04287

If a DTMF key operation is performed during dialing pulse output (including IDP), the K-TONE signal will be output continuously while keys are pressed. Then, after the pulse dialing completes, the LC737212/M will pause for 3.9 seconds and then output the DTMF signals.

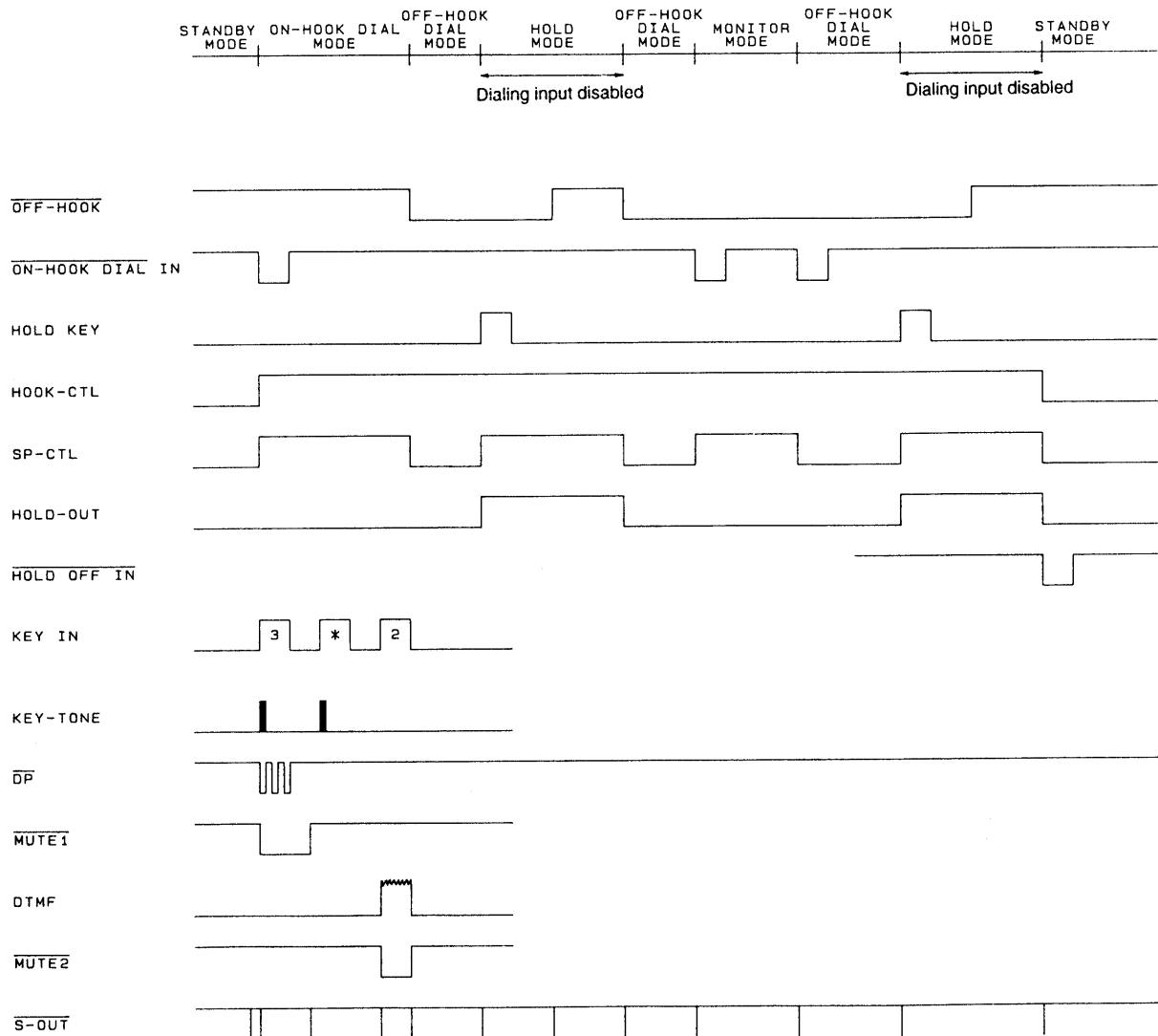

A04288

LC737212 and LC737212M Operating Specifications

1. IC Internal Status

The LC737212 and LC737212M have 14 internal states. Table 1 presents a functional overview of these states. The individual status bits have the following interpretations.

- D4: SP-CTL output
- D3: HOOK-SW information
- D2: Memory store
- D1: Hold (the HOLDOUT output)
- D0: Dialing allowed.

However, note that during standby key acquisition, D1 and D2 do not have the above meanings.

Table.1 State Table

No.	State	HOOK-SW	Function	HOOK-CTL	SP-CTL	HOLD-OUT	Dialing output	Status bits D4 to D0	Notes
1	Standby	ON	Key input by shorting key pins disabled.	OFF	OFF	OFF	Disabled	01000	
2	Standby with key acquisition	ON	Keypad input enabled. Only the keypad data is output through the serial interface.	OFF	OFF	OFF	Disabled	01110	Switched to from standby mode.
3	Off-hook dialing	OFF	Off-hook dialing mode	ON	OFF	OFF	Disabled	00001	
4	Off-hook dialing with key acquisition	OFF	Only the keypad data is output through the serial interface. Data is not written to the redial memory.	ON	OFF	OFF	Disabled	00000	Switched to from off-hook dialing mode.
5	On-hook dialing	ON	On-hook dialing mode	ON	ON	OFF	Enabled	11001	
6	On-hook dialing with key acquisition	ON	Only the keypad data is output through the serial interface. Data is not written to the redial memory.	ON	ON	OFF	Disabled	11000	Switched to from off-hook dialing mode.
7	Monitor	OFF	Monitor mode	ON	ON	OFF	Enabled	10001	
8	Monitor with key acquisition	OFF	Only the keypad data is output through the serial interface. Data is not written to the redial memory.	ON	ON	OFF	Disabled	10000	Switched to from monitor mode.
9	Off-hook hold	OFF	Hold mode	ON	ON	ON	Disabled	10010	Switched to from off-hook dialing mode.
10	On-hook hold	ON	Hold mode	ON	ON	ON	Disabled	11010	Switched to from on-hook hold mode.
11	On-hook store	ON	Memory store more (circuit disconnected)	OFF	OFF	OFF	Disabled	01100	Switched to from standby mode.
12	Off-hook store	OFF	Memory store more (circuit connected)	ON	ON	OFF	Disabled	00100	Switched to from off-hook dialing mode.
13	Off-hook dialing and store	ON	Memory store more (circuit connected)	ON	ON	OFF	Disabled	11100	Switched to from off-hook dialing mode.
14	Monitor store	OFF	Memory store more (circuit connected)	ON	ON	OFF	Disabled	10100	Switched to from monitor mode.

2. Dialing Output Specifications

Dialing output is possible in the off-hook dialing, on-hook dialing, and monitor modes.

The output pulse make percentage in pulse mode can be specified to be 33.2 or 39.3% with the BMR pin.

The output pulse rate in pulse mode can be set to be 10 or 20 pps with the DPR pin.

The LC737212 can generate 12 DTMF dialing signals in DTMF mode. (If serial input is used, it can generate 16 DTMF dialing signals.)

DTMF signals are output continuously as long as the corresponding key is held down.

The LC737212 guarantees a minimum DTMF output time of about 100 ms, and also guarantees a minimum IDP of about 100 ms.

If the mode is changed (with the $\overline{P/T}$ pin or * key) during a pulse dialing operation and then DTMF data is keyed in, the system automatically inserts a 3.9 second pause after completing the pulse dialing sequence and then outputs the DTMF signals.

If the mode is changed after a pulse dialing operation and DTMF data is keyed in, the system does not automatically insert a pause, but rather outputs the DTMF data as it is keyed in.

The pause key (the R/P key used as the second or later digit) can be used to enter pause data.

If pause data and mode change data (MC) are entered consecutively, the system pauses for 3.9 seconds.

After connecting to the line, the first time the R/P key is pressed, the system will redial the previously entered dialing data.

3. Memory Output Specifications

The LC737212/M provides five 16-digit memory locations for one touch dialing memory, 20 16-digit memory locations for quick-dialing memory, a 16-digit buffer memory for store operations, and a 63-digit redialing memory. A single digit of memory can hold a single dialing data item (1 to 9, 0, *, or #), a single mode change data item (MC), or a single pause data item (P).

- RD memory

The LC737212/M includes a 63-digit buffer memory that also functions as the redial memory, and thus is called the RD memory. The keyed in input data is stored sequentially in the RD memory.

- Dialing data stored in RD memory is read out at the specified dialing rate and output from the DP or DTMF pin.

- Dialing numbers that exceed 63 digits is possible. The system writes the key data that exceeds 63 digits starting at the beginning (location 0) of RD memory and outputs that data.

- However, this means that redialing numbers that exceed 63 digits is not possible since the dialing data is not all correctly retained in RD memory.

- Dialing memory (one-touch dialing and quick dialing)

- LC737212 provides five locations (A1 to A5) for one-touch dialing, and 20 locations (M00 to M19) for quick dialing.

- Each of these dialing memory locations holds 16 digits of dialing data plus the output format (pulse or DTMF) for the start of the data.

- When a dialing memory location is accessed, its content is copied to RD memory and then the LC737212/M dials that number by reading it out of RD memory.

- If a number stored as DTMF in dialing memory is read out after a pulse dialing operation, a mode change (MC) data item is automatically inserted in RD memory.

- After a DTMF signal is output, if data registered as pulse data is read out from a dialing memory, that data will be output as DTMF signals.

- Data store buffer memory

- This memory is used when storing a number in dialing memory.

4. Off-Hook Hold and On-Hook Hold Modes

Pressing the HOLD key switches between off-hook dialing mode and hold (off-hook hold mode).

In hold mode, the HOLD-OUT and SP-CTL outputs are turned on.

Dialing is disabled in hold mode.

It is not possible to hold during dialing.

Placing the phone on hook switches the system from off-hook hold mode to on-hook hold mode.

Lifting the receiver switches the system from on-hook hold mode to off-hook hold mode.

Hold is cleared by a falling edge on the $\overline{\text{HOLD-OFF IN}}$ pin.

- This switches from off-hook hold mode to on-hook dialing mode.

- This also switches from on-hook hold mode to standby mode.

After switching to off-hook hold mode, falling edges on the $\overline{\text{HOLD-OFF IN}}$ pin are not detected for 0.5 second.

5. On-Hook Dialing

Falling edges on the $\overline{\text{ON-HOOK DIAL IN}}$ input switches the system between standby mode and on-hook dialing mode.

In on-hook dialing mode, the HOOK-CTL and SP-CTL pins output high levels.

It is not possible to hold when the system is in on-hook dialing mode.

Lifting the receiver switches the system to off-hook dialing mode.

6. Monitor Mode

Falling edges on the $\overline{\text{ON-HOOK DIAL IN}}$ input switches the system between off-hook dialing mode and monitor mode.

In monitor mode, the HOOK-CTL and SP-CTL pins output high levels.

It is not possible to hold when the system is in monitor mode. • Placing the receiver on-hook switches the system to on-hook dialing mode.

7. Memory Store Function

On-hook (with the line disconnected) and off-hook (with the line connected, including on-hook dialing and monitor modes) storing can be selected. The On/OFF-HOOK store pin is used for this selection.

Data is stored in memory in store mode. The following key sequences switch the system to store mode.

- On-hook (disconnected from the line) ... Pressing either the STORE or M key
- Off-hook (connected to the line) ... Pressing the STORE key

Data is written to a memory store buffer memory (16 digits) by keying in that dialing data. Key confirmation tones (1036 Hz, 31 ms) are output from the K-TONE pin during this operation. Keyed data corresponding to a seventeenth or later digit is ignored and the confirmation tone is not output for those digits.

Specifying the memory address copies the contents of the memory store buffer memory to the specified address and completes the memory store operation. A memory store confirmation tone (2072 Hz, 279 ms) is output from the K-TONE pin at this point.

The data at a given address can be deleted by switching to store mode and then specifying the address without entering any dialing data.

8. Key Acquisition Modes

In these modes, the LC737212/M simply accepts key input and transmits the corresponding key code and status over the serial interface. Data from the keypad is not written to the RD memory and dialing is not performed.

- Standby key acquisition mode
 - Pressing the 00 key when the SI/KEY pin is low, or entering a code value of 20 when the SI/KEY pin is high, switches the LC737212/M between standby mode and standby key acquisition mode.
 - If, and only if, on-hook memory storing is selected, pressing the STORE key will switch the system to on-hook store mode.
- Off-hook key acquisition mode, on-hook dialing key acquisition mode, and monitor key acquisition mode
 - In modes that allow dial output, entering a code value of 20 over the serial interface will switch the LC737212/M to the corresponding key acquisition mode.
 - Even if the LC737212/M is in a key acquisition mode, dialing data entered over the serial interface will be dialed.

9. Serial Output

During key input and when the system's internal mode change, the LC737212/M outputs the corresponding status data from the $\overline{\text{S-OUT}}$ pin. Values of 0 and 1 are expressed by the length of the period the n-channel open-drain output pin is in the on state, and data is grouped in 4-bit units for output.

0 = 280 μs , 1 = 760 μs , inter-bit interval = 560 μs

Interval between 4-bit groups = 1440 μs

(In memory content readout mode only, the 4-bit group interval is 1520 μs .)

- During Key Input
 - This data consists of 16 bits, starting with a bit (always 0) that indicates that this data is key input data. The next 2 bits are dialing related data, then the next 5 bits indicated the LC737212/M internal status, and finally, the last 8 bits indicate the key data.
 - The data for all key presses that were longer than 30 ms (the key bounce (chatter) exclusion time) are output. (For example, data key presses when the system is in hold mode are not dialed, but are output from S-OUT as key data.)

LC737212, 737212M

* Timing chart · Assuming the 3 key was pressed in normal mode.

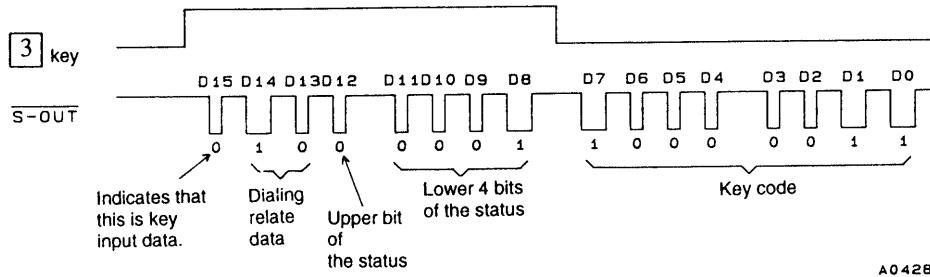

D15 D14 D13 D12	Indicates that this is for key input. Always 0 Indicates the key data write type. Pulse = 1, DTMF = 0 Indicates dialing output. Output in progress = 1, output done = 0. Upper bit of the IC internal status
D11 D10 D9 D8	Lower four bits of the IC internal status.
D7 D6 D5 D4	Key code KCU
D3 D2 D1 D0	Key code KCL

LC737212, 737212M

Key Codes

KEY			KEY CODE								HEX	
KEY	ROW	COL	D7	D6	D5	D4	D3	D2	D1	D0		
1	1	1	1	0	0	0	0	0	0	1	8	1
2	1	2	1	0	0	0	0	0	1	0	8	2
3	1	3	1	0	0	0	0	0	1	1	8	3
4	2	1	1	0	0	0	0	1	0	0	8	4
5	2	2	1	0	0	0	0	1	0	1	8	5
6	2	3	1	0	0	0	0	1	1	0	8	6
7	3	1	1	0	0	0	0	1	1	1	8	7
8	3	2	1	0	0	0	1	0	0	0	8	8
9	3	3	1	0	0	0	1	0	0	1	8	9
0	4	2	1	0	0	0	1	0	1	0	8	A
*/T	4	1	1	0	0	1	1	0	1	1	9	B
#	4	3	1	0	0	1	1	1	0	0	9	C
F	1	4	0	1	0	0	0	0	1	1	4	3
M	2	4	0	1	0	0	0	1	0	1	4	5
HOLD	4	4	0	1	0	0	0	1	1	1	4	7
STORE	5	4	0	1	0	0	1	0	0	1	4	9
R/P	3	4	0	1	1	0	1	0	0	1	6	9

Key Codes

KEY			KEY CODE								HEX	
KEY	ROW	COL	D7	D6	D5	D4	D3	D2	D1	D0		
00	1	5	0	0	0	0	0	0	0	0	0	0
01	2	5	0	0	0	0	0	0	0	1	0	1
02	3	5	0	0	0	0	0	0	1	0	0	2
03	4	5	0	0	0	0	0	0	1	1	0	3
04	5	5	0	0	0	0	0	1	0	0	0	4
05	1	6	0	0	0	0	0	1	0	1	0	5
06	2	6	0	0	0	0	0	1	1	0	0	6
07	3	6	0	0	0	0	0	1	1	1	0	7
08	4	6	0	0	0	0	1	0	0	0	0	8
09	5	6	0	0	0	0	1	0	0	1	0	9
10	1	7	0	0	0	1	0	0	0	0	1	0
11	2	7	0	0	0	1	0	0	0	1	1	1
12	3	7	0	0	0	1	1	0	1	0	1	2
13	4	7	0	0	0	1	0	0	1	1	1	3
14	5	7	0	0	0	1	0	1	0	0	1	4
15	1	8	0	0	0	1	0	1	0	1	1	5
16	2	8	0	0	0	1	0	1	1	0	1	6
17	3	8	0	0	0	1	0	1	1	1	1	7
A1	5	1	0	0	1	1	0	0	0	1	3	1
A2	5	2	0	0	1	1	0	0	1	0	3	2
A3	5	3	0	0	1	1	0	0	1	1	3	3
A4	4	8	0	0	1	1	0	1	0	0	3	4
A5	5	8	0	0	1	1	0	1	0	1	3	5

• Mode change (when the IC internal state changes)

— Here the data consists of eight bits, one bit (which is always 1) used to differentiate this data from key data, and seven bits expressing the mode change. This data is output when the internal state changes, the P/T pin changes, or when dialing completes.

— D5 expresses the state of the P/T pin.

1 = pulses, 0 = DTMF

In the following cases, the status is not output even if the P/T pin changes state.

In standby mode, off-hook hold mode, or on-hook hold mode.

After tone data (including MC) is written to RD memory.

— When a memory location that does not have data stored is accessed:

If not dialing: the status when dialing completed is output as serial data.

If dialing: A serial output operation is not performed.

— If a redial operation is attempted when redial is disabled (when the last number dialed exceeded 63 digits) the status when dialing completed is output as serial data.

* Timing Chart

· From the standby state to off hook, and then to off-hook dialing

· With the P/T switch set to P

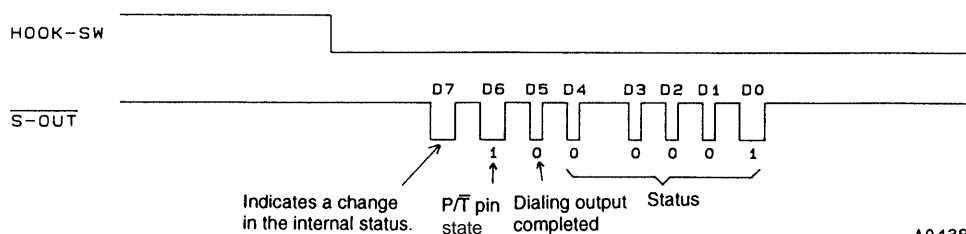

A0 4290

10. Serial Input

The following control can be performed using serial input.

Keypad input replacement (except for user-defined keys)

Setting the status bits (e.g., setting the on-hook dialing mode on/off)

Reading out the content of dialing memory

Setting the output port on/off states (including the DTMF signal output)

• Serial input format

— Set the $\overline{SI/KEY}$ input pin high. This causes all the keypad inputs to be pulled up and the $\overline{C6}$ to $\overline{C8}$ pins function as serial input pins for an internal shift register.

$\overline{C6}$ = Clock input

$\overline{C7}$ = Data input

$\overline{C8}$ = Strobe input

— Data is written on the falling edge of the clock input

— The period when the strobe input is low is equivalent to the period when a keypad key is pressed.

— The data consists of 8 bits.

— Codes other than the 40 codes defined as keypad keys are defined as input data codes in the serial input.

— This allows controls other than the DPR and BMR controls to be input serially.

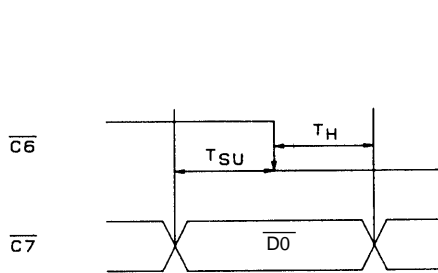
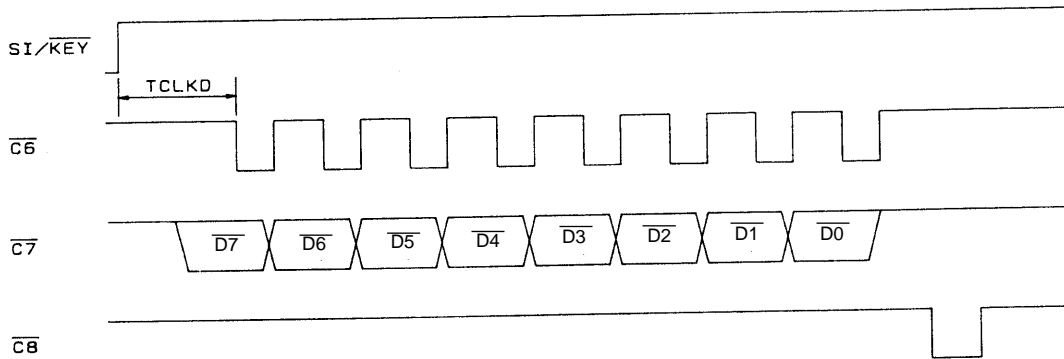

- T_{SU} : SET UP TIME > 1 μ s
- T_H : HOLD TIME > 1 μ s
- TCLKD: CLK DELAY TIME > 35 ms
- T_{STW} : STROBE WIDTH TIME > 35 ms
- T_{STP} : STROBE PERIOD TIME > 40 ms
- When a readout of dialing memory is in progress:
 - T_{STW} > 120 ms
 - T_{STP} > 125 ms

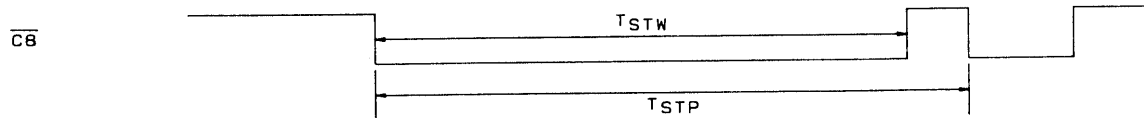

A04291

Serial Input Code Table

Serial code (HEX)	Command	Function or operation
00		Serial readout of quick-dialing memory locations 00 to 09
01		
02		
03		
04		
05		
06		
07		
08		
09		
0A		Serial readout of one-touch memory locations A1 to A5
0B		
0C		
0D		
0E		
0F		Serial readout of the buffer memory used for storing to memory
10		Serial readout of quick-dialing memory locations 10 to 19
11		
12		
13		
14		
15		
16		
17		
18		
19		
1A		Undefined
1B		
1C		Serial readout of redial memory 1C: digits 1 to 16 1D: Digits 17 to 32 1E: digits 33 to 48 1F digits 49 to 63
1D		
1E		
1F		
20		Key acquisition mode on/off setting
21 to 2F		Undefined
30		The same function as the A1 one-touch dialing key.
31	A1	The same functions as the one-touch dialing keys A1 to A5
32	A2	
33	A3	
34	A4	
35	A5	
36 to 3E		The same function as the A1 one-touch dialing key
3F		Cancels a memory store operation if one is in progress. Otherwise identical to the A1 key.
40 to 42		Undefined
43	F	Identical to the F1 key.
44	RD	Cancels redial or pause operations.
45	M	Identical to the M key.
46	CLR	Clears all memories. This function is enabled in memory store mode.
47	HOLD	Identical to the HOLD key.
48		Undefined
49	STORE	Identical to the STORE key.
4A	OHD-ON	On-hook dial and monitor mode setting (OHD-ON)
4B to 4C		Undefined
4D	RDINH	Disables redial.

Continued on next page.

LC737212, 737212M

Continued from preceding page.

Serial Code (HEX)	Command	Function or operation
4E		DTMF output off
4F	DISCON	Initial settings (DISCON)
50 to 5F		Undefined
60 to 6F	R/P	Identical to the R/P key.
70 to 7F		Undefined
80		Undefined
81	1	Identical to the dial data keys 1 to 8.
82	2	
83	3	
84	4	
85	5	
86	6	
87	7	
88	8	
89	9	Identical to the dial data keys 9 and 0.
8A	0	
8B, 8C		Illegal value
8D		Pause data
8E		Undefined
8F		Illegal value
90		Undefined
91 to 9A		Illegal in pulse mode. Dialing data when the IC is in tone mode.
9B	*	Identical to the dial data key "*".
9C	#	Identical to the dial data key "#".
9D		Illegal in pulse mode. Pause data when the IC is in tone mode.
9E		Undefined
9F		Illegal value
A0, A1		Undefined
A2	MC	Converts input data from pulse to DTMF. Illegal in tone mode.
A3 to AF	P1/DFIN	Undefined
B0 to BF	P2	Undefined
C0 to CF		Undefined
D0		Outputs the DTMF signal for 1
D1		Outputs the DTMF signal for 4
D2		Outputs the DTMF signal for 7
D3		Outputs the DTMF signal for *
D4		Outputs the DTMF signal for 2
D5		Outputs the DTMF signal for 5
D6		Outputs the DTMF signal for 8
D7		Outputs the DTMF signal for 0
D8		Outputs the DTMF signal for 3
D9	LCHN	Left channel N output
DA	LV _{SS}	Left channel ground. Normally 0 V.
DB		Outputs the DTMF signal for #
DC		Outputs the DTMF signal for A
DD		Outputs the DTMF signal for B
DE		Outputs the DTMF signal for C
DF		Outputs the DTMF signal for D
E0		Sets the S-OUT output off
E1		Sets the S-OUT output on
E2		Sets the HOLD output off
E3		Sets the HOLD output on
E4		Sets the HK-CTL output off

Continued on next page.

LC737212, 737212M

Continued from preceding page.

Serial code (HEX)	Command	Function or operation
E5		Sets the HK-CTL output on
E6		Turns on the K-TONE 2-kHz frequency for 279 ms
E7		Turns on the K-TONE 1-kHz frequency for 31 ms
E8		Sets the SP-CTL output off
E9		Sets the SP-CTL output on
EA		Sets the MUTE2 output off
EB		Sets the MUTE2 output on
EC		Sets the MUTE1 output off
ED		Sets the MUTE1 output on
EE		Sets the DP output off
EF		Sets the DP output on
F0 to FF	SREQ	Reads out the status data serially (SREQ)

Note: The undefined command codes are ignored.

- Functions unique to the serial input commands

- When the $\overline{SI/KEY}$ pin is high, inputting code values 00 to 19 or 1C to 1F serially causes the contents of the corresponding dialing memory to be output from the $\overline{S-OUT}$ pin.
- All data is grouped into four-bit groups and output. After first outputting the output format (pulse = 1111, DTMF = 1110), the LC737212/M outputs the dial data. The data value 0000 indicates that output has completed.
- See item (9) concerning serial output on page 17 for details on the output format for the data from the $\overline{S-OUT}$ pin.
- RD memory data (63 digits) is read out 16 digits at a time in four operations.
- When redial memory is disabled, attempts to read out RD memory (1C) serially will result in the output of either F0 or E0.

Data in dialing memory is represented as shown in the table.

Dialing Data	Representation in RAM	Dialing Data	Representation in RAM
1	0001	9	1001
2	0010	0	1010
3	0011	*	1011
4	0100	#	1100
5	0101	Pause	1101
6	0110	MC (P → C)	1110
7	0111	Data end	000
8	1000		

Switching Output Ports On and Off

- When the $\overline{SI/KEY}$ pin is high, inputting the following code values serially sets the corresponding output port on or off. Since these commands directly write to the output port data latch, they do not change the internal status, memory or other aspects.

$\overline{S-OUT}$	ON (E1)	OFF (E0)
HOLD	ON (E3)	OFF (E2)
HK-CTL	ON (E5)	OFF (E4)
K-TONE	1 kHz (E7)	2 kHz (E6)
SP-CTL	ON (E9)	OFF (E8)
$\overline{MUTE2}$	ON (EB)	OFF (EA)
$\overline{MUTE1}$	ON (ED)	OFF (EC)
\overline{DP}	ON (EF)	OFF (EE)

When the K-TONE output is turned on, the $\overline{\text{MUTE1}}$ output will operate in synchronization with the K-TONE output.

When the HK-CTL output is turned on, key inputs due to shorting row pins and column pins will be accepted.

- When the $\text{SI}/\overline{\text{KEY}}$ pin is high, inputting the following code values serially can turn DTMF output on or off.

DTMF output	ON	4	(D1)	1	(D0)
		*	(D3)	7	(D2)
		5	(D5)	5	(D4)
		0	(D7)	8	(D6)
		6	(D9)	3	(D8)
		#	(DB)	9	(DA)
		B	(DD)	A	(DC)
		D	(DF)	C	(DE)
DTMF output	OFF		(4E)		

Other Serial Input Codes

- SREQ (F0 to FF)

These commands output the IC's internal status from the $\overline{\text{SOUT}}$ pin. All the status items are valid.

- 20

Turns key acquisition mode on or off.

- 46 (CLR)

Inputting the CLR code in memory store mode erases all stored dialing data.

- 4A (OHD-ON)

Inputting the OHD-ON code in standby mode switches the system to on-hook dialing mode. Input the DISCON code (4F) to return to standby mode.

- 8D (pause)

This command corresponds to 3.9-second pause data.

- A2 (MC)

Changes the dialing data input mode plug from pulse to tone. This is represented as 1110 in memory.

This is ignored and not written to memory if the dialing data input mode is tone mode.

Note that codes marked as undefined in the serial code table are ignored.

- Notes on serial input usage

- If the $\text{SI}/\overline{\text{KEY}}$ pin is switched from low to high and then to low again while a key is pressed, the LC737212/M will receive two key presses for that key.

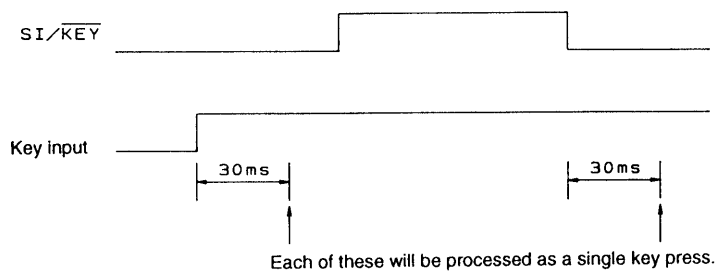

A04292

- TCLKD (The first $\overline{\text{SCLK}}$ input after the $\text{SI}/\overline{\text{KEY}}$ pin goes from low to high)

The LC737212/M monitors the $\overline{\text{SOUT}}$ output after $\text{SI}/\overline{\text{KEY}}$ goes high, and if there is no serial output due to a key press after 3.5 ms or longer has elapsed, then it enables $\overline{\text{SCLK}}$ input. For all other cases, 35 ms or longer is required.

- The IC will reliably output the status data from the $\overline{\text{SOUT}}$ pin if a status request command (FF) or a code 20 command in a mode other than hold or memory store mode is input. If this output does not appear for over 25 ms (in cases other than serial readout from memory), the IC itself may have caused some sort of error. In such cases, the IC must be re-initialized using the $\overline{\text{DISCON}}$ pin.

- We recommend always re-initializing the IC with the $\overline{\text{DISCON}}$ pin when receiving standby status. (At this time, the IC will once again output the standby status data.)

During Store Operations

Off/On-HOOK STORE = 0

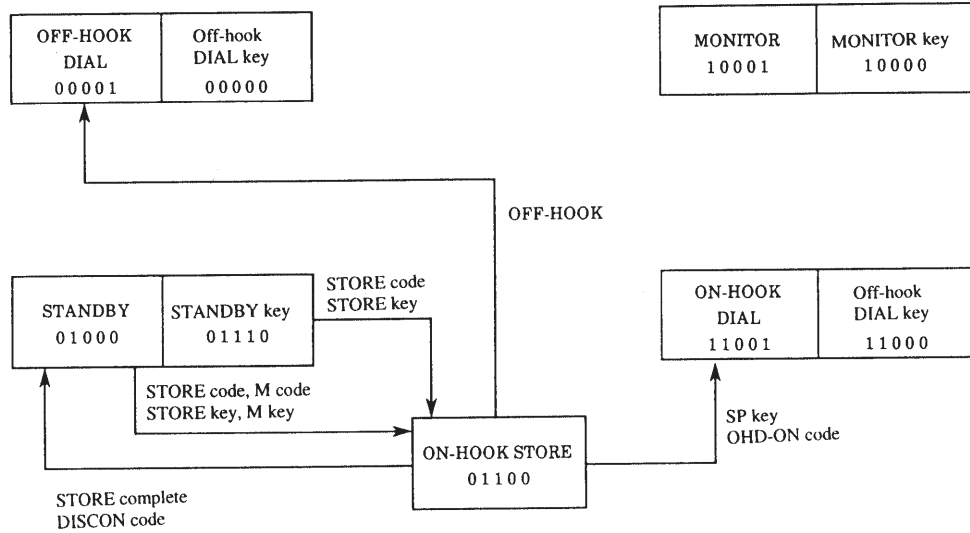

Off/On-HOOK STORE = 1

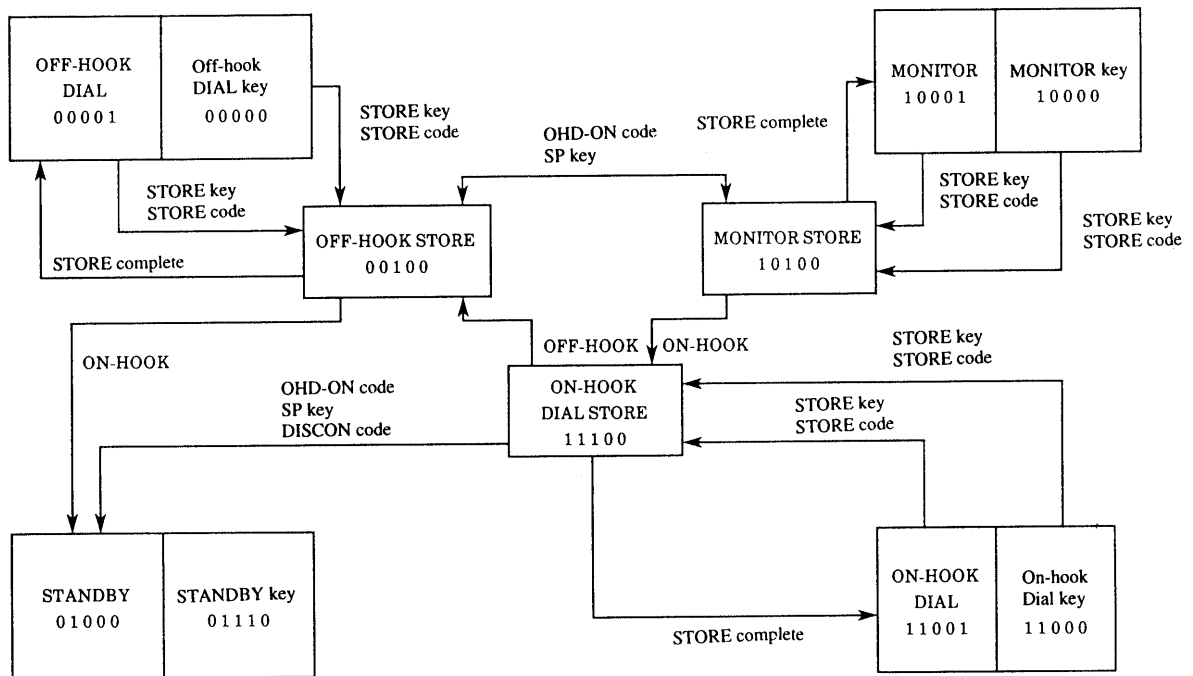

- No products described or contained herein are intended for use in surgical implants, life-support systems, aerospace equipment, nuclear power control systems, vehicles, disaster/crime-prevention equipment and the like, the failure of which may directly or indirectly cause injury, death or property loss.
- Anyone purchasing any products described or contained herein for an above-mentioned use shall:
 - ① Accept full responsibility and indemnify and defend SANYO ELECTRIC CO., LTD., its affiliates, subsidiaries and distributors and all their officers and employees, jointly and severally, against any and all claims and litigation and all damages, cost and expenses associated with such use:
 - ② Not impose any responsibility for any fault or negligence which may be cited in any such claim or litigation on SANYO ELECTRIC CO., LTD., its affiliates, subsidiaries and distributors or any of their officers and employees jointly or severally.
- Information (including circuit diagrams and circuit parameters) herein is for example only; it is not guaranteed for volume production. SANYO believes information herein is accurate and reliable, but no guarantees are made or implied regarding its use or any infringements of intellectual property rights or other rights of third parties.

This catalog provides information as of February, 1998. Specifications and information herein are subject to change without notice.