



LC4105V

Level Shifter

Overview

The LC4105V is a level shifter driver that converts 5-V signals into signals with amplitudes between 10 and 18 V.

Features

- Seven inputs and eleven outputs
IN1 to IN3 produce only true outputs.
IN4 to IN7 produce both true and inverted outputs.
- Slim SSOP-30 package

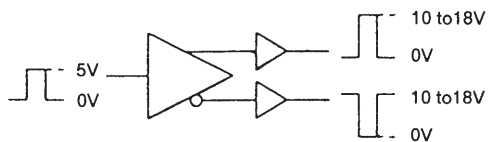

Package Dimensions

unit: mm

3191-SSOP30

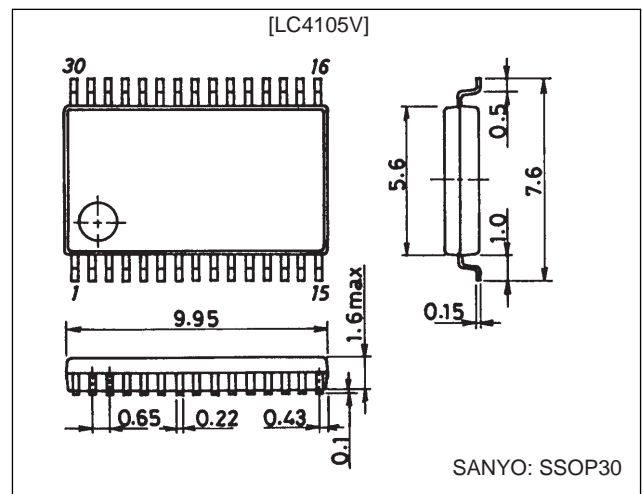

Specifications

Absolute Maximum Ratings at $T_a = 25^\circ\text{C} \pm 2^\circ\text{C}$, all voltages are relative to V_{SS} , unless otherwise specified

Parameter	Symbol	Conditions	Ratings			Unit
			min	typ	max	
Power supply voltage	V_{DD}		-0.3		20	V
	V_{DD1}		-0.3		20	V
	V_{CC}		-0.3		7	V
	V_{SS1}		-0.3		+0.3	V
Input voltage	V_{IN}	IN1 to IN7	-0.5		$V_{CC} + 0.5$	V
Power dissipation	P_d	$T_a \leq 75^\circ\text{C}$			200	mW
Storage temperature	T_{stg}		-55		+125	$^\circ\text{C}$

LC4105V

Allowable Operating Ranges at voltages relative to V_{SS}

Parameter	Symbol	Conditions	Ratings			Unit
			min	typ	max	
Power supply voltage	V_{DD}	*	10		18	V
	V_{DD1}	*		V_{DD}		V
	V_{CC}	*	3.0		5.5	V
	V_{SS1}	*		V_{SS}		V
High-level input voltage	V_{IN-H}	IN1 to IN7 ($V_{CC} = 4.5$ to 5.5 V) ($V_{CC} = 3.0$ to 4.5 V)	2.4		V_{CC}	V
			$0.7 V_{CC}$		V_{CC}	V
Low-level input voltage	V_{IN-L}	IN1 to IN7 ($V_{CC} = 4.5$ to 5.5 V) ($V_{CC} = 3.0$ to 4.5 V)	0		0.8	V
			0		$0.1 V_{CC}$	V
Operating temperature	T_{opr}		-10		+75	°C

Note: * Applications must observe the directions in the note on page 5 at power on and at power off.

Electrical Characteristics

at $T_a = 25^\circ\text{C} \pm 2^\circ\text{C}$, $V_{CC} = 5$ V, and $V_{DD} = 16$ V, all voltages are relative to V_{SS} , unless otherwise specified

Parameter	Symbol	Conditions	Ratings			Unit
			min	typ	max	
High-level input current	I_{ih}	$V_{in} = V_{CC}$ IN1 to IN7			1	μA
Low-level input current	I_{il}	$V_{in} = V_{SS}$ IN1 to IN7	-1			μA
High-level output voltage	V_{oh}	$I_o = 1$ mA	$V_{DD}-1$		V_{DD}	V
Low-level output voltage	V_{ol}	$I_o = -1$ mA	V_{SS}		$V_{SS}+1$	V
Output on resistance	R_{out}	$V_{DD} = V_{DD1} = 10$ V $I_o = \pm 1$ mA		60		Ω
Current drain while idling	I_{CCI}	$V_{DD} = V_{DD1} = 18$ V, $V_{CC} = 5.5$ V		0.01	10	μA
	I_{DDI}^*	IN1 to IN7 = 0 V All outputs open.		0.10	10	μA
Current drain during operation	I_{CCa}	$V_{DD} = V_{DD1} = 15$ V, $V_{CC} = 5.5$ V		16		μA
	I_{DDa}^*	IN0 to IN6 = 0 V IN7 = 0 to 5.5 V/2 MHz Load 1		10		mA

Note: * I_{DDI} and I_{DDa} are the total currents flowing into power supply pins V_{DD} and V_{DD1} .

LC4105V

Pin Assignment

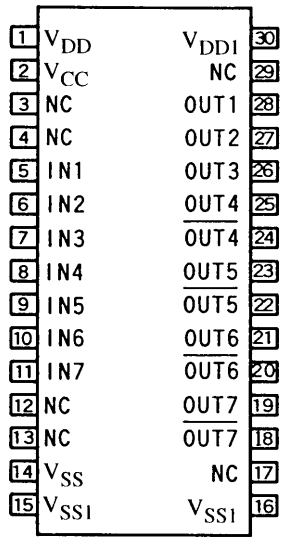

Top view

Block Diagram

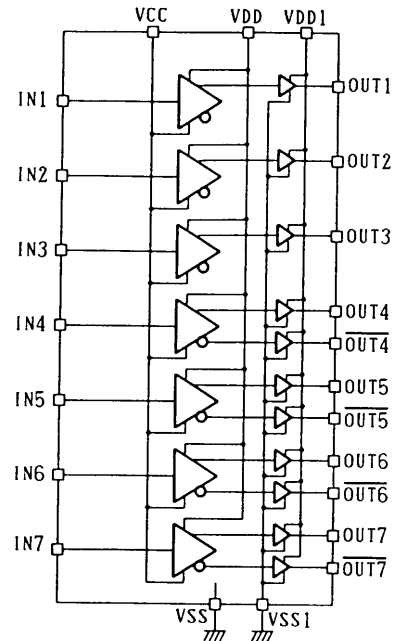

Pin Descriptions

Pin Name	I/O	Pin Number	Function
OUT1	O	28	Level shifter outputs
OUT2		27	
OUT3		26	
OUT4		25	
OUT4*		24	
OUT5		23	
OUT5*		22	
OUT6		21	
OUT6*	20	Level shifter inputs	
OUT7	19		
OUT7*	18		
IN1	I		5
IN2		6	
IN3		7	
IN4		8	
IN5		9	
IN6		10	
IN7		11	
V _{DD}	—	1	Level shifter high-voltage power supply
V _{DD1}	—	30	Buffer high-voltage power supply
V _{CC}	—	2	Level shifter low-voltage power supply
V _{SS1}	—	15, 16	Buffer ground
V _{SS}	—	14	Level shifter ground
NC		3, 4, 12, 13, 17, 29	Do not connect anything to these pins.

LC4105V

Switching Characteristics at $T_a = 25^\circ\text{C} \pm 2^\circ\text{C}$, $V_{CC} = 5\text{ V} \pm 10\%$, $V_{DD} = 10\text{ to }18\text{ V}$

Parameter	Symbol	Conditions	Ratings			Unit
			min	typ	max	
Propagation delay	tpLH(1)	Load 1		33	60	ns
	tpHL(1)			35	60	ns
	tpLH(2)		tpHL(1)-10	36	tpHL(1)+20	ns
	tpHL(2)		tpLH(1)-20	20	tpLH(1)+10	ns
Rising time	tr	Load 1		24	50	ns
Falling time	tf	Load 1		24	50	ns

at $T_a = 25^\circ\text{C} \pm 2^\circ\text{C}$, $V_{CC} = 3.0\text{ to }4.5\text{ V}$, $V_{DD} = 10\text{ to }18\text{ V}$

Parameter	Symbol	Conditions	Ratings			Unit
			min	typ	max	
Propagation delay	tpLH(1)	Load 1			100	ns
	tpHL(1)				120	ns
	tpLH(2)				120	ns
	tpHL(2)				100	ns
Rising time	tr	Load 1			50	ns
Falling time	tf	Load 1			50	ns

Note: The typical values are measured for OUT1 output with $V_{CC} = 5.5\text{ V}$ and $V_{DD} = 15\text{ V}$.

Load 1

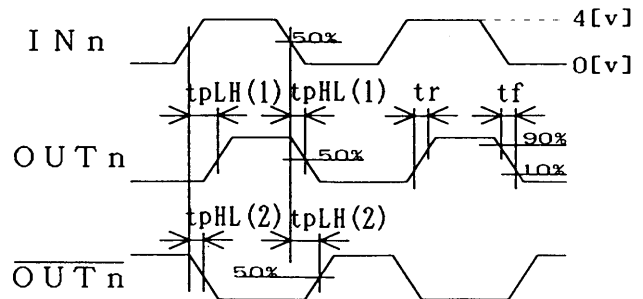
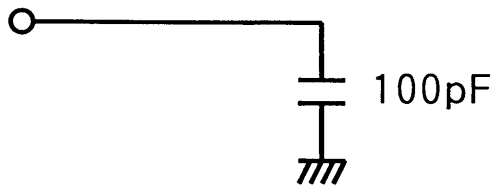

Power Supply Circuits

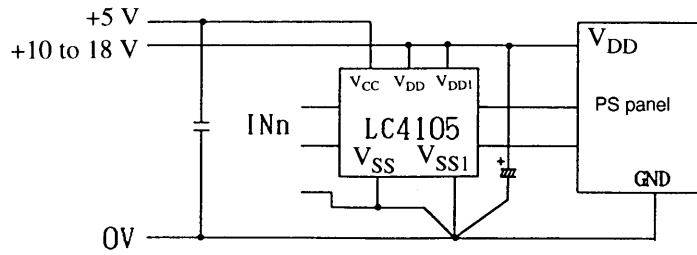

Keep the impedance of the V_{SS} and V_{SS1} lines as low as possible. Connect a large electrolytic capacitor across the V_{DD1} and V_{SS1} pins and close to the IC. Wherever possible, keep the grounds for the power supply circuits and the signal circuits separate and connect the two at a single point.

Notes on Power-Supply Voltage Application

This IC has two power supply systems: V_{DD} (V_{DD1}) and V_{CC} , and requires that applications observe the notes provided here when applying or removing these voltages. In particular, if the V_{DD} (V_{DD1}) system power-supply voltage becomes higher than the V_{CC} system voltage while the V_{CC} system voltage is not yet established (i.e. is less than V_{CCmin}), excessive currents may flow and the IC may be destroyed. To prevent destruction of the IC due to this phenomenon, applications must, basically, follow the sequence described in item 1 below when turning the power supplies on or off.

1. When turning the power on, first apply the V_{CC} voltage (bring this voltage to a value above V_{CCmin}), and then apply the V_{DD} voltage. When turning the power off, first drop the V_{DD} voltage, and, after V_{DD} is below V_{CCmin} , then drop the V_{CC} voltage.

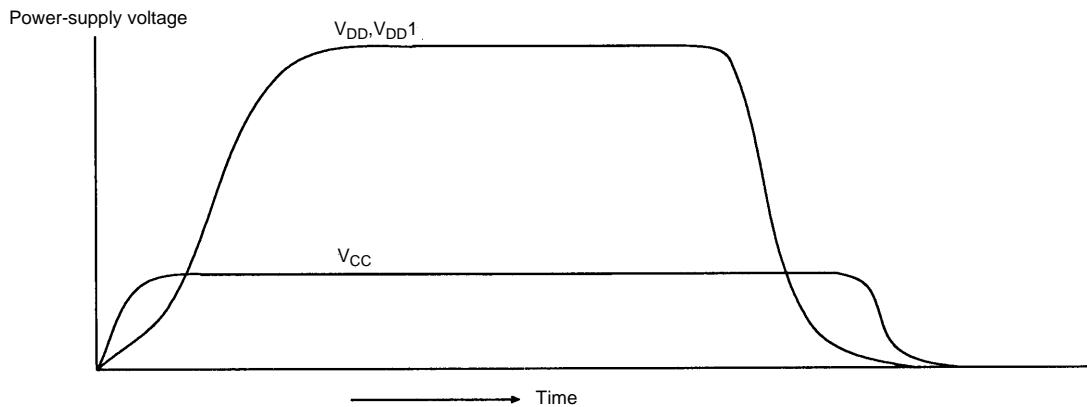

LC4105V

However, there are many cases where it is not possible to control the power-supply voltage on/off sequence. This IC is actually capable of supporting the on/off sequence described in item 2 below.

2. If V_{DD} (V_{DD1}) and V_{CC} are turned on and off at essentially the same time, the difference between V_{DD} and V_{CC} (e.g. the distance in the figure marked as $\Delta 0.5\text{ V}$) must be held to be under 0.5 V while V_{CC} is less than or equal to 3.0 V .

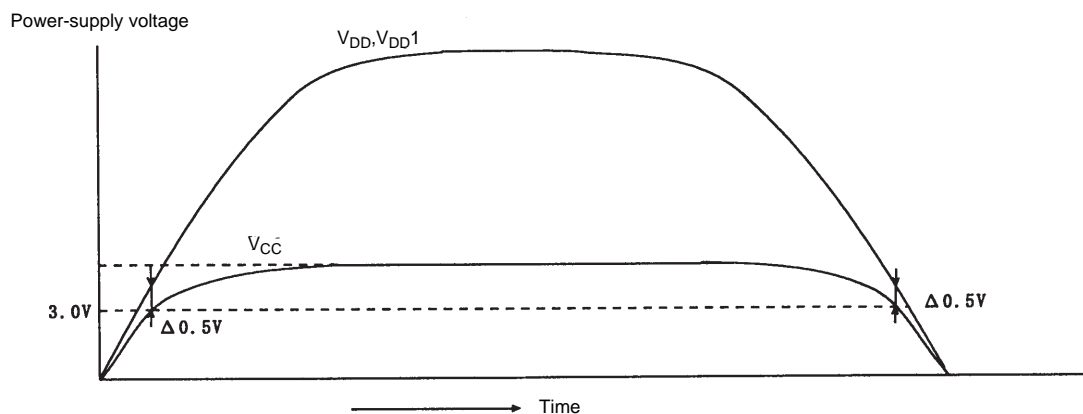

Another point is that a certain amount of time is required to stabilize the V_{CC} system when V_{CC} is first applied and the IC is easily destroyed during this period. Inversely, when the power is removed, the V_{CC} system state is easily retained and as a result the device cannot be destroyed easily. In actual use, one can consider there to be a certain amount of margin for removing the V_{DD} (V_{DD1}) voltage even after V_{CC} has already been dropped. However, this margin varies with sample-to-sample variations in the IC itself and with the details of the application circuit, and careful analysis and consideration of the actual usage conditions is required to assure that the IC will not be destroyed if the sequences in items 1 or 2 are not observed.

3. Note that when power is turned off and then immediately turned back on again, many circuit designs may fail to meet the conditions for the sequences described in items 1 and 2 above. Be sure to take this into account when designing applications that use this IC.

- No products described or contained herein are intended for use in surgical implants, life-support systems, aerospace equipment, nuclear power control systems, vehicles, disaster/crime-prevention equipment and the like, the failure of which may directly or indirectly cause injury, death or property loss.
- Anyone purchasing any products described or contained herein for an above-mentioned use shall:
 - ① Accept full responsibility and indemnify and defend SANYO ELECTRIC CO., LTD., its affiliates, subsidiaries and distributors and all their officers and employees, jointly and severally, against any and all claims and litigation and all damages, cost and expenses associated with such use:
 - ② Not impose any responsibility for any fault or negligence which may be cited in any such claim or litigation on SANYO ELECTRIC CO., LTD., its affiliates, subsidiaries and distributors or any of their officers and employees jointly or severally.
- Information (including circuit diagrams and circuit parameters) herein is for example only; it is not guaranteed for volume production. SANYO believes information herein is accurate and reliable, but no guarantees are made or implied regarding its use or any infringements of intellectual property rights or other rights of third parties.

This catalog provides information as of April, 1998. Specifications and information herein are subject to change without notice.